

## 677

chaves dinamométricas com embraiagem e roquete simples para aperto direito e esquerdo precisão:  $\pm 4\%$



UNI EN ISO 6789

Nm	Kgfm	lbf.ft	D mm	A mm	L mm	kg
100÷500	10÷50	70÷350	70	55	915	5,2

677/50 € 714,00 1 006770050

Nm	Kgfm	lbf.ft	D mm	A mm	L mm	kg
150÷700	15÷70	100÷500	70	55	1140	6,2

677/70 € 747,00 1 006770070

Nm	Kgfm	lbf.ft	D mm	A mm	L mm	kg
300÷1000	30÷100	200÷750	70	55	1470	7,5

677/100 € 774,00 1 006770100

## 677/C

chaves dinamométricas com roquetes móveis para aperto à esquerda e à direita, precisão de torque:  $\pm 4\%$  fornecidas em estojo

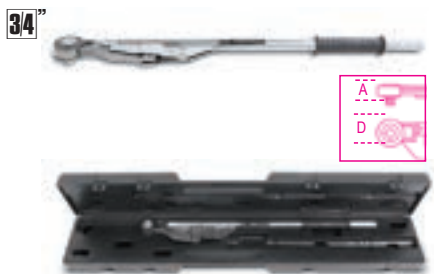

UNI EN 26789  
ISO 6789

Nm	Kgfm	lbf.ft	D mm	A mm	L mm	kg
100÷500	10÷50	70÷350	70	55	915	5,2

677/C50 € 830,00 1 006770606

Nm	Kgfm	lbf.ft	D mm	A mm	L mm	kg
150÷700	15÷70	100÷500	70	55	1140	6,2

677/C70 € 863,00 1 006770611

Nm	Kgfm	lbf.ft	D mm	A mm	L mm	kg
300÷1000	30÷100	200÷750	70	55	1470	7,5

677/C100 € 992,00 1 006770615

Nm	Kgfm	lbf.ft	D mm	A mm	L mm	kg
700÷1500	70÷150	500÷1000	70	70	1475	10,4

677/C150 € 1.275,00 1 006770620

## 677/CP200

chave dinamométrica com embraiagem e roquete simples para aperto à direita e esquerda precisão:  $\pm 4\%$  em estojo



UNI EN ISO 6789

Nm	Kgfm	lbf.in	D mm	A mm	L mm	kg
900÷2000	90÷200	600÷1500	70	63	1920	13

677/CP200 € 2.400,00 1 006770720

## 678/C

chaves dinamométricas com roquetes móveis para aperto à esquerda e à direita precisão  $\pm 4\%$  fornecidas em estojo

• Modelos 678/C100 e 678/C150 fornecidos com extensões.

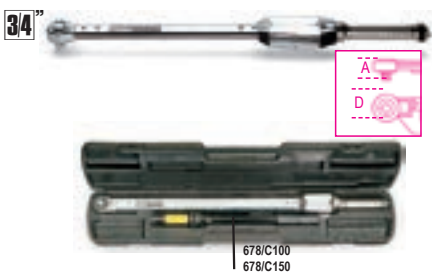

Nm	Kgfm	lbf.ft	D mm	A mm	L mm	kg
130÷650	13÷65	100÷480	63	55	885	3,9

678/C65 € 1.400,00 1 006780607

Nm	Kgfm	lbf.ft	D mm	A mm	L mm	kg
300÷1000	30÷100	220÷750	75	60	1250	6,0

678/C100 € 1.875,00 1 006780611

Nm	Kgfm	lbf.ft	D mm	A mm	L mm	kg
500÷1500	50÷150	370÷1100	75	60	1570	8,5

678/C150 € 2.065,00 1 006780615

## 677/CV - 678/CV

caixas metálicas para chaves dinamométricas modelos 677 e 678



677/CV1 € 116,00 1 006770450

677/C50-677/C70 € 109,00 1 006780500

678/CV2 € 218,00 1 006780415

677/C100-677/C150-678/C150 € 109,00 1 006780415

## 680

controlador eletrônico de binário Dynatester 680 para verificação da calibragem, possibilidade de utilização em sentido horário ou anti-horário

• Precisão:  $\pm 1\%$   
• 3 unidades de medida: Nm - lbf.ft. - lbf.in



	Nm	kg	€		
680/2,5	1÷25	2,6	1.885,00	1	006800002
680/40	15÷400	4,0	1.895,00	1	006800040
680/100	100÷1000	4,8	2.710,00	1	006800100

## 682

controlador de binário electrónico digital com transdutor Dynatester 682, para uso à direita e à esquerda

Alta precisão de leitura  
Fornecido com porta série RS-232 para impressoras



### CARACTERÍSTICAS TÉCNICAS

Precisão de leitura:  $\pm 1\%$  do valor lido

Unidades de medida seleccionáveis

Nm-dNm-cNm-Lbf.ft-Lbf.in-Ozf.in-Kgf.m-Kgf.cm-gf.cm

Alimentação: 90 a 264 V AC a 50/60 Hz

Dimensões: 235x185x185 mm

Tolerância de teste de acordo com a norma ISO 6789

Escala aceite para cada chave dinamométrica testada

Visor: Menu disponível em 11 línguas

Fornecido com todos os certificados necessários

Certificado de calibração com rastreabilidade UKAS

	Nm	kg	€		
682/60	1,2÷60	5,9	5.040,00	1	006820006
682/400	8÷400	6,1	5.120,00	1	006820040
682/1500	30÷1500	6,4	5.280,00	1	006820150

## 710

chaves de impacto série normal



UNI/ISO 2725 DIN 3129

Ø	Ø	L	Ø1	€	Unid.	Art.
mm	mm	mm	mm			
7	12,5	28	19	7,75	3	007100007
8	13,8	28	19	7,75	3	007100008
9	15,0	28	19	7,75	3	007100009
10	16,3	28	19	7,75	3	007100010
11	17,5	30	19	7,75	3	007100011
12	19,0	30	19	7,75	3	007100012
13	20,0	30	22	8,20	3	007100013
14	21,3	30	22	8,20	3	007100014
16	23,8	30	22	8,20	3	007100016
17	25,0	30	22	8,20	3	007100017
18	26,3	30	22	8,55	3	007100018
19	27,5	30	22	8,55	3	007100019
21	30,0	32	22	9,30	3	007100021
22	32,0	32	22	10,20	3	007100022

## 710/16

adaptador quadra fêmea de 3/8" para quadra macho de 1/2"



L	Ø	€	Unid.	Art.
mm	mm			
32	22	21,00	3	007100810

## 710/20

extensões com quadras macho e fêmea de 3/8"



L	Ø	€	Unid.	Art.
mm	mm			
75	22	21,00	2	007100821

## 710/21

extensões com quadras macho e fêmea de 3/8"



L	Ø	€	Unid.	Art.
mm	mm			
125	22	23,20	2	007100823

## 710/25

cardan com quadras macho e fêmea de 3/8"

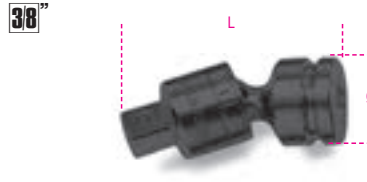

L	Ø	€	Unid.	Art.
mm	mm			
58	24	44,50	2	007100830

## 710/C10

jogo com 10 chaves de impacto



710/C10	€	Unid.	Art.
7-8-10-11-12-13 14-17-19-22 mm	94,50	1	007100910

130x55x40 mm - 800 g

## 710/OR... - 710/SP...

anéis em borracha e cavilhas de fixação para chaves de impacto e acessórios



710/OR1	710	710/16	€	Unid.	Art.
	mm	L mm			
710/OR2	7+12	32	0,65	10	007100922
710/SP1	13+22		0,65	10	007100922
710/SP2	7+12	32	1,15	10	007100911
	13+22	32	1,15	10	007100912

## 720

chaves de impacto série normal



UNI/ISO 2725 DIN 3129

Ø	Ø	L	Ø1	€	Unid.	Art.
mm	mm	mm	mm			
10	17,0	38	25	9,60	5	007200010
11	18,5	38	25	9,60	5	007200011
12	20,0	38	25	9,60	5	007200012
13	21,0	38	25	9,60	5	007200013
14	22,5	38	25	9,60	5	007200014
15	23,0	38	30	10,70	5	007200015
16	25,0	38	30	10,70	5	007200016
17	26,0	38	30	10,70	5	007200017
18	27,5	38	30	10,70	5	007200018
19	28,5	38	30	10,70	5	007200019
21	31,0	38	30	11,90	5	007200021
22	32,5	38	30	11,90	5	007200022
23	34,0	38	30	13,00	5	007200023

Ø	Ø	L	Ø1	€	Unid.	Art.
mm	mm	mm	mm			
24	35,0	38	30	13,00	5	007200024
27	38,5	45	30	15,30	3	007200027
30	42,0	50	30	16,40	3	007200030
32	44,0	50	30	18,60	3	007200032
36	50,0	50	30	27,50	3	007200036

## 720AS

chaves de impacto, série normal



Ø	Ø	L	Ø1	€	Unid.	Art.
mm	mm	mm	mm			
3/8	17,0	38	25	15,60	2	007200210
7/16	18,2	38	25	15,60	2	007200211
1/2	20,7	38	25	15,60	2	007200213
9/16	22,0	38	25	15,60	2	007200214
5/8	24,5	38	30	16,70	2	007200216
11/16	25,7	38	30	16,70	2	007200217
3/4	28,2	38	30	16,70	2	007200219
13/16	30,7	38	30	17,90	2	007200221
7/8	32,0	38	30	17,90	2	007200222
15/16	34,5	38	30	19,00	2	007200224
1	35,7	38	30	20,20	2	007200225
1.1/16	38,2	40	30	22,10	1	007200227
1.1/8	40,7	42	30	24,90	1	007200229
1.1/4	44,5	42	30	27,00	1	007200232

## 720L

chaves de impacto série longa



UNI/ISO 2725

Ø	Ø	L	Ø1	€	Unid.	Art.
mm	mm	mm	mm			
10	17,0	80	25	16,50	2	007200310
11	18,5	80	25	16,50	2	007200311
12	20,0	80	25	16,50	2	007200312
13	21,0	80	25	16,50	2	007200313
14	22,5	80	25	16,50	2	007200314
15	23,0	80	30	18,70	2	007200315
16	25,0	80	30	18,70	2	007200316
17	26,0	80	30	18,70	2	007200317
18	27,5	80	30	19,80	2	007200318
19	28,5	80	30	19,80	2	007200319
21	31,0	80	30	21,00	2	007200321
22	32,5	80	30	21,00	2	007200322
24	35,0	80	30	21,50	2	007200324
27	38,5	80	30	26,50	2	007200327
30	42,0	80	30	34,00	2	007200330
32	44,0	80	30	34,00	2	007200332
36	50,0	80	30	51,50	2	007200336

## 720L/S3

jogo de 3 chaves de impacto 720L



Ø	€	Unid.	Art.
mm			
17-19-21	59,50	1	007200355

## 720LS

chaves de impacto, série longa



UNI/ISO 2725

mm	Ø mm	L mm	Ø1 mm	€	🔧	📦
10	15,5	78	24	17,80	2	007200360
11	16,7	78	24	17,80	2	007200361
12	18,0	78	24	17,80	2	007200362
13	19,2	78	24	17,80	2	007200363
14	20,5	78	24	17,80	2	007200364
15	21,7	78	24	20,40	2	007200365
16	23,0	78	24	20,40	2	007200366
17	24,2	78	29	20,40	2	007200367
18	25,5	78	29	22,10	2	007200368
19	26,7	78	29	22,10	2	007200369
21	29,2	78	29	23,20	2	007200371
22	30,5	78	29	23,20	2	007200372
24	33,0	78	29	23,70	2	007200374
27	36,7	78	29	29,00	2	007200377
30	40,5	78	29	37,00	2	007200380
32	43,0	78	29	37,00	2	007200382
36	48,0	78	29	57,00	2	007200386

## 720LC

chaves de impacto para porcas de roda, com inserts coloridos em polímero



mm	Ø mm	€	🔧	📦
17	26,5	11,50	2	007200637
19	28,5	11,50	2	007200639
21	30,3	12,00	2	007200641
22	32,4	12,60	2	007200642
24	34,6	13,70	2	007200644



720LC/C3	€	🔧	📦
17-19-21 mm	35,00	1	007200653

148x132x44 mm - 860 g



720LC/S5	€	🔧	📦
17-19-21-22-24 mm	61,50	1	007200645

## 720IC

inserts sobresselentes coloridos em polímero para chaves de impacto 720LC-720LCL



	mm	€	🔧	📦
720IC 17	17	4,40	1	007200687
720IC 19	19	4,40	1	007200689
720IC 21	21	4,40	1	007200691
720IC 22	22	4,40	1	007200692
720IC 24	24	4,40	1	007200694

## 720LCL

chaves de impacto para porcas de roda, com inserts coloridos em polímero, série longa



mm	Ø mm	€	🔧	📦
17	26,5	19,10	1	007200737
19	28,5	19,10	1	007200739
21	30,3	19,10	1	007200741



720LCL/C3	€	🔧	📦
17-19-21 mm	73,50	1	007200753

210x50x150 mm - 1,65 kg

## 720MRC

chave de impacto com insert polimérico parafusos de rodas Mercedes



mm	Ø mm	L mm	€	🔧	📦
17	27	85	17,50	1	007200631

## 720TC

barras de torção de impacto, coloridas, para porcas de rodas de automóveis, com quadras macho e fêmea 1/2



Nm	L mm	€	🔧	📦
90	200	19,10	1	007200769
100	200	19,10	1	007200770
110	200	19,10	1	007200771
120	200	19,10	1	007200772
135	200	19,10	1	007200773



720TC/S5	€	🔧	📦
90-100-110-120-135 Nm	95,50	1	007200779

260x50x175 mm - 1,35 kg

## 720FTX

chaves de caixa para parafusos com perfil Torx®



	Ø mm	L mm	Ø1 mm	€	🔧	📦
E10	14,0	38	25	15,30	2	007200410
E12	15,9	38	25	15,30	2	007200412
E14	17,7	38	25	15,30	2	007200414
E16	20,0	38	25	15,30	2	007200416
E18	22,0	38	25	15,30	2	007200418
E20	25,0	40	25	16,40	2	007200420



720FTX/SB6	€	🔧	📦
E10-E12-E14 E16-E18-E20	101,00	1	007200450

## 720TX

chaves de impacto para parafusos Torx®



	Ø mm	L mm	L1 mm	€	🔧	📦
T30	25	78	54	13,20	3	007200460
T40	25	78	54	13,20	3	007200470
T45	25	78	54	13,70	3	007200472
T50	25	78	54	13,70	3	007200474
T55	25	78	54	15,30	3	007200476
T60	25	78	54	16,40	3	007200478

## 720TX/C6

jogo de 6 chaves de impacto para parafusos Torx® em caixa metálica



720TX/C6 111,00 € 1 007200483  
T30-T40-T45  
T50-T55-T60

275x120x65 mm - 5700 g

## 720ME

chaves de impacto sextavadas



mm	Ø mm	L mm	L1 mm	€		
5	25	78	54	12,70	3	007200505
6	25	78	54	12,70	3	007200506
8	25	78	54	12,70	3	007200508
10	25	78	54	12,70	3	007200510
12	25	78	54	12,70	3	007200512
14	25	78	54	14,50	3	007200514
17	25	78	54	14,50	3	007200517
19	25	78	54	14,50	3	007200519

## 720ME/C8

jogo de 8 chaves de impacto sextavadas



720ME/C8 133,00 € 1 007200525  
5-6-8-10-12  
14-17-19 mm

270x120x45 mm - 1710 g

## 720/15

adaptador quadra fêmea de 1/2" para quadra macho de 3/8"



L mm	Ø mm	□	■	€		
37,5	25	1/2	3/8	13,70	3	007200810



Aplique sempre uma força de aperto regular e progressiva, a fim de evitar a ruptura do material e de se proteger de um possível acidente

## 720/16

adaptador quadra fêmea de 1/2" para quadra macho de 3/4"



L mm	Ø mm	□	■	€		
44	30	1/2	3/4	18,60	3	007200814

## 720/20

extensões com quadras macho e fêmea de 1/2"



L mm	Ø mm	€		
75	25	18,90	3	007200818

## 720/21

extensões com quadras macho e fêmea de 1/2"



L mm	Ø mm	€		
125	25	20,50	3	007200822

## 720/25

cardan com quadras macho e fêmea de 1/2"



L mm	Ø mm	€		
64	28	40,00	2	007200831

## 720/C6

jogo com 6 chaves de impacto



720/C6 83,00 € 1 007200910  
13-14-17-19-22-24 mm

195x80x55 mm - 1100 g

## 720/C12

jogo com 12 chaves de impacto



720/C12 162,00 € 1 007200912  
10-11-12-13-14-17  
19-22-24-27-30-32 mm

195x80x55 mm - 2000 g

## 720/OR... - 720/SP...

anéis em borracha e cavilhas de fixação para chaves de impacto e acessórios

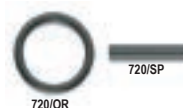

	720 mm	720TX	€		
720/OR1	10+14	T30+T60	1,15	10	007200923
720/OR2	15+32		1,15	10	007200924
720/SP1	10+14	T30+T60	1,75	10	007200913
720/SP2	15+32		1,75	10	007200914

## 727PI/16

chave porta-pontas de impacto 16 mm para os artigos 727/ES16 e 727/ES16TX



Ø mm	L mm	□	■	€		
44	52	16	3/4	41,50	2	007270016

# Beta

## 727/ES16

pontas de impacto sextavados 16 mm



mm	Ø mm	L mm	€	🔧	📦
10	16	40	14,00	2	007270110
12	16	40	14,00	2	007270112
13	16	40	14,00	2	007270113
14	16	40	14,00	2	007270114
16	16	40	15,10	2	007270116
17	16	40	15,10	2	007270117
18	16	40	15,60	2	007270118
19	16	40	15,60	2	007270119
22	16	40	18,00	2	007270122

## 727/ES16TX

pontas de impacto 16 mm para parafusos Torx®



mm	Ø mm	L mm	€	🔧	📦
T55	16	50	21,00	2	007270355
T60	16	50	21,00	2	007270360
T70	16	50	21,00	2	007270370

## 727PI/22

chave porta-pontas de impacto 22 mm para os artigos 727/ES22 e 727/ES22TX

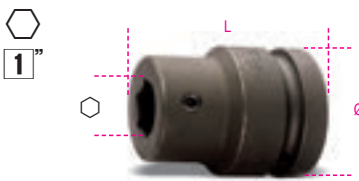

Ø mm	L mm	Ø1 mm	€	🔧	📦
54	70	22	65,00	2	007270022

## 727/ES22

pontas de impacto sextavados 22 mm



mm	Ø mm	L mm	€	🔧	📦
19	22	50	18,00	2	007270219
22	22	50	18,00	2	007270222
24	22	50	19,90	2	007270224
27	22	50	22,10	2	007270227
30	22	50	26,50	2	007270230
32	22	50	29,00	2	007270232

## 727/ES22TX

pontas de impacto 22 mm para parafusos Torx®



mm	Ø mm	L mm	€	🔧	📦
T80	22	60	29,50	2	007270480
T90	22	60	29,50	2	007270490
T100	22	60	29,50	2	007270500

## 727/C16

jogo com 12 pontas de impacto e 4 acessórios



727/C16	€	🔧	📦
727/C16	398,00	1	007270900

727PI/16

727/ES16 14-17-19 mm

727/ES16TX T55-T60-T70

727PI/22

727/ES22 22-24-27 mm

727/ES22TX T80-T90-T100

96BPC 3-4 mm

335x145x60 mm - 3,6 kg

## 727PI/32

chave porta-pontas de impacto 32 mm para os artigos 727/ES22 e 727/ES22TX

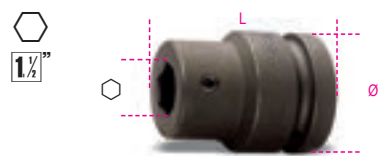

Ø mm	L mm	Ø1 mm	€	🔧	📦
86	66	32	159,00	1	007270032

## 727/ES32

pontas de impacto sextavados 32 mm

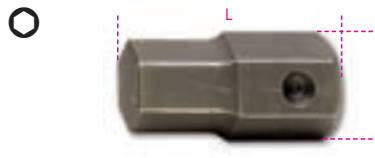

mm	Ø mm	L mm	€	🔧	📦
19	32	44	41,00	2	007270519
22	32	44	41,00	2	007270522
24	32	44	41,00	2	007270524
27	32	44	41,00	2	007270527
30	32	44	41,00	2	007270530
32	32	44	41,00	2	007270532
36	32	44	46,00	2	007270536

## 728

chaves de impacto série normal



UNI/ISO 2725 DIN 3129

mm	Ø mm	L mm	Ø1 mm	€	🔧	📦
17	30,0	51	44	23,50	2	007280017
18	31,0	51	44	23,50	2	007280018
19	32,5	51	44	23,50	2	007280019
21	35,0	51	44	23,50	2	007280021
22	36,0	51	44	23,50	2	007280022
23	37,5	51	44	24,00	2	007280023
24	38,5	51	44	24,00	2	007280024
27	42,5	53	44	24,00	2	007280027
28	44,0	53	44	24,90	2	007280028
30	46,0	53	44	24,90	2	007280030
32	48,5	57	44	26,00	2	007280032
33	50,0	57	44	28,50	2	007280033
34	51,0	57	44	28,50	2	007280034
35	52,5	57	44	29,00	2	007280035
36	53,5	57	44	30,00	2	007280036
38	56,0	57	44	33,50	1	007280038
40	58,5	58	44	36,00	1	007280040
41	60,0	58	44	36,00	1	007280041
44	64,0	62	44	40,00	1	007280044
45	65,0	62	44	43,00	1	007280045
46	66,0	62	44	43,00	1	007280046
50	71,0	68	54	51,50	1	007280050
55	77,5	71	54	56,50	1	007280055
60	83,0	73	54	64,00	1	007280060
65	88,0	78	54	71,50	1	007280065

## 728FTX

chave de impacto para parafusos de perfil Torx®

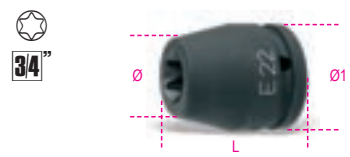

mm	Ø mm	L mm	Ø1 mm	€	🔧	📦
E20	28,5	50	44	31,00	2	007280420
E22	30,0	50	44	31,00	2	007280422
E24	32,5	50	44	31,00	2	007280424

## 728L

chaves de impacto série longa

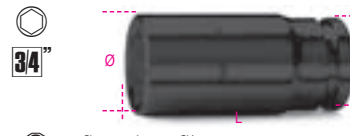

mm	Ø mm	L mm	Ø1 mm	€	🔧	📦
19	32,5	90	44	37,50	2	007280319
21	35,0	90	44	37,50	2	007280321
22	36,0	90	44	37,50	2	007280322
24	38,5	90	44	37,50	2	007280324
26	41,0	90	44	37,50	2	007280326
27	42,5	90	44	37,50	2	007280327
30	46,0	90	44	39,00	2	007280330
32	48,5	90	44	41,00	2	007280332
33	50,0	90	44	44,00	1	007280333
34	51,0	90	44	46,00	1	007280334
36	53,5	90	44	49,00	1	007280336
38	56,0	90	44	54,00	1	007280338
41	60,0	90	44	57,00	1	007280341
46	66,0	90	44	65,50	1	007280346
50	71,0	90	44	78,00	1	007280350
55	77,5	100	54	101,50	1	007280355

## 728LS

chaves de impacto série longa com paredes finas



mm	Ø	L	Ø1	€	U	IT
17	28,0	100	43	42,00	2	007280517
19	30,5	100	43	42,00	2	007280519
22	34,3	100	43	42,00	2	007280522
24	36,8	100	43	42,00	2	007280524
27	40,5	100	43	42,00	2	007280527
30	44,3	100	43	42,00	2	007280530
32	46,8	100	43	46,50	2	007280532
33	48,0	100	43	46,50	2	007280533
36	51,8	100	43	54,00	1	007280536

## 728LQ

chaves de impacto, série longa

(para porcas de rodas ISUZU)



mm	L	Ø	Ø1	€	U	IT
19	90	35	43,5	36,00	1	007280619
21	90	42	43,5	36,00	1	007280621

## 728/15

redução quadra fêmea de 3/4" para quadra macho de 1/2"



L	Ø	□	■	€	U	IT
58	38	3/4	1/2	29,00	2	007280810



Aplique sempre uma força de aperto regular e progressiva, a fim de evitar a ruptura do material e de se proteger de um possível acidente

## 728/16

adaptador quadra fêmea de 3/4" para quadra macho de 1"



L	Ø	□	■	€	U	IT
62	44	3/4	1	35,50	2	007280813

## 728/21

extensões com quadras macho e fêmea de 3/4"



L	Ø	€	U	IT
175	44	43,50	2	007280815

## 728/22

extensões com quadras macho e fêmea de 3/4"



L	Ø	€	U	IT
250	44	50,00	2	007280825

## 728/22L

extensões com quadras macho e fêmea de 3/4"



L	Ø	€	U	IT
330	44	63,50	1	007280826

## 728/25

cardan com quadras macho e fêmea de 3/4"



L	Ø	€	U	IT
107,5	44	84,00	1	007280830

## 728/C10

jogo com 10 chaves de impacto



728/C10	€	U	IT
17-19-22-24-27-30 32-36-41-46 mm	305,00	1	007280910

275x120x65 mm - 5,7 kg

## 728/OR - 728/SP

anéis em borracha e cavilhas de fixação para chaves de impacto e acessórios



728/OR	728/SP	728FTX	€	U	IT
728/15			1,70	5	007280925
17+46	E20+E24		1,80	10	007280926
17+46	E20+E24		2,40	10	007280916

## 729

chaves de impacto série normal



UNI/ISO 2725 DIN 3129

mm	Ø	L	Ø1	€	U	IT
24	41,5	58	54	37,50	1	007290024
27	45,0	60	54	37,50	1	007290027
30	49,0	62	54	37,50	1	007290030
32	51,5	63	54	38,50	1	007290032
33	52,5	63	54	38,50	1	007290033
34	54,0	63	54	38,50	1	007290034
36	56,5	66	54	38,50	1	007290036
38	59,0	66	54	46,50	1	007290038
41	62,5	68	54	47,50	1	007290041
46	69,0	72	54	53,00	1	007290046
50	74,0	76	54	65,50	1	007290050
55	80,0	84	54	70,50	1	007290055
60	86,5	88	54	86,00	1	007290060
65	92,5	92	54	98,00	1	007290065
70	99,0	96	54	117,00	1	007290070
75	105,0	102	63	145,00	1	007290075
80	111,5	102	63	156,00	1	007290080

## 729L

chaves de impacto série longa



mm	Ø	L	Ø1	€	U	IT
24	41,5	108	54	66,50	1	007290324
27	45,0	108	54	66,50	1	007290327
30	49,0	108	54	66,50	1	007290330
32	51,5	108	54	66,50	1	007290332
33	52,2	108	54	66,50	1	007290333
34	54,0	108	54	66,50	1	007290334
36	56,5	108	54	66,50	1	007290336
41	62,5	108	54	80,50	1	007290341
46	69,0	108	54	93,00	1	007290346
50	74,0	108	54	104,00	1	007290350
55	80,0	108	54	125,00	1	007290355
60	86,5	108	54	136,00	1	007290360
65	92,5	108	54	164,00	1	007290365
70	99,0	108	54	187,00	1	007290370
75	105,0	108	63	210,00	1	007290375
80	111,5	108	63	221,00	1	007290380

 **Beta**

 **Beta**

## 729LS

chaves de impacto série longa com paredes finas



mm	Ø mm	L mm	Ø1 mm	€	🔧	📄
22	36,0	108	53	66,50	1	007290522
24	38,5	108	53	66,50	1	007290524
27	42,3	108	53	66,50	1	007290527
30	46,0	108	53	70,50	1	007290530
32	48,5	108	53	70,50	1	007290532
33	49,8	108	53	70,50	1	007290533
36	53,5	108	53	70,50	1	007290536

## 729T

barra de torção de impacto para cubos de roda



mm	Nm	L mm	€	🔧	📄
24	350	300	121,00	1	007290724
27	450	300	121,00	1	007290757
30	500	300	123,00	1	007290730
32	450	300	125,00	1	007290732
32	600	300	125,00	1	007290762
33	600	300	131,00	1	007290763
36	600	300	138,00	1	007290736

## 729/15

redução quadra fêmea de 1" para quadra macho de 3/4"



L mm	Ø mm	□	■	€	🔧	📄
66,5	54	1	3/4	45,00	1	007290810



Aplique sempre uma força de aperto regular e progressiva, a fim de evitar a ruptura do material e de se proteger de um possível acidente

## 729/16

redução quadra fêmea de 1" para quadra macho de 1.1/2"



L mm	Ø mm	□	■	€	🔧	📄
88	54,0	1	1.1/2	75,00	1	007290813

## 729/21

extensões com quadras macho e fêmea de 1"



L mm	Ø mm	€	🔧	📄
175	54	70,00	1	007290815

## 729/22

extensões com quadras macho e fêmea de 1"



L mm	Ø mm	€	🔧	📄
330	54	100,50	1	007290825

## 729/25

cardan com quadras macho e fêmea de 1"



L mm	Ø mm	€	🔧	📄
130	54	147,00	1	007290830

## 729/OR... - 729/SP...

anéis em borracha e cavilhas de fixação para chaves de impacto e acessórios



	728 mm	729-730 mm	€	🔧	📄
729/OR1	50+60	24+70	1,80	5	007290927
729/OR2	75+125		2,85	5	007290928
729/SP1	50+60	24+70	1,70	5	007290917
729/SP2	75+125		2,95	5	007290918

## 730

chaves de impacto série normal



UNI/ISO 2725 DIN 3129

mm	Ø mm	L mm	Ø1 mm	€	🔧	📄
50	81	87	84	190,00	1	007300050
55	88	90	86	202,00	1	007300055
60	94	95	86	218,00	1	007300060
65	100	100	86	247,00	1	007300065
70	106	105	86	292,00	1	007300070
75	113	110	86	336,00	1	007300075
80	119	115	86	386,00	1	007300080
85	125	120	86	431,00	1	007300085
90	132	125	86	487,00	1	007300090
95	138	125	96	571,00	1	007300095
100	144	130	96	660,00	1	007300100
105	150	135	96	738,00	1	007300105
110	157	140	96	799,00	1	007300110
115	163	140	96	861,00	1	007300115
120	169	145	96	962,00	1	007300120
125	175	145	96	1.007,00	1	007300125

## 730/15

adaptadores



L mm	Ø mm	□	■	€	🔧	📄
105	84,0	1.1/2	1	151,00	1	007300810



Aplique sempre uma força de aperto regular e progressiva, a fim de evitar a ruptura do material e de se proteger de um possível acidente

## 733/15

adaptadores



L mm	Ø mm	□	■	€	🔧	📄
156	127	2.1/2	1.1/2	548,00	1	007330810

## 851

porta pontas magnético com punho

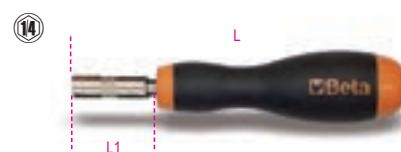

L1 mm	L mm	€	🔧	📄
45	165	13,90	2	008510165
125	245	16,20	2	008510245

## 851SR

porta-pontas de desengate rápido com punho



L	L1	€	U	U
mm	mm			
230	110	19,10	2	008510001

## 852

porta-bits, com cabo articulado em T

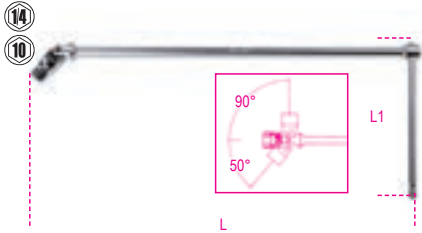

Ø	L	L1	€	U	U
mm	mm	mm			
1/4"	400	160	37,00	2	008520006
10 mm	400	160	37,00	2	008520010

## 855P

punho porta-pontas com roquete reversível, articulado, com 7 bits integrados



L	L1	€	U	U
mm	mm			
240	100	65,00	1	008550010

	+	860PH	PH1 - PH2
	+	860PZ	PZ1 - PZ2
	●	860LP	LP 0,8x5,5 mm
	○	860PE	4 - 5 mm

## 860LP

bits para parafusos ranhurados, coloridos



SxA	L	€	U	U
mm	mm			
0,5x3	25	1,70	5	008600005
0,6x4,5	25	1,70	5	008600010
0,8x5,5	25	1,70	5	008600015
1x5,5	25	1,70	5	008600020
1,2x6,5	25	1,70	5	008600025

## 860PH

bits para parafusos Phillips®, coloridos



ISO 2351-2  
ISO 1173 C 6,3

PH	L	€	U	U
	mm			
0	25	1,70	5	008600220
1	25	1,70	5	008600225
2	25	1,70	5	008600230
3	25	1,70	5	008600245
4	25	2,50	5	008600250

## 860PZ

bits para parafusos Pozidriv® - Supadriv®, coloridos



ISO 2351-2  
ISO 1173 C 6,3

PZ	L	€	U	U
	mm			
1	25	1,70	5	008600320
2	25	1,70	5	008600325
3	25	1,70	5	008600330
4	25	2,50	5	008600335

## 860PE

bits sextavados para aparafusadoras eléctricas, coloridos



ISO 2351-3  
ISO 1173 C 6,3

mm	L	€	U	U
	mm			
2	25	1,80	5	008600101
2,5	25	1,80	5	008600102
3	25	1,80	5	008600103
4	25	1,80	5	008600104
5	25	1,80	5	008600105
6	25	1,80	5	008600106
8	25	2,25	5	008600108
10	25	2,25	5	008600110

## 860TX

bits para parafusos Torx®, coloridos



ISO 1173 C 6,3

Ø	L	€	U	U
	mm			
T6	25	2,25	5	008600704
T7	25	2,25	5	008600705
T8	25	2,25	5	008600710
T9	25	2,25	5	008600715
T10	25	1,80	5	008600720
T15	25	1,80	5	008600725
T20	25	1,80	5	008600730
T25	25	1,80	5	008600735
T27	25	1,80	5	008600740
T30	25	1,80	5	008600745
T40	25	1,80	5	008600750

## 860RTX

bits para parafusos invioláveis Torx®, coloridos



ISO 1173 C 6,3

Ø	L	€	U	U
	mm			
T9	25	2,50	5	008600550
T10	25	2,50	5	008600555
T15	25	2,50	5	008600560
T20	25	2,50	5	008600565
T25	25	2,50	5	008600570
T27	25	2,50	5	008600575
T30	25	2,50	5	008600580
T40	25	2,50	5	008600585

## 860/55

chave de bits reversível



L	Ø	€	U	U
mm	mm			
100	1/4"	28,00	3	008600870

## 860/58

roquete com punho rotativo

• O bit encaixa em ambos os lados, para aparafusar ou desaparafusar  
• Punho bi-material



L	Ø	A	€	U	U		
mm	mm	mm					
860/58	126	1/4"	27	15	65,00	1	008600884



## 860/C27

jogo de 25 bits, 1 conector e 1 roquete reversível em estojo de plástico



860/C27 € 77,50 1 008600880

	860/55	100 mm	
	860LP	0,5x3-1,0x5,5-1,2x6,5 mm	
	860PH	PH1-PH2(x2)-PH3	
	860PZ	PZ1-PZ2(x2)-PZ3	
	860PE	2-2,5-3-4-5-6 mm	
	860TX	T6-T8-T10-T15-T20-T25-T30-T40	
	892/0	● 1/4 ■ 1/4	

## 860PHZ/A10

jogo de 10 pontas com porta pontas magnético em caixa plástica



860PHZ/A10 € 32,50 1 008600910

	860PH	PH1 PH2 PH3	n. 1 3 1
	860PZ	PZ1 PZ2 PZ3	1 3 1
	882M1	○ 1/4 ● 1/4	

## 860PE/A10

jogo de 10 pontas com porta pontas magnético em caixa plástica



860PE/A10 € 34,00 1 008600920

	860PE	2 - 2,5 mm	n. 1
	882M1	3 - 4 - 5 - 6 mm ○ 1/4 ● 1/4	2

## 860TX/A10

jogo de 10 pontas com porta pontas magnético em caixa plástica



860TX/A10 € 34,50 1 008600970

	860TX	T7 - T8 - T9 - T10 - T15 - T20 T25 - T27 - T30 - T40	n. 1
	882M1	○ 1/4 ● 1/4	

## 860MIX/A10

jogo de 10 pontas com porta pontas magnético em caixa plástica



860MIX/A10 € 32,50 1 008600900

	860LP	0,5x3 - 1x5,5 - 1,2x6,5 mm	n. 1
	860PH	PH1 PH2 PH3	1 2 1
	860PZ	PZ1 - PZ2 - PZ3	1
	882M1	○ 1/4 ● 1/4	

## 860MIX/A31

jogo de 30 pontas com porta pontas magnético de desengate rápido em caixa plástica



860MIX/A31 € 76,50 1 008600902

	860LP	0,5x3 - 0,6x4 - 0,8x5,5 1,0x5,5 - 1,2x6,5 mm	
	860PE	2 - 2,5 - 3 - 4 - 5 - 6 8 - 10 mm	
	860PH	PH0 - PH1 - PH2 - PH3 - PH4	
	860PZ	PZ1 - PZ2 - PZ3 - PZ4	
	860RTX	T9 - T10 - T15 - T20 T25 - T27 - T30 - T40	
	882MSR/50	○ 1/4 ● 1/4	

## 860/C38P

1 punho porta-pontas com roquete reversível, 27 bits, 8 chaves de caixa sextavadas e 2 acessórios em estojo de metal com tabuleiro maleável

porta-pontas com roquete reversível  
tampa porta-bits  
barra de extensão amovível de montagem rápida



860/C38P € 169,00 1 008600878

	860LP	0,6x4,5 - 0,8x5,5 - 1,0x5,5 - 1,2x6,5 mm	
	860PE	2-2,5-3-4(x2)-5(x2)	
	860PH	PH1(x2)-PH2(x2)-PH3	
	860PZ	PZ1(x2)-PZ2(x2)-PZ3	
	860TX	T10-T15-T20-T25-T30-T40	
	900	5-5,5-6-7-8-9-10-13 mm	
	892/0	● 1/4 ■ 1/4	
	892/3	● 1/4 ■ 1/4	
	855P	240 mm	

270x120x45 mm

# Beta

## 861LP

pontas para parafusos de fenda



ISO 2351-1

ISO 1173 C 6,3

SxA mm	L mm	€	10	200
0,5x3	25	1,10	10	008610005
0,6x4	25	1,10	10	008610007
0,6x4,5	25	1,10	10	008610010
0,8x5,5	25	1,10	10	008610015
1x5,5	25	1,10	10	008610020
1,2x6,5	25	1,10	10	008610025
1,2x8	25	2,10	10	008610028
1,6x8	25	2,10	10	008610030

## 861PH

pontas para parafusos de perfil Phillips®



ISO 2351-2

ISO 1173 C 6,3

PH	L mm	€	10	200
0	25	1,10	10	008610200
1	25	1,10	10	008610205
2	25	1,10	10	008610210
2L	50	2,10	10	008610213
3	25	1,10	10	008610215
4	25	2,90	10	008610220

## 861PH/C

pontas para parafusos de perfil Phillips®

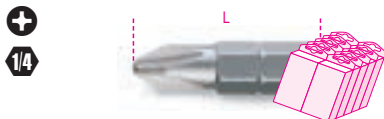

ISO 2351-2

ISO 1173 C 6,3

PH	L mm	€	200	1000
0	25	0,80	200	008610250
1	25	0,80	200	008610255
2	25	0,80	200	008610260
2L	50	1,55	100	008610263
3	25	0,80	200	008610265
4	25	2,10	100	008610270

## 861PZ

pontas para parafusos de perfil Pozidriv® - Supadriv®



ISO 2351-2

ISO 1173 C 6,3

PZ	L mm	€	10	200
1	25	1,10	10	008610300
2	25	1,10	10	008610305
2L	50	2,10	10	008610308
3	25	1,10	10	008610310
4	25	2,90	10	008610315

## 861PZ/C

pontas para parafusos de perfil Pozidriv® - Supadriv®



ISO 2351-2

ISO 1173 C 6,3

PZ	L mm	€	200	1000
1	25	0,80	200	008610350
2	25	0,80	200	008610355
2L	50	1,55	100	008610358
3	25	0,80	200	008610360
4	25	2,10	100	008610365

## 861PE

pontas macho hexagonal



ISO 2351-3

ISO 1173 C 6,3

mm	L mm	€	10	200
2	25	1,15	10	008610100
2,5	25	1,15	10	008610105
3	25	1,15	10	008610110
4	25	1,15	10	008610115
5	25	1,15	10	008610120
6	25	1,15	10	008610125
8	25	1,75	10	008610130
10	25	2,30	10	008610135

## 861TX

pontas para parafusos de perfil Torx®



ISO 1173 C 6,3

mm	L mm	€	10	200
T5	25	1,55	10	008610399
T6	25	1,55	10	008610400
T7	25	1,55	10	008610405
T8	25	1,55	10	008610410
T9	25	1,55	10	008610415
T10	25	1,20	10	008610420
T15	25	1,20	10	008610425
T20	25	1,20	10	008610430
T25	25	1,20	10	008610435
T27	25	1,20	10	008610440
T30	25	1,20	10	008610445
T40	25	1,20	10	008610450

## 861TX/C

pontas para parafusos de perfil Torx®

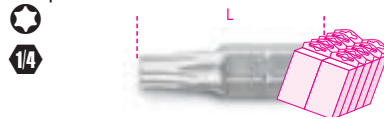

ISO 1173 C 6,3

mm	L mm	€	200	1000
T10	25	0,90	200	008610470
T15	25	0,90	200	008610475
T20	25	0,90	200	008610480

mm	L mm	€	200	1000
T25	25	0,90	200	008610485
T27	25	0,90	200	008610490
T30	25	0,90	200	008610495
T40	25	0,90	200	008610499

## 861RTX

pontas para parafusos de perfil Tamper Resistant Torx®



ISO 1173 C 6,3

mm	L mm	€	10	200
T7	25	2,25	10	008610538
T9	25	2,25	10	008610500
T10	25	2,25	10	008610505
T15	25	2,25	10	008610510
T20	25	2,25	10	008610515
T25	25	2,25	10	008610520
T27	25	2,25	10	008610525
T30	25	2,25	10	008610530
T40	25	2,25	10	008610535
T45	25	4,45	10	008610539

## 861RIBE

pontas para parafusos RIBE®



ISO 1173 C 6,3

mm	L mm	€	10	200
M5	25	1,00	10	008610705
M6	25	1,00	10	008610706
M7	25	1,20	10	008610707
M8	25	1,20	10	008610708
M9	25	1,75	10	008610709

## 861TRW

pontas para parafusos de perfil Tri-Wing®



ISO 1173 C 6,3

GR	L mm	€	10	200
1	25	1,90	10	008610601
2	25	1,90	10	008610602
3	25	1,90	10	008610603
4	25	1,90	10	008610604
5	25	1,90	10	008610605
6	25	2,75	10	008610606



## 861TQS

pontas para parafusos de perfil Torq-Set®



ISO 1173 C 6,3

GR	L mm	€	🔧	📦
0	25	1,90	10	008610620
1	25	1,90	10	008610621
2	25	1,90	10	008610622
3	25	1,90	10	008610623
4	25	1,90	10	008610624
5	25	1,90	10	008610625
6	25	1,90	10	008610626
8	25	1,90	10	008610628
10	25	1,90	10	008610630

## 861SP

pontas para parafusos de perfil Spanner

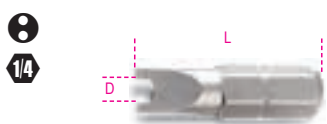

ISO 1173 C 6,3

SP	D mm	L mm	€	🔧	📦
4	1,5	25	1,55	10	008610650
6	2,4	25	1,55	10	008610653
8	2,8	25	1,55	10	008610656
10	3,3	25	1,55	10	008610658
12	3,9	25	1,55	10	008610660

## 1483KV-PT/S7



1483KV PT/S7

155

## 861XZN

pontas para parafusos XZN®



ISO 1173 C 6,3

Ø	L mm	€	🔧	📦
M5	25	1,00	10	008610725
M6	25	1,00	10	008610726
M8	25	1,20	10	008610728

## 861/C61P

61 pontas e 1 porta-pontas magnético de desengate rápido com punho



861/C61P 142,00 1 008610978

861LP	0,5x3 - 0,6x4,5 - 0,8x5,5 - 1,0x5,5 - 1,2x6,5 - 1,2x8 - 1,6x8 mm
861PE	2 - 2,5 - 3 - 4 - 5 - 6 - 8 - 10 mm
861PH	PH0 - PH1 - PH2 - PH3
861PZ	PZ1 - PZ2 - PZ3
861TX	T6 - T7 - T8 - T9 - T10 - T15 - T20 - T25 - T27 - T30 - T40
861RTX	T9 - T10 - T15 - T20 - T25 - T27 - T30 - T40
861TRW	1 - 2 - 3 - 4 - 5 - 6
861TQS	0 - 1 - 2 - 3 - 4 - 5 - 6 - 8 - 10
861SP	4 - 6 - 8 - 10 - 12
851SR	Ø 1/4"

270x120x45 mm - 975 g

## 862LP

pontas para parafusos de perfil de fenda



ISO 2351-1

ISO 1173 E 6,3

SxA mm	L mm	€	🔧	📦
0,5x3	50	3,20	5	008620005
0,6x4,5	50	3,20	5	008620010
0,8x5,5	50	3,20	5	008620015
1x5,5	50	3,20	5	008620020
1,2x6,5	50	3,20	5	008620025
1,2x8	50	3,95	5	008620030
1,6x8	50	3,95	5	008620035

## 862PH

pontas para parafusos de perfil Phillips®



ISO 2351-2

ISO 1173 E 6,3

PH	L mm	€	🔧	📦
1	50	3,20	5	008620200
2	50	3,20	5	008620205
3	50	3,20	5	008620210

## 862PH/L

pontas para parafusos de perfil Phillips®



ISO 2351-2

ISO 1173 E 6,3

PH	L mm	€	🔧	📦
1	70	5,85	5	008620230
2	70	5,85	5	008620232
3	70	5,85	5	008620234

## 862PH-XL

Pontas para parafusos de perfil Phillips®



ISO 2351-2ISO 1173 E 6,3

PH	L mm	€	🔧	📦
1	100	6,00	5	008620250
2	100	6,00	5	008620252
3	100	6,00	5	008620254

## 862PZ

pontas para parafusos de perfil Pozidriv® - Supadriv®



ISO 2351-2

ISO 1173 E 6,3

PZ	L mm	€	🔧	📦
1	50	3,30	5	008620300
2	50	3,30	5	008620305
3	50	3,30	5	008620310

## 862PE

pontas macho hexagonal



ISO 2351-3

ISO 1173 E 6,3

mm	L mm	€	🔧	📦
3	50	3,30	5	008620103
4	50	3,30	5	008620104
5	50	3,30	5	008620105
6	50	3,30	5	008620106
8	50	4,45	5	008620108



## 862TX

pontas para parafusos de perfil Torx®



ISO 1173 E 6,3

Ø	L mm	€	5	10
T9	50	4,35	5	008620509
T10	50	4,35	5	008620510
T15	50	4,35	5	008620515
T20	50	4,35	5	008620520
T25	50	4,35	5	008620525
T27	50	4,35	5	008620527
T30	50	4,35	5	008620530
T40	50	4,35	5	008620540

## 862TX/L

pontas para parafusos de perfil Torx®



ISO 1173 E 6,3

Ø	L mm	€	5	10
T9	70	4,75	5	008620559
T10	70	4,75	5	008620560
T15	70	4,75	5	008620565
T20	70	4,75	5	008620570
T25	70	4,75	5	008620575
T27	70	4,75	5	008620577
T30	70	4,75	5	008620580
T40	70	4,75	5	008620590

## 862TX-XL

Pontas para parafusos de perfil Torx®



ISO 1173 E 6,3

Ø	L mm	€	5	10
T9	100	5,15	5	008620659
T10	100	5,15	5	008620660
T15	100	5,15	5	008620665
T20	100	5,15	5	008620670
T25	100	5,15	5	008620675
T27	100	5,15	5	008620677
T30	100	5,15	5	008620680
T40	100	5,15	5	008620690

## 862F

pontas para chaves de caixa magnéticas



ISO 1173 E 6,3

mm	L mm	Ø mm	€	5	10
5,5	65	11	5,90	5	008620405
6	65	11	5,90	5	008620406
7	65	11	5,90	5	008620407
8	65	13	5,90	5	008620408
10	65	15	6,45	5	008620410
12	65	18	7,10	5	008620412
13	65	18	7,60	5	008620413

## 862F/A7

Jogo de 7 bits sextavados magnéticos com chaves de caixa sextavadas em estojo de plástico



862F/A7 € 45,00 1 008620950

862F 5,5-6-7-8-10-12-13 mm

## 866LP

pontas para parafusos de fendas



ISO 2351-1  
ISO 1173 C 8

SxA mm	L mm	€	5	10
1x5,5	41	3,30	10	008660005
1,2x6,5	41	3,30	10	008660010
1,6x8	41	3,30	10	008660015
1,6x10	41	4,40	10	008660020
2x12	41	5,45	10	008660025

## 866PH

pontas para parafusos de perfil Phillips®



ISO 2351-2

ISO 1173 C 8

PH	L mm	€	5	10
1	32	2,65	10	008660200
2	32	2,65	10	008660205
3	32	2,65	10	008660210
4	38	3,95	10	008660215

## 866PZ

pontas para parafusos de perfil Pozidriv® - Supadriv®



ISO 2351-2

ISO 1173 C 8

PZ	L mm	€	5	10
1	32	2,75	10	008660300
2	32	2,75	10	008660305
3	32	2,75	10	008660310
4	38	4,10	10	008660315

## 866PE

pontas macho hexagonal



ISO 2351-3

ISO 1173 C 8

mm	L mm	€	5	10
3	30	2,25	10	008660100
4	30	2,25	10	008660105
5	30	2,25	10	008660110
6	30	2,25	10	008660115
7	30	2,25	10	008660117
8	30	2,25	10	008660120
10	30	3,20	10	008660125
12	30	4,40	10	008660132
14	30	5,70	10	008660134

## 866TX

pontas para parafusos de perfil Torx®



ISO 1173 C 8

Ø	L mm	€	5	10
T20	30	2,85	10	008660400
T25	30	2,85	10	008660405
T27	30	2,85	10	008660410
T30	30	2,85	10	008660415
T40	30	2,85	10	008660420
T45	30	2,85	10	008660425
T50	30	2,85	10	008660430
T55	30	4,05	10	008660435
T60	30	5,45	10	008660440
T70	30	6,15	10	008660445

## 866RTX

pontas para parafusos de perfil Tamper Resistant Torx®



ISO 1173 C 8

Ø	L mm	€	5	10
T40	30	3,30	10	008660520
T45	30	3,30	10	008660525
T50	30	3,30	10	008660530
T55	30	4,60	10	008660535
T60	30	5,95	10	008660540
T70	30	7,35	10	008660545

Beta

## 867PE

pontas macho hexagonal



mm	L mm	€	🔧	📦
4	30	1,50	5	008670104
5	30	1,50	5	008670105
6	30	1,50	5	008670106
7	30	1,50	5	008670107
8	30	1,50	5	008670108
10	30	1,50	5	008670110
12	30	2,10	5	008670112

## 867PE/L

pontas hexagonais



mm	L mm	€	🔧	📦
4	75	2,65	5	008670154
5	75	2,65	5	008670155
6	75	2,65	5	008670156
7	75	2,65	5	008670157
8	75	2,65	5	008670158
10	75	2,65	5	008670160
12	75	3,75	5	008670162

## 867XZN

pontas para parafusos de perfil XZN®



Ø	L mm	€	🔧	📦
M4	30	1,75	5	008670204
M5	30	1,75	5	008670205
M6	30	1,75	5	008670206
M8	30	1,75	5	008670208
M10	30	1,75	5	008670210
M12	30	2,65	5	008670212

## 867XZN/L

pontas com perfil XZN®

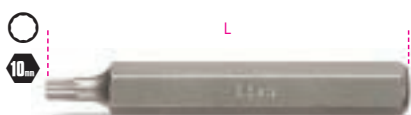

Ø	L mm	€	🔧	📦
M5	75	2,95	5	008670255
M6	75	2,95	5	008670256
M8	75	2,95	5	008670258
M10	75	2,95	5	008670260
M12	75	4,05	5	008670262

## 867TX

pontas para parafusos de perfil Torx®



Ø	L mm	€	🔧	📦
T20	30	1,50	5	008670400
T25	30	1,50	5	008670405
T30	30	1,50	5	008670410
T40	30	1,50	5	008670415
T45	30	1,50	5	008670420
T50	30	1,50	5	008670425
T55	30	1,50	5	008670430

## 867TX/L

pontas para parafusos de perfil Torx®



Ø	L mm	€	🔧	📦
T20	75	2,35	5	008670450
T25	75	2,35	5	008670455
T30	75	2,35	5	008670460
T40	75	2,35	5	008670465
T45	75	2,35	5	008670470
T50	75	2,35	5	008670475
T55	75	2,35	5	008670480

## 867RTX

pontas para parafusos de perfil Tamper Resistant Torx®



Ø	L mm	€	🔧	📦
T20	30	1,65	5	008670500
T25	30	1,65	5	008670505
T30	30	1,65	5	008670510
T40	30	1,65	5	008670515
T45	30	1,65	5	008670520
T50	30	1,65	5	008670525
T55	30	1,65	5	008670530

## 867RTX/L

pontas para parafusos de perfil Tamper Resistant Torx®



Ø	L mm	€	🔧	📦
T20	75	2,75	5	008670550
T25	75	2,75	5	008670555
T30	75	2,75	5	008670560
T40	75	2,75	5	008670565
T45	75	2,75	5	008670570
T50	75	2,75	5	008670575
T55	75	2,75	5	008670580

## 867RIBE

pontas para parafusos RIBE®

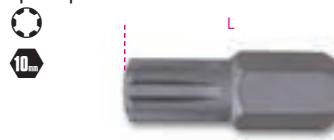

Ø	L mm	€	🔧	📦
M5	30	1,60	5	008670705
M6	30	1,60	5	008670706
M7	30	1,60	5	008670707
M8	30	1,60	5	008670708
M9	30	1,60	5	008670709
M10	30	1,60	5	008670710
M11	30	2,35	5	008670711
M12	30	2,35	5	008670712
M13	30	2,35	5	008670713

## 867RIBE/L

pontas para parafusos de perfil RIBE®



Ø	L mm	€	🔧	📦
M5	75	2,65	5	008670755
M6	75	2,65	5	008670756
M7	75	2,65	5	008670757
M8	75	2,65	5	008670758
M9	75	2,65	5	008670759
M10	75	2,65	5	008670760
M11	75	3,60	5	008670761
M12	75	3,60	5	008670762
M13	75	3,60	5	008670763

## 867/...

chaves de caixa porta-pontas para artigos 867



	Ø mm	L mm	Ø mm	€	🔧	📦
867/1	10	3/8"	38 17	5,15	5	008670600
867/2	10	1/2"	38 22	5,90	5	008670601

## 867/C20

jogo 18 bits para parafusos RIBE®, com encabadouro sextavado 10 mm e 2 acessórios



	€	🔧	📦
867/C20	101,00	1	008670920

	867RIBE	5-6-7-8-9-10-11-12-13 mm
	867RIBE/L	5-6-7-8-9-10-11-12-13 mm
	867/1	
	867/2	

📦 335x145x60 mm - 🏠 1,7 kg

## 867/C38

Porta Bits com punho em T articulado, 38 sextavados 10 mm



867/C38 € 183,00 1 008670938

852	10 mm
867PE	4-5-6-7-8-10-12mm
867PE/L	4-5-6-7-8-10-12mm
867XZN	M5-M6-M8-M10-M12
867XZN/L	M5-M6-M8-M10-M12
867TX	T20-T25-T30-T40-T45-T50-T55
867TX/L	T20-T25-T30-T40-T45-T50-T55

420x185x60 mm - 3 kg

## 867/C52

jogo com 52 pontas, com porta-pontas hexagonal de 10 mm e 2 acessórios

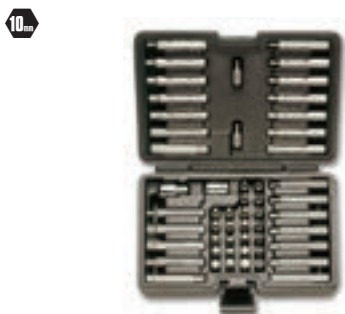

867/C52 € 118,00 1 008670901

867PE	4-5-6-7-8-10-12 mm
867PE/L	4-5-6-7-8-10-12 mm
867XZN	M5-M6-M8-M10-M12
867XZN/L	M5-M6-M8-M10-M12
867TX	T20-T25-T30-T40-T45-T50-T55
867TX/L	T20-T25-T30-T40-T45-T50-T55
867RTX	T20-T25-T30-T40-T45-T50-T55
867RTX/L	T20-T25-T30-T40-T45-T50-T55
867/1	○ 10 mm - □ 3/8"
867/2	○ 10 mm - □ 1/2"

250x170x70 mm - 2,1 kg

## 882

porta-pontas com anel de retenção para aparafusadoras



ISO 1173 E 6,3

L mm 57 1/4 1/4 11 € 14,70 5 008820001

## 882M1

porta-pontas magnético



ISO 1173 E 6,3

L mm 50 1/4 1/4 11 € 15,30 5 008820006

## 882M

porta-pontas magnético



ISO 1173 E 6,3

L mm 75 1/4 1/4 11 € 18,60 5 008820005

## 882MSR

porta-pontas magnético com desengate rápido para aparafusadoras



ISO 1173 E 6,3

L mm 50 75 1/4 1/4 11 € 16,40 19,10 5 008820205 5 008820207

## 882P

extensão para porta-bits magnético



L mm 80 1/4 1/4 10 € 13,60 5 008820080

## 892

adaptadores para aparafusadoras



	□	●	L mm	€		
892/0	1/4	1/4	25	4,80	5	008920000
* 892/1	1/4	5,5	50	8,95	5	008920001
* 892/2	3/8	5,5	50	13,60	5	008920002
* 892/3	1/4	1/4	50	8,95	5	008920003
° 892/4	3/8	1/4	50	13,70	5	008920004
892/5	1/4	5/16	75	12,60	5	008920005
892/6	3/8	5/16	75	18,60	5	008920006
892/7	1/2	1/4	75	19,10	5	008920007

\* ISO 1173 A 5,5  
° ISO 1173 C 6,3

## 895

chaves de caixa porta-pontas refª s. 861 - 862 - 866



DIN 7427

	○	□	L mm	Ø mm	€		
895/1	1/4	1/4	25,4	12	10,80	5	008950000
895/3	1/4	3/8	29	16,8	12,90	5	008950001
895/4	5/16	3/8	29	16,8	12,90	5	008950002
895/5	1/4	1/2	38	22	12,90	5	008950005
895/6	5/16	1/2	38	22	12,90	5	008950003

## 897

porta-pontas flexível com punho



L mm 280 L1 mm 154 € 24,20 2 008970010

## 897L

porta-pontas flexível com punho, modelo longo



L mm 500 L1 mm 380 € 28,50 2 008970015



## 900

chaves de caixa, boca hexagonal



UNI/ISO 2725 DIN 3124

Ø mm	L mm	Ø1 mm	€	🔧	📄
4	6,8	25	3,70	10	009000040
4,5	7,4	25	3,70	10	009000045
5	8,0	25	3,70	10	009000050
5,5	8,7	25	3,70	10	009000055
6	9,3	25	3,70	10	009000060
7	10,4	25	3,70	10	009000070
8	11,8	25	3,70	10	009000080
9	12,7	25	3,70	10	009000090
10	14,2	25	3,70	10	009000100
11	15,8	25	3,70	10	009000110
12	17,2	25	3,70	10	009000120
13	18,0	25	3,70	10	009000130
14	20,0	25	3,70	10	009000140



900/SB13	€	🔧	📄
4-4,5-5-5,5-6-7-8-9-10-11-12-13-14 mm	62,00	1	009000150

## 900MB

chaves de caixa boca de 12 faces



UNI/ISO 2725 DIN 3124

Ø mm	L mm	Ø1 mm	€	🔧	📄
4	6,7	22	7,10	5	009000160
5	7,7	25	7,10	5	009000161
5,5	8,3	25	7,10	5	009000162
6	9,0	25	7,10	5	009000163
7	10,2	25	7,10	5	009000164
8	11,3	25	7,10	5	009000165
9	13,0	25	7,10	5	009000166
10	14,3	25	7,10	5	009000167
11	16,0	25	7,10	5	009000168
12	17,4	25	7,10	5	009000169
13	18,0	25	7,95	5	009000170
14	19,3	25	8,35	5	009000171



900MB/SB12	€	🔧	📄
4-5-5,5-6-7-8-9-10-11-12-13-14 mm	100,50	1	009000179

## 900L

chaves de caixa série longa, boca hexagonal



UNI/ISO 2725 DIN 3124

Ø mm	L mm	Ø1 mm	€	🔧	📄
4	6,5	50	8,55	5	009000181
4,5	7,0	50	8,55	5	009000182
5	7,5	50	8,55	5	009000183
5,5	8,5	50	8,55	5	009000184
6	9,5	50	8,55	5	009000185
7	10,5	50	8,55	5	009000186
8	12,0	50	8,55	5	009000187
9	13,0	50	8,55	5	009000188
10	14,0	50	8,95	5	009000189
11	16,0	50	8,95	5	009000190
12	17,5	50	8,95	5	009000191
13	17,5	50	8,95	5	009000192
14	20,0	50	8,95	5	009000193



900L/SB13	€	🔧	📄
4-4,5-5-5,5-6-7-8-9-10-11-12-13-14 mm	127,00	1	009000203

## 900MB/L

chaves de caixa série longa, boca de 12 faces



UNI/ISO 2725 DIN 3124

Ø mm	L mm	Ø1 mm	€	🔧	📄
5	8,0	50	13,10	3	009000211
6	9,3	50	13,10	3	009000212
7	10,9	50	13,10	3	009000213
8	11,6	50	13,10	3	009000214
9	13,0	50	13,10	3	009000215
10	14,3	50	14,00	3	009000216
11	16,0	50	14,00	3	009000217
12	17,4	50	14,00	3	009000218
13	18,0	50	14,00	3	009000219
14	19,0	50	14,00	3	009000220

## 900AS

chaves de caixa boca hexagonal



Ø mm	L mm	Ø1 mm	€	🔧	📄
5/32	8,8	25	4,00	5	009000349
3/16	7,7	25	4,00	5	009000340
7/32	8,8	25	4,00	5	009000345
1/4	9,6	25	4,00	5	009000350
9/32	10,2	25	4,00	5	009000355
5/16	11,3	25	4,00	5	009000360
11/32	12,7	25	4,00	5	009000365

Ø mm	L mm	Ø1 mm	€	🔧	📄
3/8	14,0	25	4,00	5	009000370
7/16	15,3	25	4,00	5	009000375
1/2	17,5	25	4,00	5	009000380
9/16	19,0	25	4,00	5	009000385



900AS/SB11	€	🔧	📄
3/16-7/32-5/32-1/4-9/32-5/16-11/32-3/8-7/16-1/2-9/16	56,50	1	009000389

## 900AS/MB

chaves de caixa, boca de 12 faces



SAE AS 954E

Ø "	L mm	Ø1 mm	€	🔧	📄
3/16	7,7	22	7,20	2	009000390
7/32	8,5	22	7,20	2	009000391
1/4	9,4	22	7,20	2	009000392
9/32	10,2	22	7,20	2	009000393
5/16	11,3	22	7,20	2	009000394
11/32	12,5	22	7,20	2	009000395
3/8	13,7	22	7,75	2	009000396
7/16	15,6	22	7,75	2	009000397
1/2	17,2	22	8,40	2	009000398
9/16	18,8	24	8,40	2	009000399

## 900AS/L

chaves de caixa série longa, boca hexagonal



Ø "	L mm	Ø1 mm	€	🔧	📄
3/16	7,0	50	9,00	2	009000301
7/32	8,5	50	9,00	2	009000303
1/4	9,8	50	9,00	2	009000305
9/32	10,5	50	9,00	2	009000307
5/16	12,0	50	9,00	2	009000309
11/32	13,0	50	9,00	2	009000311
3/8	14,0	50	9,00	2	009000313
7/16	16,0	50	9,00	2	009000315
1/2	17,5	50	9,00	2	009000317
9/16	20,0	50	9,50	2	009000319

## 900AS/MBL

chaves de caixa série longa, boca de 12 faces



Ø "	L mm	Ø1 mm	€	🔧	📄
5/32	6,8	50	13,90	2	009000325
3/16	8,0	50	13,90	2	009000326
7/32	8,5	50	13,90	2	009000327
1/4	9,8	50	13,90	2	009000328
9/32	10,9	50	13,90	2	009000329

"	Ø mm	L mm	Ø1 mm	€		
5/16	11,6	50	12,0	13,90	2	009000330
11/32	13,0	50	12,0	13,90	2	009000331
3/8	14,3	50	12,8	15,10	2	009000332
7/16	16,0	50	14,2	15,10	2	009000333
1/2	18,0	50	16,2	15,10	2	009000334
9/16	19,0	50	17,1	15,10	2	009000335

## 900FTX

chaves de caixa para parafusos com cabeça Torx®

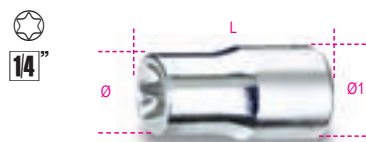

"	Ø mm	L mm	Ø1 mm	€		
E4	5,4	22	11,2	6,80	5	009000404
E5	6,7	22	11,2	6,80	5	009000405
E6	7,7	22	11,2	6,80	5	009000406
E7	8,3	22	11,2	6,80	5	009000407
E8	9,6	22	11,2	6,80	5	009000408
E10	11,3	22	12,0	6,80	5	009000410
E11	12,1	22	12,5	9,20	5	009000411
E12	12,9	23	12,9	9,20	5	009000412
E14	14,0	25	14,0	9,20	5	009000414



900FTX/SB9	€		
E4-E5-E6-E7-E8 E10-E11-E12-E14	79,50	1	009000419

## 900LP

chaves de caixa com ponta de perfil de fenda

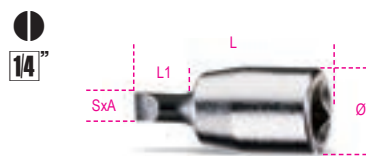

SxA mm	Ø mm	L mm	L1 mm	€		
0,8x4	12	28	9	8,30	5	009000605
1x5,5	12	28	9	8,30	5	009000610
1,2x6,5	12	28	9	8,30	5	009000615
1,2x8	13	28	8	8,30	5	009000620
1,6x10	14	28	8	8,30	5	009000625

## 900PH

chaves de caixa com ponta de perfil Phillips(R)



PH	Ø mm	L mm	L1 mm	€		
1	12	28	12	9,05	5	009000701
2	12	28	12	9,05	5	009000702
3	12	28	12	9,05	5	009000703
4	13	28	11	9,05	5	009000704

## 900ME

chaves de caixa com ponta macho hexagonal



mm	Ø mm	L mm	L1 mm	€		
2,5	12	25	4,5	7,80	5	009000502
3	12	25	5,0	7,80	5	009000503
4	12	25	5,6	7,80	5	009000504
5	12	25	6,3	7,80	5	009000505
6	12	25	7,6	7,80	5	009000506
7	13	25	7,2	7,80	5	009000507
8	13	25	8,0	7,80	5	009000508
10	13	25	8,7	9,60	5	009000510



900ME/SB8	€		
2,5-3-4-5-6-7-8-10 mm	74,50	1	009000518

## 900PT

chaves de caixa com pontas de 5 nervuras e furo central



PT	Ø mm	L mm	L1 mm	€		
PT10	12	28	12	16,40	5	009000750
PT15	12	28	12	16,40	5	009000755
PT20	12	28	12	16,40	5	009000760
PT25	12	28	12	16,40	5	009000765
PT27	12	28	12	16,40	5	009000767
PT30	12	28	12	16,40	5	009000770

## 900TX

chaves de caixa com ponta macho de perfil Torx(R)



T	Ø mm	L mm	L1 mm	€		
T8	12	28	12	12,30	5	009000719
T9	12	28	12	12,30	5	009000720
T10	12	28	12	12,30	5	009000721
T15	12	28	12	12,30	5	009000722
T20	12	28	12	12,30	5	009000723
T25	12	28	12	12,30	5	009000724
T27	12	28	12	12,30	5	009000725
T30	12	28	12	12,30	5	009000726
T40	12	28	12	12,30	5	009000727

900TX/SB8	€		
T9-T10-T15-T20 T25-T27-T30-T40	107,50	1	009000730

## 900/16

adaptador quadra fêmea de 1/4" para quadra macho de 3/8"



UNI/ISO 3316 DIN 3123

L mm	Ø mm	1/4"	3/8"	€		
28	13,0	1/4	3/8	6,25	5	009000814

## 900/...

extensões com quadras macho e fêmea de 1/4"

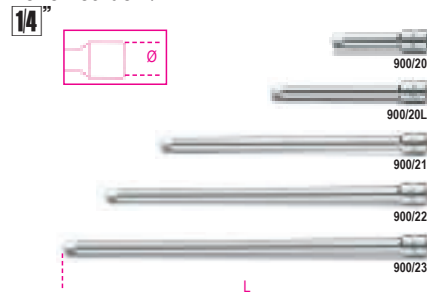

UNI/ISO 3316 DIN 3123

	L mm	Ø mm	€		
900/20	50	11,5	8,10	5	009000818
900/20L	100	11,5	8,30	5	009000819
900/21	150	11,5	8,65	5	009000822
900/22	250	11,5	12,70	5	009000823
900/23	350	11,5	15,30	5	009000824

## 900AN

extensões com quadras macho angulares e fêmea de 1/4"

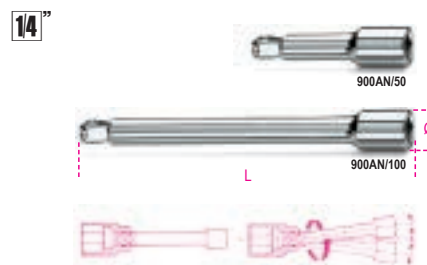

	L mm	Ø mm	€		
900AN/50	50	11,5	8,75	3	009000825
900AN/100	100	11,5	9,60	3	009000826



## 900FL

extensão flexível com quadras macho e fêmea de 1/4"

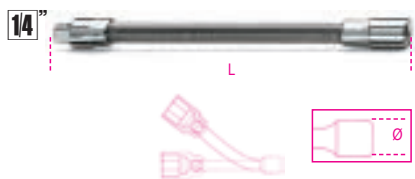

L mm	Ø mm	€	5	3	009000828
150	12	12,60			

## 900/25

cardan com quadras macho e fêmea de 1/4"



UNI/ISO 3316 DIN 3123

L mm	Ø mm	€	5	3	009000830
41	12,5	15,70			

## 900BG/30C

extensão 1/4" com punho, série curta



UNI/ISO 3315 DIN 3122

L mm	L1 mm	€	5	3	009000833
128	20	7,65			

## 900BG/30

extensão 1/4" com punho



UNI/ISO 3315 DIN 3122

L mm	L1 mm	€	5	3	009000834
176	68	8,00			

## 900/32

extensão flexível com punho quadra macho de 1/4"

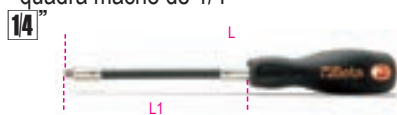

L mm	L1 mm	€	5	2	009000839
280	154	18,30			

## 900/35A

cabo articulado com punho quadra de 1/4"

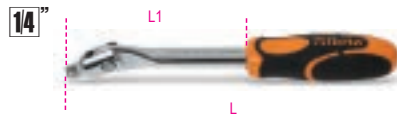

UNI/ISO 3315 DIN 3122

L mm	L1 mm	€	5	3	009000840
148	84	26,00			

## 900M/35

cabo articulado com punho metálico quadra de 1/4"



UNI/ISO 3315  
DIN 3122

L mm	€	5	3	009000845
130	34,00			

## 900/40

punho com cardan macho de 1/4"



L mm	L1 mm	€	5	3	009000843
390	145	35,00			

## 900/42

cabo T corrediço, quadra de 1/4"

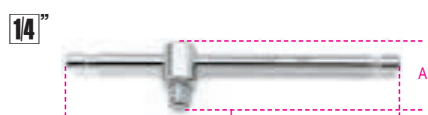

UNI/ISO 3315 DIN 3122

L mm	A mm	€	5	3	009000854
115	22	8,75			

## 900T/44

chave macho quadra 1/4" com punho



L mm	L1 mm	€	5	2	009000860
238	105	13,00			

## 900/55

roquete reversível quadra de 1/4" 48 dentes



UNI/ISO 3315 DIN 3122

L mm	Ø mm	A mm	€	5	009000870
125	25	18	42,00		

## 900M/55

roquete reversível com punho metálico quadra de 1/4"



UNI/ISO 3315  
DIN 3122

L mm	Ø mm	A mm	€	5	009000905
110	22	18	54,00		

Ver quadro depois do artigo 929/C8 para acessórios compatíveis usados

## 900/58

roquete reversível quadra de 1/4" com punho rotativo, 52 dentes

- Funcionamento através de punho rotativo
- Botão de desbloqueio da chave de caixa
- Sistema de inversão através de porca na cabeça do roquete
- Punho bi-material



L mm	Ø mm	A mm	€	5	009000884
126	28	28,5	64,00		

## 900/C39

jogo de 11 chaves de caixa sextavadas 21 bits e 7 acessórios

1/4"

1/4



900/C39 € 180,00 1 009000937

	861LP	0,6x4,5 - 1,2x6,5 - 1,2x8 mm
	861PH	PH1-PH2-PH3
	861PZ	PZ1-PZ2-PZ3
	861PE	2,5-3-4-5-6 mm
	861RTX	T10-T15-T20-T25-T27-T30-T40
	900	5-5,5-6-7-8-9-10-11-12-13-14 mm
	900/20	50 mm
	900/20L	100 mm
	900/25	
	900BG/30C	
	900/55	
	892/0	
	895/1	

## 900/C11

jogo com 11 chaves de caixa sextavadas, 20 pontas e 8 acessórios

1/4"

1/4



900/C11 € 198,00 1 009000971

	861LP	0,5x3 - 0,8x5,5 1x5,5 - 1,2x6,5 mm
	861PE	3 - 4 - 5 - 6 - 8 mm
	861PH	0 - 1 - 2 - 3
	861TX	T8 - T10 - T15 - T20 T25 - T30 - T40
	895/1	
	900	5 - 5,5 - 6 - 7 - 8 - 9 - 10 11 - 12 - 13 - 14 mm
	900/16	□ 1/4 - ■ 3/8
	900/20	50 mm
	900/21	150 mm
	900/25	
	900BG/30	
	900/42	
	900/55	

270x120x45 mm - 1,2 kg

## 900/C13-5

jogo com 13 chaves hexagonais e 5 acessórios

1/4"



900/C13-5 € 157,00 1 009000953

	900	4 - 4,5 - 5 - 5,5 - 6 - 7 - 8 - 9 10 - 11 - 12 - 13 - 14 mm
	900/21	150 mm
	900/25	
	900BG/30	
	900/42	
	900/55	

270x120x45 mm - 1 kg

## 900/C13-8

jogo com 13 chaves hexagonais e 8 acessórios

1/4"



900/C13-8 € 197,00 1 009000954

	900	4 - 4,5 - 5 - 5,5 - 6 - 7 - 8 - 9 10 - 11 - 12 - 13 - 14 mm
	900/16	□ 1/4 - ■ 3/8
	900/20	50 mm
	900/21	150 mm
	900/25	
	900BG/30	
	900/35A	
	900/42	
	900/55	

270x120x45 mm - 1,1 kg

## 900MB/C19

jogo com 11 chaves de caixa de 12 faces e 8 acessórios

1/4"



900MB/C19 € 229,00 1 009000977

	900MB	5 - 5,5 - 6 - 7 - 8 - 9 - 10 - 11 12 - 13 - 14 mm
	900/16	□ 1/4 - ■ 3/8
	900/20	50 mm
	900/21	150 mm
	900/25	
	900BG/30	
	900/35A	
	900/42	
	900/55	

270x120x45 mm - 1,1 kg

## 900/C24

jogo com 13 chaves de caixa hexagonais, 11 pontas e 6 acessórios

1/4"



900/C24 € 256,00 1 009000956

	900	4 - 4,5 - 5 - 5,5 - 6 - 7 - 8 - 9 10 - 11 - 12 - 13 - 14 mm
	900LP	0,8x4 - 1,2x6,5 - 1,2x8 mm
	900PH	PH1 - PH2 - PH3
	900ME	3 - 4 - 5 - 6 - 8 mm
	900/20	50 mm
	900/21	150 mm
	900/25	
	900BG/30	
	900/42	
	900/55	

270x120x45 mm - 1,1 kg

## 900MB/C28

jogo com 11 chaves de caixa de 12 faces, 11 pontas e 6 acessórios

14"



900MB/C28 € 288,00 1 009000979

	900MB	5-5,5-6-7-8-9-10-11 12-13-14 mm
	900LP	0,8x4 - 1,2x6,5 - 1,2x8 mm
	900PH	PH1 - PH2 - PH3
	900ME	3-4-5-6-8 mm
	900/20	50 mm
	900/21	150 mm
	900/25	
	900BG/30	
	900/42	
	900/55	

270x120x45 mm - 1,1 kg

## 900AS/C10 - /MB-C17

jogo com 10 chaves de caixa e 7 acessórios

14"



900AS/C10 € 183,00 1 009000961

	900AS	3/16 - 7/32 - 1/4 - 9/32 - 5/16 11/32 - 3/8 - 7/16 - 1/2 - 9/16
	900/20	50 mm
	900/21	150 mm
	900/25	
	900BG/30	
	900/35A	
	900/42	
	900/55	

270x120x45 mm - 1,1 kg

900AS/MB-C17 € 219,00 1 009000981

	900AS/MB	3/16 - 7/32 - 1/4 - 9/32 - 5/16 11/32 - 3/8 - 7/16 - 1/2 - 9/16
	900/20	50 mm
	900/21	150 mm
	900/25	
	900BG/30	
	900/35A	
	900/42	
	900/55	

270x120x45 mm - 1,1 kg

## 900AS/C17-MBM

jogo com 10 chaves de caixa com 12 faces e 7 acessórios

14"



900AS/C17-MBM € 239,00 1 009000982

	900AS/MB	3/16 - 7/32 - 1/4 - 9/32 - 5/16 11/32 - 3/8 - 7/16 - 1/2 - 9/16
	900/20	50 mm
	900/21	150 mm
	900/25	
	900BG/30	
	900M/35	
	900/42	
	900M/55	

270x120x45 mm - 1,2 kg

## 900/C11HR

11 chaves de caixa sextavadas, 20 bits e 7 acessórios, em estojo metálico com tabuleiro rígido

• roquete com punho rotativo

14"

14"



900/C11HR € 220,00 1 009000980

	861LP	0,5x3-0,8x5,5-1x5,5-1,2x6,5 mm
	861PH	PH0-PH1-PH2-PH3
	861PE	3-4-5-6-8 mm
	861TX	T8-T10-T15-T20-T25-T30-T40
	895/1	
	900	5-5,5-6-7-8-9-10-11-12-13-14 mm
	900/16	□ 1/4 - ■ 3/8
	900/20	50 mm
	900/21	150 mm
	900/25	
	900/42	
	900/30	
	900/58	

350x150x50 mm - 1,3 kg

## 902R/C6

jogo de 6 conversores de quadra para chaves de caixa



902R/C6 € 83,50 1 009020814

	900/16	□ 1/4 - ■ 3/8
	910/15	□ 3/8 - ■ 1/4
	910/16	□ 3/8 - ■ 1/2
	920/15	□ 1/2 - ■ 3/8
	920/16	□ 1/2 - ■ 3/4
	928/15	□ 3/4 - ■ 1/2

170x100x35 mm - 600 g

## 910A

chaves de caixa, boca hexagonal

3/8"

3/8"



UNI/ISO 2725 DIN 3124

Ø mm	Ø mm	L mm	Ø1 mm	€		
6	9,5	28	16,7	6,25	5	009100006
7	10,7	28	16,7	6,25	5	009100007
8	12,1	28	16,7	6,25	5	009100008
9	13,2	28	16,7	6,25	5	009100009
10	14,6	29	16,7	6,25	5	009100010
11	15,8	29	16,7	6,25	5	009100011
12	17,2	30	17,7	6,55	5	009100012
13	18,4	31	17,0	6,55	5	009100013
14	19,7	32	17,5	6,55	5	009100014
15	20,9	32	18,0	6,55	5	009100015
16	22,2	33	18,5	7,35	5	009100016
17	23,2	33	19,0	7,35	5	009100017
18	24,7	34	20,0	7,35	5	009100018
19	25,8	35	21,0	7,35	5	009100019
20	27,2	35	22,0	7,75	5	009100020
21	28,2	36	23,0	7,75	5	009100021
22	29,7	37	24,0	8,10	5	009100022

3/8"

3/8"



910A/SB17 € 135,00 1 009100030

6-7-8-9-10-11-12  
13-14-15-16-17  
18-19-20-21-22 mm

## 910B

chaves de caixa, boca de 12 faces

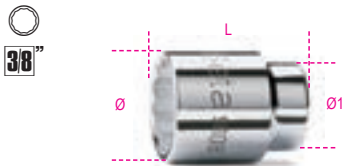

UNI/ISO 2725 DIN 3124

Ø	Ø	L	Ø1	€	U	PC
mm	mm	mm	mm			
6	9,5	28	16,7	6,25	5	009100106
7	10,7	28	16,7	6,25	5	009100107
8	12,1	28	16,7	6,25	5	009100108
9	13,2	28	16,7	6,25	5	009100109
10	14,6	29	16,7	6,25	5	009100110
11	15,8	29	16,7	6,25	5	009100111
12	17,2	30	17,7	6,55	5	009100112
13	18,4	31	17,0	6,55	5	009100113
14	19,7	32	17,5	6,55	5	009100114
15	20,9	32	18,0	6,55	5	009100115
16	22,2	33	18,5	7,35	5	009100116
17	23,2	33	19,0	7,35	5	009100117
18	24,7	34	20,0	7,35	5	009100118
19	25,8	35	21,0	7,35	5	009100119
20	27,2	35	22,0	7,75	5	009100120
21	28,2	36	23,0	7,75	5	009100121
22	29,7	37	24,0	8,10	5	009100122



910B/SB17	€	U	PC
6-7-8-9-10-11-12 13-14-15-16-17 18-19-20-21-22 mm	135,00	1	009100130

## 910AL

chaves de caixa série longa,  
boca hexagonal



UNI/ISO 2725 DIN 3124

Ø	Ø	L	Ø1	€	U	PC
mm	mm	mm	mm			
8	12,0	55	17	12,40	3	009100158
9	13,0	55	17	12,40	3	009100159
10	14,5	55	17	12,40	3	009100160
11	16,0	55	17	12,40	3	009100161
12	17,0	55	17	12,40	3	009100162
13	18,0	55	17	13,50	3	009100163
14	20,0	55	18	13,50	3	009100164
15	21,0	55	20	13,50	3	009100165
16	22,0	55	20	13,50	3	009100166
17	23,5	55	22	13,50	3	009100167
18	24,5	55	23	14,80	2	009100168
19	25,0	55	24	14,80	2	009100169
21	27,0	65	26	15,90	2	009100171
22	29,0	65	28	15,90	2	009100172



910AL/SB14	€	U	PC
8-9-10-11-12-13-14 15-16-17-18-19-21-22 mm	206,00	1	009100174

## 910BL

chaves de caixa série longa,  
boca de 12 faces



UNI/ISO 2725 DIN 3124

Ø	Ø	L	Ø1	€	U	PC
mm	mm	mm	mm			
8	12,0	55	17	12,40	3	009100308
9	13,0	55	17	12,40	3	009100309
10	14,5	55	17	12,40	3	009100310
11	16,0	55	17	12,40	3	009100311
12	17,0	55	17	12,40	3	009100312
13	18,0	55	17	13,50	3	009100313
14	20,0	55	18	13,50	3	009100314
15	21,0	55	20	13,50	3	009100315
16	22,0	55	20	13,50	3	009100316
17	23,5	55	22	13,50	3	009100317
18	24,5	55	23	14,80	2	009100318
19	25,0	55	24	14,80	2	009100319
21	27,0	65	26	15,90	2	009100321
22	29,0	65	28	15,90	2	009100322



910BL/SB14	€	U	PC
8-9-10-11-12-13 14-15-16-17-18 19-21-22 mm	206,00	1	009100340

## 910B/SN

chaves de caixa articuladas  
com boca de 12 faces

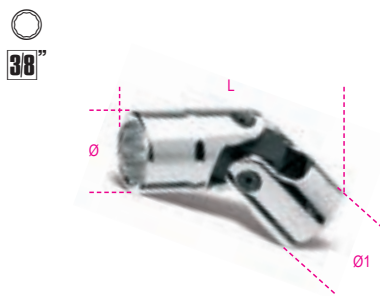

Ø	Ø	L	Ø1	€	U	PC
mm	mm	mm	mm			
10	14,5	48,5	19	32,00	2	009100230
11	15,8	49,5	19	32,00	2	009100231
12	17,0	50,0	19	32,00	2	009100232
13	18,3	51,0	19	32,00	2	009100233
14	19,5	51,0	19	35,50	2	009100234
15	20,8	53,5	19	35,50	2	009100235
16	22,0	53,5	19	35,50	2	009100236
17	23,3	54,5	19	35,50	2	009100237
18	24,5	54,5	19	35,50	2	009100238
19	25,8	56,5	19	35,50	2	009100239

Beta

## 910A/AS

chaves de caixa, boca hexagonal



Ø	Ø	L	Ø1	€	U	PC
mm	mm	mm	mm			
1/4	10,3	26	17,3	7,55	5	009100276
5/16	11,9	26	17,3	7,55	5	009100278
11/32	13,3	26	17,3	7,55	5	009100279
3/8	13,9	26	17,3	7,55	5	009100280
7/16	15,8	26	17,3	7,55	5	009100281
1/2	17,9	26	17,3	7,85	5	009100283
9/16	19,5	27	18,5	7,85	5	009100284
19/32	20,6	27	19,5	7,85	5	009100285
5/8	21,9	28	20,0	8,40	5	009100286
11/16	24,6	30	22,5	8,40	5	009100287
3/4	25,9	30	23,5	8,40	5	009100289
13/16	27,9	32	26,0	9,30	5	009100291
7/8	29,6	32	26,5	9,95	5	009100292



910A-AS/SB13	€	U	PC
1/4-5/16-11/32-3/8-7/16 1/2-9/16-19/32-5/8-11/16 3/4-13/16-7/8	121,00	1	009100295

## 910AS

chaves de caixa, boca de 12 faces

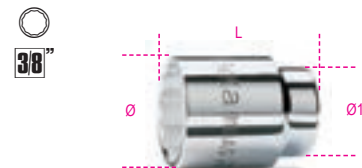

Ø	Ø	L	Ø1	€	U	PC
mm	mm	mm	mm			
1/4	9,5	28	16,7	7,55	5	009100201
5/16	12,1	28	16,7	7,55	5	009100202
11/32	13,2	28	16,7	7,55	5	009100203
3/8	14,6	29	16,7	7,55	5	009100204
7/16	15,8	29	16,7	7,55	5	009100205
1/2	18,4	31	17,0	7,85	5	009100206
9/16	19,7	32	17,5	7,85	5	009100207
19/32	20,9	32	18,0	7,85	5	009100208
5/8	22,2	33	18,5	8,40	5	009100209
11/16	24,7	34	20,0	8,40	5	009100210
3/4	25,8	35	21,0	8,40	5	009100211
13/16	28,2	36	23,0	9,30	5	009100212
7/8	29,7	37	24,0	9,95	5	009100213



910AS/SB13	€	U	PC
1/4-5/16-11/32-3/8-7/16 1/2-9/16-19/32-5/8-11/16 3/4-13/16-7/8	121,00	1	009100215

## 910AS/L

chaves de caixa série longa,  
boca de 12 faces

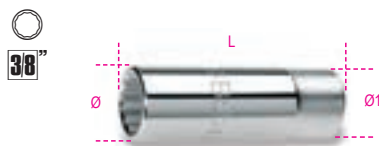

mm	Ø mm	L mm	Ø1 mm	€	Hand	Computer
1/4	10	55	17	15,30	3	009100350
5/16	12	55	17	15,30	3	009100351
3/8	14	55	17	15,30	3	009100352
7/16	16	55	17	15,30	3	009100353
1/2	18	55	17	16,90	3	009100354
9/16	20	55	18	16,90	3	009100355
19/32	21	55	20	17,50	3	009100356
5/8	22	55	20	17,50	3	009100357
11/16	23	55	22	17,50	3	009100359
3/4	25	55	24	18,60	3	009100360
13/16	27	65	26	21,80	3	009100362
7/8	29	65	28	21,80	3	009100363



910ASL/SB12	€	Hand	Computer
1/4-5/16-3/8-7/16 1/2-9/16-19/32-5/8-11/16 3/4-13/16-7/8	224,00	1	009100365

## 910AS/SN

chaves de caixa articuladas  
com boca de 12 faces



\* SAE AS 954E

mm	Ø mm	L mm	Ø1 mm	€	Hand	Computer
* 3/8	14,0	48,0	19	35,00	2	009100260
* 7/16	15,8	51,0	19	35,00	2	009100261
* 1/2	18,3	51,0	19	35,00	2	009100262
* 9/16	19,5	51,0	19	35,50	2	009100263
* 5/8	22,0	53,5	19	35,50	2	009100264
11/16	24,5	54,5	19	38,00	2	009100265
3/4	25,8	56,5	19	38,00	2	009100266

## 910FTX

chaves de caixa para parafusos  
de perfil Torx®

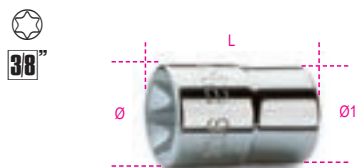

mm	Ø mm	L mm	Ø1 mm	€	Hand	Computer
E4	6,2	26	17,3	8,30	5	009100404
E5	7,0	26	17,3	8,30	5	009100405
E6	8,3	26	17,3	8,30	5	009100406
E7	8,9	26	17,3	8,30	5	009100407
E8	9,9	26	17,3	8,30	5	009100408
E10	12,0	26	17,3	8,30	5	009100410
E12	14,5	26	17,3	8,30	5	009100412
E14	15,8	26	17,3	8,30	5	009100414
E16	18,0	26	17,3	8,30	5	009100416



910FTX/SB9	€	Hand	Computer
E4-E5-E6-E7-E8 E10-E12-14-E16	86,00	1	009100430

## 910FTX/L

chaves de caixa série longa  
para parafusos de perfil Torx®



mm	Ø mm	L mm	Ø1 mm	€	Hand	Computer
E4	6,2	55	17,3	18,60	3	009100440
E5	7,0	55	17,3	18,60	3	009100441
E6	8,3	55	17,3	18,60	3	009100442
E7	8,9	55	17,3	18,60	3	009100443
E8	9,9	55	17,3	18,60	3	009100444
E10	12,0	55	17,3	18,60	3	009100445



910FTX-L/SB6	€	Hand	Computer
E4-E5-E6 E7-E8-E10	120,00	1	009100449

## 910LP

chaves de caixa com ponta  
de perfil de fenda



SxA mm	Ø mm	L mm	L1 mm	€	Hand	Computer
1x5,5	18,5	54	24	14,70	2	009100452
1,2x6,5	18,5	54	24	14,70	2	009100453
1,2x8	18,5	54	24	14,70	2	009100454
1,6x9	18,5	54	24	14,70	2	009100456

## 910PH

chaves de caixa com ponta  
de perfil Phillips®



PH	Ø mm	L mm	L1 mm	€	Hand	Computer
1	18,5	48	18	13,60	2	009100471
2	18,5	48	18	13,60	2	009100472
3	18,5	48	18	13,60	2	009100473
4	18,5	48	18	13,60	2	009100474

## 910PE

chaves de caixa com ponta  
macho hexagonal



DIN 7422

mm	Ø mm	L mm	L1 mm	€	Hand	Computer
3	18,5	50	20	11,70	5	009100490
4	18,5	50	20	11,70	5	009100492
5	18,5	50	20	11,70	5	009100494
6	18,5	50	20	11,70	5	009100496
7	18,5	50	20	11,70	5	009100497
8	18,5	50	20	11,70	5	009100498
10	18,5	50	20	11,70	5	009100500



910PE/SB7	€	Hand	Computer
3-4-5-6-7-8-10 mm	90,50	1	009100503

## 910BP

Chaves de caixa com ponta macho sextavada



mm	L mm	L1 mm	€	Hand	Computer
4L	92	62	14,10	3	009100584
5L	92	62	14,10	3	009100585
6L	92	62	14,10	3	009100586
7L	92	62	14,10	3	009100587
8L	92	62	14,10	3	009100588
10L	132	102	15,30	3	009100590

## 910ME

chaves de caixa com ponta  
macho hexagonal



mm	Ø mm	L mm	L1 mm	€	Hand	Computer
4	18	62	15	14,20	5	009100504
5	18	62	15	14,20	5	009100505
6	18	62	15	14,20	5	009100506
7	18	62	15	14,40	5	009100507
8	19	62	15	14,40	5	009100508
10	20	62	15	14,40	5	009100510
12	20	62	15	14,40	5	009100512



910ME/SB5	€	Hand	Computer
4-5-6-8-10 mm	78,50	1	009100515

## 910PT

chaves de caixa com pontas de 5 nervuras e furo central

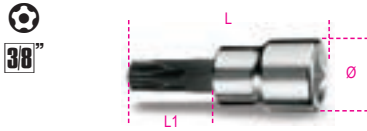

	Ø mm	L mm	L1 mm	€	U	IT
PT40	20	50	20	18,60	3	009100540
PT45	20	50	20	19,10	3	009100545
PT50	20	50	20	22,40	3	009100550



	€	U	IT
910PT/SB8 PT10-PT15-PT20-PT25 PT30-PT40-PT45-PT50	152,00	1	009100558

## 910TX

chaves de caixa com ponta macho de perfil Torx®



	Ø mm	L mm	L1 mm	€	U	IT
T15	18,5	50	20	15,70	5	009100519
T20	18,5	50	20	15,70	5	009100520
T25	18,5	50	20	15,70	5	009100521
T27	18,5	50	20	15,70	5	009100522
T30	18,5	50	20	15,70	5	009100523
T40	18,5	50	20	15,70	5	009100524



	€	U	IT
910TX/SB6 T15-T20-T25 T27-T30-T40	102,50	1	009100530

## 910CF

chaves pé de galo quadra fêmea de 3/8"



	A mm	L mm	€	U	IT
10	21,3	32,3	9,85	2	009100135
11	23,1	34,3	9,85	2	009100136
12	25,5	36,2	11,40	2	009100137
13	26,9	37,4	11,40	2	009100138
14	30,2	40,0	12,00	2	009100139
15	33,3	41,3	12,60	2	009100140
16	33,3	41,3	13,70	2	009100141
17	38,1	46,5	15,90	2	009100142
18	38,1	46,5	15,90	2	009100143
19	39,6	48,0	16,90	2	009100144



	€	U	IT
910CF/SB10 10-11-12-13-14-15 16-17-18-19 mm	142,00	1	009100147

## 910/15

redução quadra fêmea de 3/8"  
para quadra macho de 1/4"



UNI/ISO 3316 DIN 3123

L mm	Ø mm	□	■	€	U	IT
30	17,0	3/8	1/4	8,65	5	009100810



Aplique sempre uma força de aperto regular e progressiva, a fim de evitar a ruptura do material e de se proteger de um possível acidente

## 910/16

adaptador quadra fêmea de 3/8"  
para quadra macho de 1/2"



UNI/ISO 3316 DIN 3123

L mm	Ø mm	□	■	€	U	IT
32	18,0	3/8	1/2	9,05	5	009100814

## 910/20 - 910/21 - 910/22

extensões com quadras macho e fêmea de 3/8"

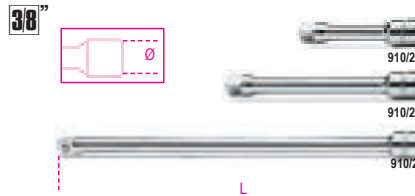

UNI/ISO 3316 DIN 3123

	L mm	Ø mm	€	U	IT
910/20	75	17	7,45	5	009100820
910/21	125	17	10,70	5	009100822
910/22	250	17	14,20	5	009100826

## 910AN

extensões com quadras macho angulares e fêmea de 3/8"

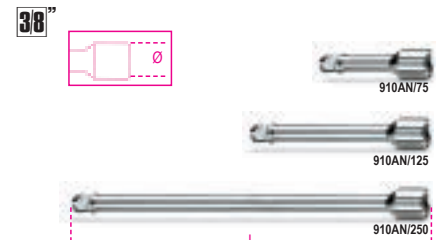

	L mm	Ø mm	€	U	IT
910AN/75	75	17	10,40	3	009100827
910AN/125	125	17	13,10	3	009100828
910AN/250	250	17	19,70	3	009100829

## 910/25

cardan com quadras macho e fêmea de 3/8"



UNI/ISO 3316 DIN 3123

L mm	Ø mm	€	U	IT
54,6	19	19,50	5	009100830

## 910M/35

cabo articulado com punho metálico, quadra de 3/8"



UNI/ISO 3315 DIN 3122

L mm	€	U	IT
250	53,50	3	009100839

## 910/36A

cabo articulado com punho quadra de 3/8"



UNI/ISO 3315 DIN 3122

L mm	L1 mm	€	U	IT
255	154	37,50	3	009100845

## 910/40

extensão articulada com punho em T quadra de 3/8"

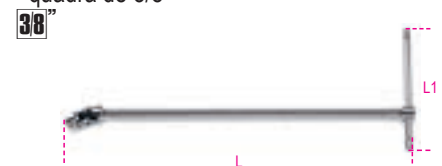

L mm	L1 mm	€	U	IT
420	175	40,50	3	009100850

**Beta**

## 910/42

cabo T corrediço, quadra de 3/8"

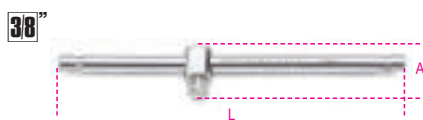

UNI/ISO 3315 DIN 3122

L	A	€	5	009100854
mm	mm			
210	30,5	12,60		

## 910/46

manivela quadra macho de 3/8"

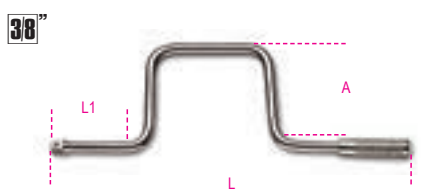

UNI/ISO 3315 DIN 3122

L	L1	A	€	1	009100862
mm	mm	mm			
315	80	115	25,00		

## 910/55

roquete reversível, quadra de 3/8"  
72 dentes



UNI/ISO 3315 DIN 3122

L	Ø	A	€	3	009100882
mm	mm	mm			
200	30	33	46,00		

## 910/55Q

roquete reversível, quadra de 3/8"  
48 dentes



UNI/ISO 3315 DIN 3122

L	Ø	A	€	3	009100885
mm	mm	mm			
200	30	33	46,00		

Ver quadro depois do artigo 929/C8  
para acessórios compatíveis usados

## 910M/55

roquete reversível com punho metálico  
quadra de 3/8"



L	Ø	A	€	2	009100875
mm	mm	mm			
178	30	26	63,50		

## 910M/56

roquete reversível articulado  
com punho metálico, quadra de 3/8"



L	Ø	A	€	2	009100887
mm	mm	mm			
265	31	29	85,50		

## 910/58

roquete reversível quadra 3/8"  
com punho rotativo,  
52 dentes

- Funcionamento através de punho rotativo
- Botão de desbloqueio da chave de caixa
- Sistema de inversão através de porca na cabeça do roquete
- Punho bi-material



L	Ø	A	€	1	009100884
mm	mm	mm			
222	37	38,5	70,00		

## 910.../C10

jogo com 10 chaves de caixa  
e 2 acessórios



910A/C10	148,00	1	009100909
----------	--------	---	-----------

- 910A 6 - 7 - 8 - 10 - 11 - 12  
13 - 14 - 17 - 19 mm
- 910/21 125 mm
- 910/55

270x120x45 mm - 1,3 kg

910B/C10	148,00	1	009100910
----------	--------	---	-----------

- 910B 6 - 7 - 8 - 10 - 11 - 12  
13 - 14 - 17 - 19 mm
- 910/21 125 mm
- 910/55

270x120x45 mm - 1,3 kg

## 910A/C16...

jogo com 16 chaves de caixa de 12 faces  
e 5 acessórios



910A/C16	243,00	1	009100936
----------	--------	---	-----------

- 910A 6 - 7 - 8 - 9 - 10 - 11 - 12 - 13  
14 - 15 - 16 - 17 - 18 - 19  
21 - 22 mm
- 910/21 125 mm
- 910/22 250 mm
- 910/25
- 910/42
- 910/55

335x145x60 mm - 2,3 kg

910A/C16Q	243,00	1	009100932
-----------	--------	---	-----------

- 910A 6 - 7 - 8 - 9 - 10 - 11 - 12 - 13  
14 - 15 - 16 - 17 - 18 - 19  
21 - 22 mm
- 910/21 125 mm
- 910/22 250 mm
- 910/25
- 910/42
- 910/55Q

335x145x60 mm - 2,3 kg

# Beta

## 910B/C16...

jogo com 16 chaves de caixa de 12 faces e 5 acessórios

38"



910B/C16 € 243,00 1 009100937

- 910B 6 - 7 - 8 - 9 - 10 - 11 - 12 - 13  
14 - 15 - 16 - 17 - 18 - 19  
21 - 22 mm
  - 910/21 125 mm
  - 910/22 250 mm
  - 910/25
  - 910/42
  - 910/55
- ≡ 335x145x60 mm - 2,3 kg

910B/C16Q € 243,00 1 009100933

- 910B 6 - 7 - 8 - 9 - 10 - 11 - 12 - 13  
14 - 15 - 16 - 17 - 18 - 19  
21 - 22 mm
  - 910/21 125 mm
  - 910/22 250 mm
  - 910/25
  - 910/42
  - 910/55Q
- ≡ 335x145x60 mm - 2,3 kg

## 910A/C17

jogo com 17 chaves de caixa hexagonais e 9 acessórios

38"



910A/C17 € 358,00 1 009100938

- 910A 6 - 7 - 8 - 9 - 10 - 11 - 12 - 13  
14 - 15 - 16 - 17 - 18 - 19 - 20  
21 - 22 mm
  - 910/15 □ 3/8 - ■ 1/4
  - 910/16 □ 3/8 - ■ 1/2
  - 910/21 125 mm
  - 910/22 250 mm
  - 910/25
  - 910/36A
  - 910/42
  - 910/46
  - 910/55
- ≡ 420x280x60 mm - 4,0 kg

## 910.../C29

jogo com 17 chaves de caixa, 12 pontas e 5 acessórios

38"



910A/C29 € 410,00 1 009100944

- 910A 6 - 7 - 8 - 9 - 10 - 11 - 12 - 13  
14 - 15 - 16 - 17 - 18 - 19 - 20  
21 - 22 mm
  - 910LP 1x5,5 - 1,2x6,5 - 1,2x8 mm
  - ⊕ 910PH PH1 - PH2 - PH3
  - 910PE 3 - 4 - 5 - 6 - 8 - 10 mm
  - 910/21 125 mm
  - 910/22 250 mm
  - 910/25
  - 910/42
  - 910/55
- ≡ 420x185x60 mm - 3,5 kg

910B/C29 € 410,00 1 009100945

- 910B 6 - 7 - 8 - 9 - 10 - 11 - 12 - 13  
14 - 15 - 16 - 17 - 18 - 19 - 20  
21 - 22 mm
  - 910LP 1x5,5 - 1,2x6,5 - 1,2x8 mm
  - ⊕ 910PH PH1 - PH2 - PH3
  - 910PE 3 - 4 - 5 - 6 - 8 - 10 mm
  - 910/21 125 mm
  - 910/22 250 mm
  - 910/25
  - 910/42
  - 910/55
- ≡ 420x185x60 mm - 3,5 kg

## 910AS/C13...

jogo com 13 chaves de caixa de 12 faces e 5 acessórios

38"



910AS/C13 € 240,00 1 009100925

- 910AS 1/4 - 5/16 - 11/32 - 3/8 - 7/16  
1/2 - 9/16 - 19/32 - 5/8 - 11/16  
3/4 - 13/16 - 7/8
  - 910/21 125 mm
  - 910/22 250 mm
  - 910/42
  - 910/25
  - 910/55
- ≡ 335x145x60 mm - 2,3 kg

## 910AS/MBM-C18

jogo com 13 chaves de caixa de 12 faces e 5 acessórios

38"



910AS/MBM-C18 € 258,00 1 009100926

- 910AS 1/4 - 5/16 - 11/32 - 3/8 - 7/16  
1/2 - 9/16 - 19/32 - 5/8 - 11/16  
3/4 - 13/16 - 7/8
  - 910/21 125 mm
  - 910/22 250 mm
  - 910/25
  - 910/42
  - 910M/55
- ≡ 335x145x60 mm - 2,5 kg

## 910A/C16HR

Jogo de 16 chaves de caixa sextavadas e 5 acessórios em módulo soft e caixa metálica

• roquete com punho rotativo

38"



910A/C16HR € 267,00 1 009100935

- 910A 6 - 7 - 8 - 9 - 10 - 11 - 12 - 13  
14 - 15 - 16 - 17 - 18 - 19  
21 - 22 mm
  - 910/21 125 mm
  - 910/22 250 mm
  - 910/25
  - 910/42
  - 910/58
- ≡ 335x145x60 mm - 2,4 kg

 **Beta**



## 920A

chaves de caixa boca hexagonal

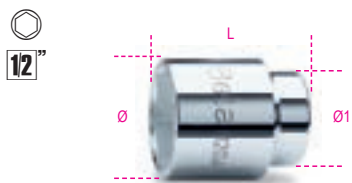

UNI/ISO 2725 DIN 3124

mm	Ø	L	Ø1	€	μ	box
8	12,4	38	21,7	5,05	10	009200008
9	13,5	38	21,7	5,05	10	009200009
10	14,9	38	21,7	5,05	10	009200010
11	16,1	38	21,7	5,05	10	009200011
12	17,5	38	21,7	5,05	10	009200012
13	18,7	38	21,7	5,50	10	009200013
14	20,1	38	21,7	5,50	10	009200014
15	21,5	38	22,5	5,50	10	009200015
16	22,7	38	23,7	5,85	10	009200016
17	24,1	38	23,1	5,85	10	009200017
18	25,3	39	24,0	5,85	10	009200018
19	26,6	39	24,0	5,85	10	009200019
20	27,8	40	25,0	6,75	5	009200020
21	28,8	40	25,0	6,75	5	009200021
22	29,9	41	26,0	6,75	5	009200022
23	30,8	42	26,0	7,35	5	009200023
24	32,2	43	27,0	7,35	5	009200024
25	33,2	44	27,0	7,35	5	009200025
26	34,7	45	28,0	7,70	5	009200026
27	36,2	46	29,0	7,70	5	009200027
28	37,2	47	30,0	7,70	5	009200028
29	38,6	48	31,0	8,30	5	009200029
30	40,2	48	32,0	8,30	5	009200030
32	42,3	49	33,9	8,55	5	009200032



**920A/SB13** 87,50 1 009200040  
10-11-12-13-14-15-16  
17-18-19-20-21-22 mm



**920A/SB8** 70,50 1 009200042  
23-24-25-26-27-28-30-32 mm

## 920B

chaves de caixa, boca de 12 faces

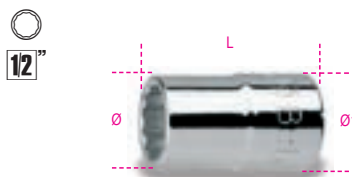

UNI/ISO 2725 DIN 3124

mm	Ø	L	Ø1	€	μ	box
8	12,4	38	21,7	5,05	10	009200108
9	13,5	38	21,7	5,05	10	009200109
10	14,9	38	21,7	5,05	10	009200110
11	16,1	38	21,7	5,05	10	009200111
12	17,5	38	21,7	5,05	10	009200112
13	18,7	38	21,7	5,50	10	009200113
14	20,1	38	21,7	5,50	10	009200114
15	21,5	38	22,5	5,50	10	009200115
16	22,7	38	23,7	5,85	10	009200116
17	24,1	38	23,1	5,85	10	009200117

mm	Ø	L	Ø1	€	μ	box
18	25,3	39	24,0	5,85	10	009200118
19	26,6	39	24,0	5,85	10	009200119
20	27,8	40	25,0	6,75	5	009200120
21	28,8	40	25,0	6,75	5	009200121
22	29,9	41	26,0	6,75	5	009200122
23	30,8	42	26,0	7,35	5	009200123
24	32,2	43	27,0	7,35	5	009200124
25	33,2	44	27,0	7,35	5	009200125
26	34,7	45	28,0	7,70	5	009200126
27	36,2	46	29,0	7,70	5	009200127
28	37,2	47	30,0	7,70	5	009200128
29	38,6	48	31,0	8,30	5	009200129
30	40,2	48	32,0	8,30	5	009200130
32	42,3	49	33,9	8,55	5	009200132



**920B/SB13** 87,50 1 009200140  
10-11-12-13-14-15-16  
17-18-19-20-21-22 mm



**920B/SB8** 70,50 1 009200142  
23-24-25-26-27  
28-30-32 mm

## 920AL

chaves de caixa série longa, boca hexagonal



UNI/ISO 2725 DIN 3124

mm	Ø	L	Ø1	€	μ	box
10	14,7	77	21	16,20	5	009200626
12	17,8	77	21	16,20	5	009200627
13	19,0	77	22	16,20	5	009200628
14	20,3	77	22	16,20	5	009200629
15	21,5	77	22	16,20	5	009200630
16	22,8	77	22	16,90	5	009200631
17	24,0	77	23	16,90	5	009200632
18	25,0	77	24	18,30	5	009200633
19	26,5	77	25	18,30	5	009200634
21	29,0	77	27	20,20	5	009200635
22	30,0	77	28	20,20	5	009200636
23	31,5	77	29	20,20	5	009200637
24	32,8	77	30	22,90	5	009200638
27	36,5	77	33	24,00	3	009200639
30	40,0	77	36	29,00	3	009200640
32	42,8	77	38	29,50	3	009200641
36	48,0	77	41	48,00	3	009200642



**920AL/SB11** 205,00 1 009200644  
10-12-13-14-15-16  
17-18-19-21-22 mm

## 920BL

chaves de caixa série longa, boca de 12 faces

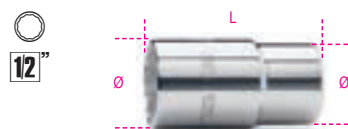

UNI/ISO 2725 DIN 3124

mm	Ø	L	Ø1	€	μ	box
10	14,7	77	21	16,20	5	009200310
12	17,8	77	21	16,20	5	009200312
13	19,0	77	22	16,20	5	009200313
14	20,3	77	22	16,20	5	009200314
15	21,5	77	22	16,20	5	009200315
16	22,8	77	22	16,90	5	009200316
17	24,0	77	23	16,90	5	009200317
18	25,0	77	24	18,30	5	009200318
19	26,5	77	25	18,30	5	009200319
21	29,0	77	27	20,20	5	009200321
22	30,0	77	28	20,20	5	009200322
23	31,5	77	29	20,20	5	009200323
24	32,8	77	30	22,90	5	009200324
27	36,5	77	33	24,00	3	009200327
30	40,0	77	36	29,00	3	009200330
32	42,8	77	38	29,50	3	009200332
36	48,0	77	41	48,00	3	009200336



**920BL/SB11** 205,00 1 009200338  
10-12-13-14-15-16-17-18  
19-21-22 mm

## 920A/AS

chaves de caixa boca hexagonal

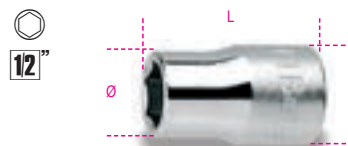

"	mm	L	Ø1	€	μ	box
3/8	14,6	37	21	5,70	2	009200270
7/16	16,5	37	21	5,70	3	009200272
1/2	19,0	37	22	6,15	3	009200273
9/16	20,3	37	22	6,15	3	009200274
19/32	21,0	37	22	6,70	3	009200275
5/8	22,8	37	22	6,70	3	009200276
11/16	25,0	37	24	6,80	3	009200277
3/4	26,5	38	25	6,80	3	009200279
25/32	28,0	38	26	7,75	3	009200280
13/16	29,0	38	27	7,75	3	009200281
7/8	30,0	40	28	7,75	3	009200282
15/16	32,8	42	30	8,40	3	009200284
1	35,0	42	32	8,40	3	009200285
1.1/16	36,5	43	33	8,95	2	009200287
1.1/8	39,0	43	35	9,20	2	009200289
1.3/16	41,0	46	36	9,85	2	009200290
1.1/4	42,8	46	38	9,90	2	009200292



**920A-AS/SB11** 87,00 1 009200295  
3/8-7/16-1/2-9/16-5/8  
11/16-3/4-13/16-7/8  
15/16-1

## 920AS

chaves de caixa, boca de 12 faces

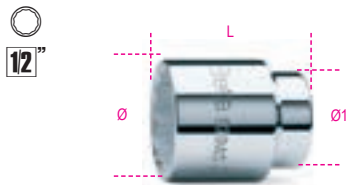

"	Ø mm	L mm	Ø1 mm	€		
3/8	14,9	38	21,7	5,70	3	009200201
7/16	16,1	38	21,7	5,70	3	009200202
1/2	18,7	38	21,7	6,15	3	009200203
9/16	20,1	38	21,7	6,15	3	009200204
5/8	22,7	38	22,5	6,70	3	009200206
19/32	21,5	38	23,7	6,70	3	009200207
11/16	25,3	39	24,0	6,80	3	009200208
3/4	26,6	39	24,0	6,80	3	009200209
25/32	27,8	40	25,0	7,75	3	009200210
13/16	28,8	40	25,0	7,75	3	009200211
7/8	29,9	41	26,0	7,75	3	009200212
15/16	32,2	43	27,0	8,40	3	009200214
1	34,2	45	28,0	8,40	3	009200216
1.1/16	36,2	46	29,0	8,95	2	009200217
1.1/8	38,6	48	31,0	9,20	2	009200218
1.3/16	40,2	48	32,0	9,85	2	009200219
1.1/4	42,3	49	33,5	9,90	2	009200220



920AS/SB11	€		
3/8-7/16-1/2-9/16-5/8 11/16-3/4-13/16-7/8 15/16-1	87,00	1	009200225

## 920AS/L

chaves de caixa série longa  
boca hexagonal



"	Ø mm	L mm	Ø1 mm	€		
1/2	19,0	77	22	22,10	2	009200352
9/16	20,3	77	22	22,10	2	009200353
5/8	22,8	77	22	22,10	2	009200355
11/16	25,0	77	24	23,50	2	009200357
3/4	26,5	77	25	24,00	2	009200358
13/16	29,0	77	27	28,00	2	009200360
7/8	30,0	77	28	28,00	2	009200361
15/16	32,8	77	30	29,00	2	009200362
1	35,0	77	32	30,00	2	009200363
1.1/16	36,5	77	33,0	33,00	2	009200364
1.1/8	37,8	77	34	34,00	2	009200365



920ASL/SB11	€		
1/2-9/16-5/8-11/16 3/4-13/16-7/8-15/16 1-1.1/8-1.1/16	308,00	1	009200369

## 920FTX

chaves de caixa para parafusos  
de perfil Torx®

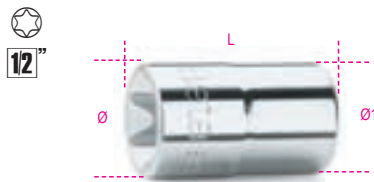

"	Ø mm	L mm	Ø1 mm	€		
E10	13,2	36	21	9,60	5	009200380
E12	15,0	37	21	9,60	5	009200381
E14	16,3	37	21	9,60	5	009200382
E16	18,8	37	22	9,60	5	009200383
E18	20,4	37	22	9,60	5	009200384
E20	22,9	37	22	10,40	5	009200385
E22	25,0	37	24	12,00	3	009200387
E24	26,5	40	25	13,70	3	009200388



920FTX/SB6	€		
E10-E12-E14 E16-E18-E20	66,50	1	009200390



920FTX/C8	€		
E10-E12-E14-E16 E18-E20-E22-E24	111,00	1	009200391

≡ 270X120X45 mm - 1 kg

## 920FTX/L

chaves de caixa série longa  
para parafusos de perfil Torx®



"	Ø mm	L mm	Ø1 mm	€		
E10	13,2	77	21,0	20,20	5	009200400
E12	15,0	77	21,0	20,20	5	009200401
E14	16,3	77	21,0	20,20	5	009200402
E16	18,8	77	21,8	20,20	3	009200403
E18	20,4	77	21,8	20,20	3	009200404
E20	22,9	77	22,0	20,20	3	009200405



920FTX-LSB6	€		
E10-E12-E14 E16-E18-E20	130,00	1	009200409

## 920LP

chaves de caixa com ponta  
de perfil de fenda



SxA mm	Ø mm	L mm	L1 mm	€		
1x5,5	22,5	62	24	15,90	3	009200452
1,2x6,5	22,5	62	24	15,90	3	009200453
1,2x8	22,5	62	24	15,90	3	009200454
1,6x9	22,5	62	24	15,90	3	009200456
2x12	22,5	62	24	15,90	3	009200458

## 920PH

chaves de caixa com ponta  
de perfil Phillips®



PH	Ø mm	L mm	L1 mm	€		
1	22,5	56	18	13,80	3	009200471
2	22,5	56	18	13,80	3	009200472
3	22,5	56	18	13,80	3	009200473
4	22,5	56	18	13,80	3	009200474

## 920LH/SB7

chaves de caixa com ponta  
de perfil Phillips®



920LH/SB7	€		
920LP 920PH	114,00	1	009200478

## 920PE

chaves de caixa com ponta macho hexagonal

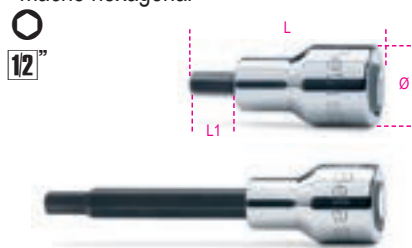

DIN 7422

mm	Ø mm	L mm	L1 mm	€	🔧	📦
3	22,5	58	20	12,60	5	009200410
4	22,5	58	20	12,60	5	009200412
5	22,5	58	20	12,60	5	009200414
5L	22,5	100	62	13,80	5	009200415
6	22,5	58	20	12,60	5	009200417
6L	22,5	100	62	13,80	5	009200418
7	22,5	58	20	12,60	5	009200420
7L	22,5	100	62	13,80	5	009200421
8	22,5	58	20	12,60	5	009200423
8L	22,5	100	62	13,80	5	009200424
9	22,5	58	20	12,60	5	009200425
9L	22,5	140	102	14,20	5	009200426
10	22,5	58	20	12,60	5	009200428
10L	22,5	140	102	14,20	5	009200429
12	23,0	58	20	14,80	5	009200432
12L	22,5	140	102	16,40	5	009200433
14	23,0	58	20	14,80	5	009200434
14L	22,5	140	102	16,40	5	009200435
17	29,5	60	22	18,00	5	009200437
19	29,5	60	22	18,00	5	009200439



**920PE/SB9** 129,00 € 1 009200441  
4-5-6-8-10 mm  
5L-6L-8L-10L mm



**920PE/C10** 167,00 € 1 009200443  
4-5-6-7-8-10  
12-14-17-19 mm  
270X120X45 mm - 1,5 kg

## 920PE/AS

chaves de caixa com ponta macho hexagonal



"	Ø mm	L mm	L1 mm	€	🔧	📦
1/8	22,5	58	20	14,70	2	009200460
3/16	22,5	58	20	14,70	2	009200461
1/4	22,5	58	20	14,70	2	009200463
3/8	22,5	58	20	14,70	2	009200464
1/2	22,5	60	20	15,90	2	009200465
3/4	22,5	60	20	16,90	1	009200468

## 920BP

chaves de caixa com ponta macho hexagonal esférico

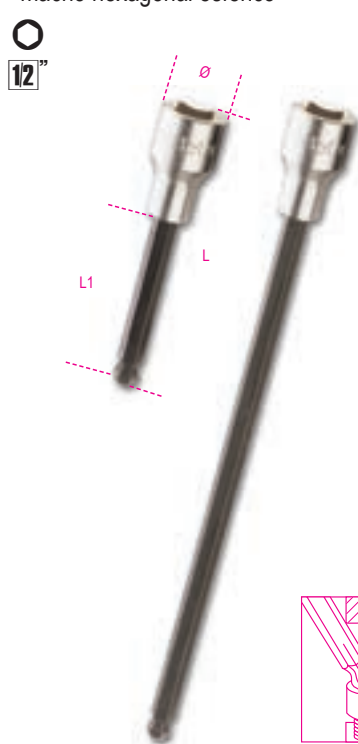

mm	Ø mm	L mm	L1 mm	€	🔧	📦
5L	22,5	100	62	15,90	5	009200490
5XL	22,5	240	202	20,20	1	009200495
6L	22,5	100	62	15,90	5	009200491
6XL	22,5	240	202	20,20	1	009200496
7L	22,5	100	62	15,90	5	009200492
8L	22,5	100	62	15,90	5	009200493
8XL	22,5	240	202	20,20	1	009200497
10L	22,5	140	102	16,90	5	009200494



**920BP/SB8** 151,00 € 1 009200500  
5L-6L-7L-8L-10L mm  
5XL-6XL-8XL mm

## 920ME

chaves de caixa com ponta macho hexagonal

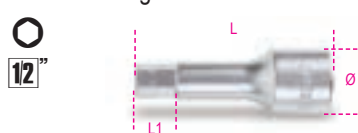

mm	Ø mm	L mm	L1 mm	€	🔧	📦
5	21	75	15,5	14,80	5	009200505
6	21	75	15,5	14,80	5	009200506
7	21	75	15,5	14,80	5	009200507
8	21	75	15,5	14,80	5	009200508
10	23	75	15,5	15,30	5	009200510
12	24	75	15,5	17,50	5	009200512
14	24	75	15,5	17,50	5	009200514
17	24	75	15,5	17,50	5	009200517



**920ME/SB7** 121,00 € 1 009200519  
5-6-8-10-12-14-17 mm



**920ME/C7** 137,00 € 1 009200518  
5-6-8-10-12-14-17 mm  
250X100X35 mm - 1,4 kg

## 920TX

chaves de caixa com ponta macho de perfil Torx®



mm	Ø mm	L mm	L1 mm	€	🔧	📦
T20	22,5	58	20	15,50	5	009200520
T20L	22,5	120	82	19,90	3	009200530
T25	22,5	58	20	15,50	5	009200521
T25L	22,5	120	82	19,90	3	009200531
T27	22,5	58	20	15,50	5	009200522
T27L	22,5	120	82	19,90	3	009200533
T30	22,5	58	20	15,50	5	009200523
T30L	22,5	120	82	19,90	3	009200534
T40	22,5	58	20	15,50	5	009200524
T40L	22,5	120	82	19,90	3	009200535
T45	22,5	58	20	15,50	5	009200525
T45L	22,5	120	82	19,90	3	009200537
T50	22,5	58	20	15,50	5	009200526
T50L	23,0	140	102	19,90	3	009200538
T55	23,0	58	20	20,80	3	009200527
T55L	23,0	140	102	28,00	3	009200539
T60	23,0	58	20	20,80	3	009200528
T60L	23,0	140	102	28,00	3	009200540
T70L	23,0	120	82	28,00	3	009200541



**920TX-SB9** 161,00 € 1 009200532  
T20-T25-T27-T30  
T40-T45-T50-T55-T60



**920TX-L/SB10** 235,00 € 1 009200545  
T20L-T25L-T27L-T30L-T40L-  
T45L-T50L-T55L-T60L-T70L



**920TX/C9** € 177,00 1 009200546

T20-T25-T27-T30-T40  
T45-T50-T55-T60

270X120X45 mm - 1,2 kg

## 920RTX

chaves de caixa com ponta macho de perfil Tamper Resistant Torx®



	Ø mm	L mm	L1 mm	€		
T20	22,5	58	20	16,40	5	009200370
T25	22,5	58	20	16,40	5	009200371
T27	22,5	58	20	16,40	5	009200372
T30	22,5	58	20	16,40	5	009200373
T40	22,5	58	20	16,40	5	009200374



**920RTX/SB5** € 89,00 1 009200378

T20-T25-T27-T30-T40

## 920XZN

chaves de caixa com ponta macho de perfil XZN(R)

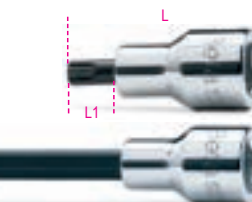

DIN 2324

	Ø mm	L mm	L1 mm	€		
M4	22,5	58	20	16,40	3	009200559
M5	22,5	58	20	16,40	3	009200560
M6	22,5	58	20	16,40	3	009200561
M6L	22,5	100	62	18,70	3	009200562
M8	22,5	58	20	16,40	3	009200563
M8L	22,5	100	62	18,70	3	009200564
M9	22,5	58	20	16,40	3	009200582
M9L	22,5	100	62	18,70	3	009200583
M10	22,5	58	20	16,40	3	009200565
M10L	22,5	100	62	18,70	3	009200566
M12	22,5	58	20	16,90	3	009200568
M12L	22,5	100	62	19,10	3	009200569
M14	23,0	58	20	16,90	3	009200571
M14L	23,0	100	62	19,10	3	009200572
M16	23,0	58	20	21,30	3	009200573
M18	23,0	58	20	21,80	3	009200574



**920XZN/SB7** € 125,00 1 009200579

M4-M5-M6-M8  
M10-M12-M14



**920XZN/SB12** € 229,00 1 009200577

M5-M6-M8-M10-M12  
M14-M16-M6L-M8L  
M10L-M12L-M14L



**920XZN-L/S5** € 94,50 1 009200578

M6L-M8L-M10L  
M12L-M14L

## 920ES

chaves de caixa com pontas de 6 caneluras



UNI 9326

Ø mm		L mm	L1 mm	€		
7	(6R)	58	20	22,40	5	009200587
7XL	(6R)	240	202	32,50	1	009200607
9	(8R)	58	20	22,40	5	009200589
9XL	(8R)	240	202	32,50	1	009200609
10	(8S)	58	20	22,40	5	009200590
10XL	(8S)	240	202	32,50	1	009200610
11	(10R)	58	20	22,40	5	009200591
11XL	(10R)	240	202	32,50	1	009200611
12L	(10S)	100	62	25,00	3	009200592
12XL	(10S)	240	202	35,00	1	009200612
14L	(12S)	100	62	25,00	3	009200594
14XL	(12S)	240	202	35,00	1	009200614
16L	(14R)	100	62	25,00	3	009200596
16XL	(14R)	240	202	35,00	1	009200616



**920ES/SB7** € 174,00 1 009200598

7-9-10-11-12L-14L-16L



**920ES-XL/SB7** € 243,00 1 009200618

7XL-9XL-10XL-11XL  
12XL-14XL-16XL

## 920/15

redução quadra fêmea de 1/2" para quadra macho de 3/8"



UNI/ISO 3316 DIN 3123

L mm	□	■	Ø mm	€		
42	1/2	3/8	22,0	9,85	5	009200810



Aplique sempre uma força de aperto regular e progressiva, a fim de evitar a ruptura do material e de se proteger de um possível acidente

## 920/16

adaptador quadra fêmea de 1/2" para quadra macho de 3/4"



UNI/ISO 3316 DIN 3123

L mm	□	■	Ø mm	€		
46	1/2	3/4	26	12,60	5	009200814

## 920/20÷920/23

extensões com quadras macho e fêmea de 1/2"



UNI/ISO 3316 DIN 3123

	L mm	Ø mm	€		
920/20	75	22	12,00	5	009200818
920/21	125	22	14,80	5	009200822
920/22	255	22	16,40	5	009200826
920/23	375	22	21,80	2	009200827

## 920AN

extensões com quadras macho angulares e fêmea de 1/2"

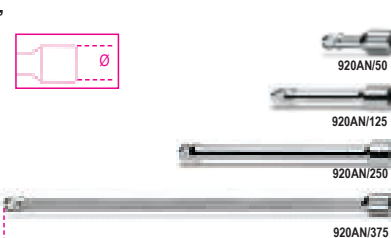

	L mm	Ø mm	€		
920AN/50	50	22	12,60	5	009200833
920AN/125	125	22	17,50	5	009200834
920AN/250	250	22	25,00	3	009200835
920AN/375	375	22	34,00	3	009200836



## 920/25

cardan com quadras macho e fêmea de 1/2"



UNI/ISO 3316 DIN 3123

L	Ø	€	🔧	📦
mm	mm			
75	27	23,30	5	009200830

## 920/35A

cabos articulados com punho quadra de 1/2"



UNI/ISO 3315 DIN 3122

L	L1	€	🔧	📦
mm	mm			
285	160	46,50	3	009200846

## 920M/35

cabo articulado com punho metálico quadra de 1/2"



UNI/ISO 3315 DIN 3122

L	€	🔧	📦
mm			
380	66,50	2	009200845

## 920M/35L

punho articulado quadra macho 1/2" com cabo metálico, série longa



L	€	🔧	📦
mm			
600	101,50	1	009200843



Aplique sempre uma força de aperto regular e progressiva, a fim de evitar a ruptura do material e de se proteger de um possível acidente

## 920/36A

cabo articulado com punho quadra de 1/2"

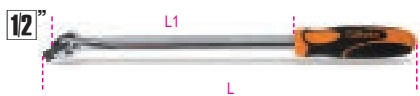

UNI/ISO 3315 DIN 3122

L	L1	€	🔧	📦
mm	mm			
408	283	52,00	2	009200847

## 920/38

cabo articulado extensível com punho, quadra 1/2"



L	L max	€	🔧	📦
mm	mm			
262	402	78,50	1	009200839

## 920/40

extensão articulada com punho em T quadra de 1/2"

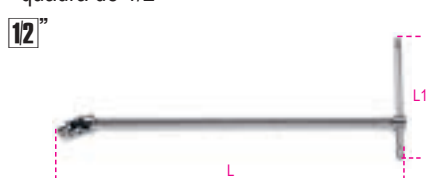

L	L1	€	🔧	📦
mm	mm			
490	230	53,50	2	009200850

## 920/42

cabo T corrediço, quadra de 1/2"

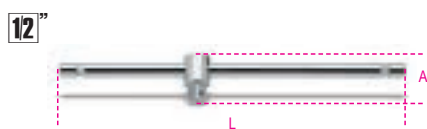

L	A	€	🔧	📦
mm	mm			
305	42	16,40	5	009200854

## 920/44

cabo angular quadra de 1/2"



L	L1	€	🔧	📦
mm	mm			
230	60	24,00	3	009200858

## 920/46

manivela quadra macho de 1/2"

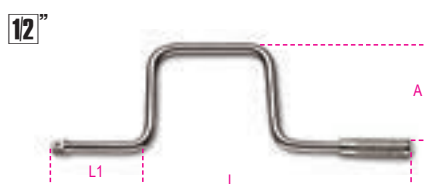

L	L1	A	€	🔧	📦
mm	mm	mm			
385	110	160	29,50	1	009200862

## 920/50

roquete simples quadra de 1/2" 72 dentes



UNI/ISO 3315 DIN 3122

L	Ø	A	€	🔧	📦
mm	mm	mm			
275	40	42	52,00	3	009200871

## 920/50F

roquete simples quadra fêmea de 1/2" 72 dentes



UNI/ISO 3315 DIN 3122

L	Ø	A	€	🔧	📦
mm	mm	mm			
275	40	27	48,00	2	009200889

## 920/55

roquete reversível com quadra de 1/2" 72 dentes



UNI/ISO 3315 DIN 3122

L	Ø	A	€	🔧	📦
mm	mm	mm			
275	40	43	55,50	3	009200882

## 920/55Q

roquete reversível com quadra de 1/2" 48 dentes



UNI/ISO 3315 DIN 3122

L	Ø	A	€	🔧	📦
mm	mm	mm			
275	40	43	55,50	3	009200885

## 920/55X

roquete reversível com quadra de 1/2"  
72 dentes



UNI/ISO 3315 DIN 3122

L	Ø	A	€	📦	📄
mm	mm	mm			
200	30	33	47,00	3	009200895

## 920/55LC

roquete reversível com quadra de 1/2"  
"Locking System" de 72 dentes



UNI/ISO 3315 DIN 3122

L	Ø	A	€	📦	📄
mm	mm	mm			
275	40	43	64,00	2	009200896

## 920/55L

roquete reversível extensível,  
quadra macho 1/2",  
72 dentes



L	L max	Ø	A	€	📦	📄
mm	mm	mm	mm			
282	422	40	43	96,00	1	009200927

## 920M/55

roquete reversível com punho metálico  
quadra de 1/2"

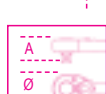

L	Ø	A	€	📦	📄
mm	mm	mm			
253	38	35	72,00	1	009200893

## 920/56A

roquete reversível articulado  
quadra de 1/2" de 72 dentes



L	Ø	A	€	📦	📄
mm	mm	mm			
315	40	43	89,50	1	009200911

## 920M/56

roquete reversível articulado  
com punho metálico, quadra de 1/2"



L	Ø	A	€	📦	📄
mm	mm	mm			
330	38	35,7	95,00	2	009200894

## 920/58

roquete reversível quadra 1/2"  
com punho rotativo,  
52 dentes

- Funcionamento através de punho rotativo
- Botão de desbloqueio da chave de caixa
- Sistema de inversão através de porca na cabeça do roquete
- Punho bi-material



L	Ø	A	€	📦	📄
mm	mm	mm			
281	42,5	45	82,50	1	009200926

Ver quadro depois do artigo 929/C8  
para acessórios compatíveis usados

## 920.../C11

jogo com 11 chaves de caixa  
e 2 acessórios

12"



920A/C11	€	📦	📄
	177,00	1	009200921

	920A	10 - 12 - 13 - 14 - 15 - 16 17 - 18 - 19 - 21 - 22 mm
	920/22	255 mm
	920/50	
	335x145x60 mm	2,5 kg

920B/C11	€	📦	📄
	177,00	1	009200922

	920B	10 - 12 - 13 - 14 - 15 - 16 17 - 18 - 19 - 21 - 22 mm
	920/22	255 mm
	920/50	
	335x145x60 mm	2,5 kg

## 920.../C12...

jogo com 12 chaves de caixa  
e 5 acessórios

12"



920A/C12X	€	📦	📄
	256,00	1	009200933

	920A	10 - 11 - 12 - 13 - 14 - 17 - 19 22 - 24 - 27 - 30 - 32 mm
	920/21	125 mm
	920/22	255 mm
	920/25	
	920/42	
	920/55	
	420x185x60 mm	4,2 kg

920A/C12	€	📦	📄
	252,00	1	009200931

	920A	10 - 11 - 12 - 13 - 14 - 17 - 19 22 - 24 - 27 - 30 - 32 mm
	920/21	125 mm
	920/22	255 mm
	920/25	
	920/42	
	920/50	
	420x185x60 mm	4,2 kg

920B/C12X € 256,00 1 009200934

- 920B 10 - 11 - 12 - 13 - 14 - 17 - 19  
22 - 24 - 27 - 30 - 32 mm
  - 920/21 125 mm
  - 920/22 255 mm
  - 920/25
  - 920/42
  - 920/55
- 420x185x60 mm - 4,0 kg

920B/C12 € 252,00 1 009200932

- 920B 10 - 11 - 12 - 13 - 14 - 17 - 19  
22 - 24 - 27 - 30 - 32 mm
  - 920/21 125 mm
  - 920/22 255 mm
  - 920/25
  - 920/42
  - 920/50
- 420x185x60 mm - 4,0 kg

### 920.../C20...

jogo com 20 chaves de caixa e 5 acessórios

12"



920A/C20X € 321,00 1 009200950

- 920A 10 - 11 - 12 - 13 - 14 - 15 - 16  
17 - 18 - 19 - 20 - 21 - 22 - 23  
24 - 26 - 27 - 28 - 30 - 32 mm
  - 920/21 125 mm
  - 920/22 255 mm
  - 920/25
  - 920/42
  - 920/55
- 420x185x60 mm - 5,1 kg

920A/C20 € 318,00 1 009200948

- 920A 10 - 11 - 12 - 13 - 14 - 15 - 16  
17 - 18 - 19 - 20 - 21 - 22 - 23  
24 - 26 - 27 - 28 - 30 - 32 mm
  - 920/21 125 mm
  - 920/22 255 mm
  - 920/25
  - 920/42
  - 920/50
- 420x185x60 mm - 5,1 kg

920A/C20Q € 321,00 1 009200955

- 920A 10 - 11 - 12 - 13 - 14 - 15 - 16  
17 - 18 - 19 - 20 - 21 - 22 - 23  
24 - 26 - 27 - 28 - 30 - 32 mm
  - 920/21 125 mm
  - 920/22 255 mm
  - 920/25
  - 920/42
  - 920/55Q
- 420x185x60 mm - 5,1 kg

920B/C20 € 318,00 1 009200949

- 920B 10 - 11 - 12 - 13 - 14 - 15 - 16  
17 - 18 - 19 - 20 - 21 - 22 - 23  
24 - 26 - 27 - 28 - 30 - 32 mm
  - 920/21 125 mm
  - 920/22 255 mm
  - 920/25
  - 920/42
  - 920/50
- 420x185x60 mm - 5,0 kg

920B/C20X € 321,00 1 009200951

- 920B 10 - 11 - 12 - 13 - 14 - 15 - 16  
17 - 18 - 19 - 20 - 21 - 22 - 23  
24 - 26 - 27 - 28 - 30 - 32 mm
  - 920/21 125 mm
  - 920/22 255 mm
  - 920/25
  - 920/42
  - 920/55
- 420x185x60 mm - 5,0 kg

### 920.../C21...

jogo com 21 chaves de caixa e 6 acessórios

12"



920A/C21 € 367,00 1 009200952

- 920A 10 - 11 - 12 - 13 - 14 - 15 - 16  
17 - 18 - 19 - 20 - 21 - 22 - 23  
24 - 25 - 26 - 27 - 28 - 30 - 32 mm
  - 920/21 125 mm
  - 920/22 255 mm
  - 920/25
  - 920/42
  - 920/46
  - 920/50
- 420x280x60 mm - 6,5 kg

920A/C21X € 370,00 1 009200983

- 920A 10 - 11 - 12 - 13 - 14 - 15 - 16  
17 - 18 - 19 - 20 - 21 - 22 - 23  
24 - 25 - 26 - 27 - 28 - 30 - 32 mm
  - 920/21 125 mm
  - 920/22 255 mm
  - 920/25
  - 920/42
  - 920/46
  - 920/55
- 420x280x60 mm - 6,4 kg

920B/C21 € 367,00 1 009200953

- 920B 10 - 11 - 12 - 13 - 14 - 15 - 16  
17 - 18 - 19 - 20 - 21 - 22 - 23  
24 - 25 - 26 - 27 - 28 - 30 - 32 mm
  - 920/21 125 mm
  - 920/22 255 mm
  - 920/25
  - 920/42
  - 920/46
  - 920/50
- 420x280x60 mm - 6,4 kg

920B/C21X € 370,00 1 009200984

- 920B 10 - 11 - 12 - 13 - 14 - 15 - 16  
17 - 18 - 19 - 20 - 21 - 22 - 23  
24 - 25 - 26 - 27 - 28 - 30 - 32 mm
  - 920/21 125 mm
  - 920/22 255 mm
  - 920/25
  - 920/42
  - 920/46
  - 920/55
- 420x280x60 mm - 6,4 kg



## 920B/C30Q

jogo com 30 chaves de caixa de 12 faces e 5 acessórios

12"



920B/C30Q € 512,00 1 009200986

- 920B 10 - 11 - 12 - 13 - 14 - 15 - 16  
17 - 18 - 19 - 20 - 21 - 22 - 23  
24 - 26 - 27 - 28 - 30 - 32 mm
  - 920LP 1,2x8 - 1,6x9 - 2x12 mm
  - 920PH PH2 - PH3 - PH4
  - 920PE 4 - 5 - 6 - 8 - 10 - 12 - 14 mm
  - 920/21 125 mm
  - 920/22 255 mm
  - 920/25
  - 920/42
  - 920/55
- 420x280x60 mm - 6,7 kg

## 920.../C33

jogo com 20 chaves de caixa, 13 pontas e 5 acessórios

12"



920A/C33 € 512,00 1 009200985

- 920A 10 - 11 - 12 - 13 - 14 - 15 - 16  
17 - 18 - 19 - 20 - 21 - 22 - 23  
24 - 26 - 27 - 28 - 30 - 32 mm
  - 920LP 1,2x8 - 1,6x9 - 2x12 mm
  - 920PH PH2 - PH3 - PH4
  - 920PE 4 - 5 - 6 - 8 - 10 - 12 - 14 mm
  - 920/21 125 mm
  - 920/22 255 mm
  - 920/25
  - 920/42
  - 920/55
- 420x280x60 mm - 6,7 kg

920B/C33 € 512,00 1 009200986

- 920B 10 - 11 - 12 - 13 - 14 - 15 - 16  
17 - 18 - 19 - 20 - 21 - 22 - 23  
24 - 26 - 27 - 28 - 30 - 32 mm
- 920LP 1,2x8 - 1,6x9 - 2x12 mm
- 920PH PH2 - PH3 - PH4
- 920PE 4 - 5 - 6 - 8 - 10 - 12 - 14 mm
- 920/21 125 mm
- 920/22 255 mm
- 920/25
- 920/42
- 920/55

420x280x60 mm - 6,7 kg

## 920/C37

jogo com 37 chaves de caixa de 12 faces e 2 acessórios

12"



920/C37 € 487,00 1 009200988

- 920B 10 - 11 - 12 - 13 - 14 - 15 - 16  
17 - 18 - 19 - 20 - 21 - 22 - 23  
24 - 26 - 27 - 28 - 30 - 32 mm
- 920AS 3/8 - 7/16 - 1/2 - 9/16 - 19/32  
5/8 - 11/16 - 3/4 - 25/32 - 13/16  
7/8 - 15/16 - 1 - 1.1/16 - 1.1/8  
1.3/16 - 1.1/4
- 920/21 125 mm
- 920/22 255 mm
- 920/25
- 920/42
- 920/55

420x280x60 mm - 7,5 kg

## 920AS/C10

jogo com 10 chaves de caixa de 12 faces e 2 acessórios

12"



920AS/C10 € 182,00 1 009200919

- 920AS 3/8 - 7/16 - 1/2 - 9/16 - 5/8  
11/16 - 3/4 - 13/16 - 7/8 - 15/16
- 920/22 255 mm
- 920/50

335x145x60 mm - 2,6 kg

## 920AS/C15

jogo com 15 chaves de caixa de 12 faces e 6 acessórios

12"



920AS/C15 € 338,00 1 009200947

- 920AS 3/8 - 7/16 - 1/2 - 9/16 - 5/8 - 11/16  
3/4 - 13/16 - 7/8 - 15/16 - 1  
1.1/16 - 1.1/8 - 1.3/16 - 1.1/4
- 920/21 125 mm
- 920/22 255 mm
- 920/25
- 920/42
- 920/46
- 920/50

420x280x60 mm - 5,9 kg



## 920AS/C17X

jogo com 17 chaves de caixa de 12 faces e 5 acessórios

12"



920AS/C17X € 319,00 1 009200942

	○ 920AS	3/8 - 7/16 - 1/2 - 9/16 - 19/32 - 5/8 11/16 - 3/4 - 25/32 - 13/16 - 7/8 15/16 - 1 - 1.1/16 - 1.1/8 - 1.3/16 - 1.1/4
	920/21	125 mm
	920/22	255 mm
	920/25	
	920/42	
	⊕ 920/55	

420x185x60 mm - 4,8 kg

## 920TX/C17

jogo com 6 pontas, 6 chaves de caixa, 5 chaves de caixa com ponta e 4 acessórios, para parafusos de perfil Torx®



12"



920TX/C17 € 288,00 1 009200989

	⊕ 861TX	T8 - T10 - T15 - T20 - T25 - T27
	897	
	⊕ 920TX	T27 - T30 - T40 - T45 - T50
	⊕ 920FTX	E10 - E12 - E14 - E16 - E18 - E20
	920/20	75 mm
	920/22	255 mm
	⊕ 920/55	

420x185x60 mm - 2,9 kg

## 928A

chaves de caixa com boca hexagonal



3/4"



UNI/ISO 2725  
DIN 3124

Ø	Ø	L	Ø1	€	5	10
mm	mm	mm	mm			
19	29,2	50	34	15,00	5	009280019
22	31,3	53	34	15,20	5	009280022
23	33,3	53	34	15,40	5	009280023
24	34,5	53	34	15,60	5	009280024
26	36,8	55	35	16,80	5	009280026
27	38,0	56	35	16,80	5	009280027
28	39,0	57	35	17,60	3	009280028
29	40,2	58	35	17,90	3	009280029
30	41,5	58	37	18,10	3	009280030
32	44,3	60	37	19,10	3	009280032
33	45,8	60	37	20,20	3	009280033
34	46,8	60	37	20,20	3	009280034
35	48,1	62	38	21,00	3	009280035
36	49,5	64	38	21,00	3	009280036
38	52,0	68	40	22,90	3	009280038
41	56,0	71	40	25,50	3	009280041
46	62,3	75	43	32,00	3	009280046
50	67,4	80	43	38,50	3	009280050
55	73,7	84	48	48,00	1	009280055
60	80,0	87	48	54,50	1	009280060

## 920AS/MBM-C21

jogo com 16 chaves de caixa de 12 faces e 5 acessórios

12"



920AS/MBM-C21 € 324,00 1 009200944

	○ 920AS	3/8 - 7/16 - 1/2 - 9/16 19/32 - 5/8 - 11/16 - 3/4 25/32 - 13/16 - 7/8 - 15/16 1 - 1.1/16 - 1.3/16 - 1.1/4
	920M/55	
	920/21	125 mm
	920/22	255 mm
	920/25	
	920/42	

420x185x60 mm - 5,0 kg

## 920A/C17HR

17 chaves de caixa sextavadas e 5 acessórios em estojo metálico com tabuleiro rígido

• roquete com punho rotativo

12"



920A/C17HR € 320,00 1 009200939

	○ 920A	10-11-12-13-14-15-16-17-18-19-20- 21-22-24-27-30-32 mm
	920/21	125 mm
	920/22	255 mm
	920/25	
	920/42	
	920/58	

420x185x60 mm - 5,1 kg

## 928B

chaves de caixa boca de 12 faces



3/4"



UNI/ISO 2725  
DIN 3124

Ø	Ø	L	Ø1	€	5	10
mm	mm	mm	mm			
19	29,2	50	34	15,00	5	009280119
22	31,3	53	34	15,20	5	009280122
23	33,3	53	34	15,40	5	009280123
24	34,5	53	34	15,60	5	009280124
26	36,8	55	35	16,80	5	009280126
27	38,0	56	35	16,80	5	009280127
28	39,0	57	35	17,60	3	009280128
29	40,2	58	35	17,90	3	009280129
30	41,5	58	37	18,10	3	009280130
32	44,3	60	37	19,10	3	009280132
33	45,8	60	37	20,20	3	009280133
34	46,8	60	37	20,20	3	009280134
35	48,1	62	38	21,00	3	009280135
36	49,5	64	38	21,00	3	009280136
38	52,0	68	40	22,90	3	009280138
41	56,0	71	40	25,50	3	009280141
46	62,3	75	43	32,00	3	009280146
50	67,4	80	43	38,50	3	009280150
55	73,7	84	48	48,00	1	009280155
60	80,0	87	48	54,50	1	009280160

## 928AS

chaves de caixa boca hexagonal

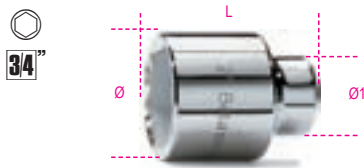

mm	Ø	L	Ø1	€	U	W
mm	mm	mm	mm			
7/8	32,0	53	34	16,90	1	009280202
15/16	34,5	53	34	16,90	1	009280203
1	36,2	55	35	18,00	1	009280204
1.1/16	38,0	56	35	18,60	1	009280205
1.1/8	40,2	58	35	19,10	1	009280206
1.1/4	44,2	60	37	20,80	1	009280208
1.5/16	45,8	60	37	21,30	1	009280209
1.3/8	48,1	62	38	22,40	1	009280210
1.7/16	49,5	64	38	23,50	1	009280211
1.1/2	52,0	68	40	25,00	1	009280212
1.5/8	56,0	71	40	28,00	1	009280214
1.11/16	58,8	74	40	32,50	1	009280215
1.13/16	62,3	75	43	36,00	1	009280217
1.7/8	65,0	78	43	38,50	1	009280218
2	68,3	80	43	44,50	1	009280219
2.1/16	71,5	83	48	52,00	1	009280220

## 928ME

chave de caixa com ponta macho hexagonal

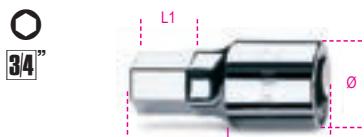

mm	Ø	L	L1	€	U	W
mm	mm	mm	mm			
14	35	75	15,5	34,00	2	009280514
17	35	75	15,5	34,00	2	009280517
19	35	75	15,5	34,00	2	009280519
22	35	75	22,5	34,00	2	009280522

## 928/15

redução quadra fêmea de 3/4" para quadra macho de 1/2"



UNI/ISO 3316  
DIN 3123

L	Ø	mm	mm	mm	mm	€	U	W
mm	mm	mm	mm	mm	mm			
51,5	34	3/4	1/2	17,50	5	009280801		



Aplique sempre uma força de aperto regular e progressiva, a fim de evitar a ruptura do material e de se proteger de um possível acidente

# Beta

## 928/16

adaptador quadra fêmea de 3/4" para quadra macho de 1"



UNI/ISO 3316  
DIN 3123

L	Ø	mm	mm	mm	mm	€	U	W
mm	mm	mm	mm	mm	mm			
65	34	3/4	1"	21,30	5	009280807		

## 928/20 - 928/21 - 928/22

extensões com quadras macho e fêmea de 3/4"

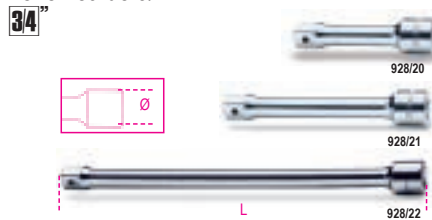

UNI/ISO 3316  
DIN 3123

	L	Ø	mm	mm	€	U	W
	mm	mm	mm	mm			
928/20	100	34	20,80	3	009280810		
928/21	200	34	28,50	3	009280815		
928/22	380	34	42,00	3	009280825		

## 928/25

cardan com quadras macho e fêmea 3/4"



UNI/ISO 3316 DIN 3123

L	Ø	mm	mm	€	U	W
mm	mm	mm	mm			
108	40	72,00	1	009280830		

## 928/36A

cabo articulado, quadra de 3/4" com punho



L	mm	€	U	W
mm	mm			
545	86,50	1	009280844	

## 928/42

cabo T corrediço, quadra de 3/4"

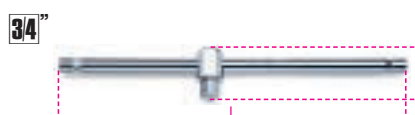

UNI/ISO 3315 DIN 3122

L	A	mm	mm	€	U	W
mm	mm	mm	mm			
450	62,5	45,50	3	009280850		

## 928/55

roquete reversível com quadra de 3/4" 72 dentes



L	Ø	A	mm	mm	mm	€	U	W
mm	mm	mm	mm	mm	mm			
510	58	59	145,00	2	009280862			

Ver quadro depois do artigo 929/C8 para acessórios compatíveis usados

## 928.../C12

jogo de 12 chaves de caixa hexagonal e 5 acessórios em caixa metálica



928A/C12	€	U	W
	714,00	1	009280955

928A	22 - 24 - 27 - 30 - 32 - 34 - 36 38 - 41 - 46 - 50 - 55 mm
928/21	200 mm
928/22	380 mm
928/25	
928/42	
928/55	

530x220x80 mm - 13,5 kg

928B/C12	€	U	W
	714,00	1	009280957

928B	22 - 24 - 27 - 30 - 32 - 34 - 36 38 - 41 - 46 - 50 - 55 mm
928/21	200 mm
928/22	380 mm
928/25	
928/42	
928/55	

530x220x80 mm - 13,5 kg

## 928AS/C12

jogo de 12 chaves de caixa hexagonal e 6 acessórios em caixa metálica



928AS/C12 € 742,00 1 009280968

	928AS	7/8-15/16-1.1/16-1.1/8-1.1/4 1.5/16-1.7/16-1.1/2-1.11/16 1.13/16-1.7/8-2.1/16
	928/21	200 mm
	928/22	380 mm
	928/25	
	928/42	
	928/55	

530x220x80 mm - 13,5 kg

## 929

chaves de caixa com boca hexagonal

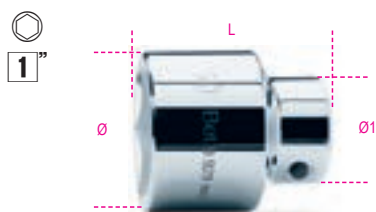

UNI/ISO 2725 DIN 3124

Ø	Ø	L	Ø1	€	1	009290036
mm	mm	mm	mm			
36	49,5	65	48	40,50	1	009290036
41	56,0	70	48	42,00	1	009290041
46	62,0	75	48	44,50	1	009290046
50	67,5	80	48	51,00	1	009290050
55	74,0	85	54	56,00	1	009290055
60	80,0	90	54	65,50	1	009290060
65	86,0	95	54	71,00	1	009290065
70	92,0	100	60	83,00	1	009290070
75	99,0	110	60	92,00	1	009290075
80	106,0	120	60	101,50	1	009290080

## 929/15

redução quadra fêmea de 1" para quadra macho de 3/4"



UNI/ISO 3316 DIN 3123

L	Ø	1"	3/4"	€	2	009290801
mm	mm					
65	47	1"	3/4"	37,00	2	009290801



Aplique sempre uma força de aperto regular e progressiva, a fim de evitar a ruptura do material e de se proteger de um possível acidente

## 929/21 - 929/22

extensões com quadras macho e fêmea de 1"



UNI/ISO 3316 DIN 3123

	L	Ø	€	1	009290815
	mm	mm			
929/21	200	47	49,00	1	009290815
929/22	400	47	69,00	1	009290825

## 929/42

cabo T correção, quadra de 1"



UNI/ISO 3315 DIN 3122

L	€	1	009290850
mm			
535	90,00	1	009290850

## 929/55

roquete reversível, quadra de 1" 72 dentes



UNI/ISO 3315 DIN 3122

L	Ø	A	€	1	009290860
mm	mm	mm			
770	62	63	191,00	1	009290860

## 929/C8

jogo com 8 chaves de caixa e 5 acessórios



929/C8 € 1.171,00 1 009290925

	929	46 - 50 - 55 - 60 - 65 70 - 75 - 80 mm □ 1" - ■ 3/4"
	929/15	
	929/21	200 mm
	929/22	400 mm
	929/42	
	929/55	

560x290x12 mm - 29 kg

## 900/R55



900/R55 € 32,00 1 009000871  
900/55

## 900M/R55



900M/R55 € 15,90 1 009000888  
900M/55

## 910/R55



910/R55 € 31,50 1 009100879  
606/6-606/10-612  
666/6-666/10-910/55  
599DGT/6

## 910M/R55



910M/R55 € 16,90 1 009100888  
910M/55-910M/56

## 910/R55Q



910/R55Q € 31,50 1 009100877  
910/55Q

## 910/R55X



910/R55X € 32,00 1 009100897  
666N/2X

## 920/R50



920/R50  
614/50-667/20-667/30  
920/50

€ 31,00 1 009200866

## 920/R55



920/R55  
606/20-606/30-666/20-666/30  
920/55-920/56A- 599DGT/20-599DGT/30

€ 37,00 1 009200879

## 920M/R55



920M/R55  
920M/55-920M/56

€ 18,60 1 009200888

## 920/R55Q



920/R55Q  
920/55Q

€ 37,00 1 009200877

## 920/R55X



920/R55X  
606/10X-612X  
666/10X-920/55X-599DGT/10X

€ 31,00 1 009200878

## 920/R55LC



920/R55LC  
920/55LC "Locking System"

€ 39,00 1 009200887

## 928/R55



928/R55  
928/55

€ 60,50 1 009280859

## 928/R55X



928/R55X  
614X

€ 38,50 1 009280858

## 929/R55



929/R55  
929/55

€ 71,00 1 009290859

## 930

chaves tubulares de 12 faces,  
serviço pesado



UNI 6745

mm	L	Ø	Ø1	€	1	009300006
6x7	100	9,5	11,0	12,00	3	009300006
8x9	108	12,5	14,0	14,90	3	009300010
10x11	116	15,0	16,5	15,50	3	009300014
12x13	124	17,5	19,0	18,50	3	009300018
14x15	132	20,0	21,5	20,20	3	009300023
16x17	140	23,0	24,0	23,30	3	009300027
18x19	148	25,0	26,5	25,50	3	009300032
20x22	156	28,0	30,0	28,50	2	009300036
21x23	163	29,0	31,5	31,00	2	009300040
24x26	173	33,0	35,5	39,00	2	009300044
25x28	182	34,5	38,0	42,00	2	009300048
27x29	191	37,0	39,5	48,00	2	009300052
30x32	200	40,5	43,0	57,50	2	009300056



930/S8  
6x7-8x9-10x11  
12x13-14x15-16x17  
18x19-20x22 mm  
940/1 - /2

€ 170,00 1 009300081

930/S13  
6x7-8x9-10x11-12x13  
14x15-16x17-18x19  
20x22-21x23-24x26  
25x28-27x29-30x32 mm  
940/1 - /2 - /3

€ 398,00 1 009300083



930/C13  
6x7-8x9-10x11-12x13  
14x15-16x17-18x19  
20x22-21x23-24x26  
25x28-27x29-30x32 mm  
940/1 - /2 - /3

€ 438,00 1 009300098

## 932

chaves de cachimbo 6 faces/12 faces  
em cromado brilhante

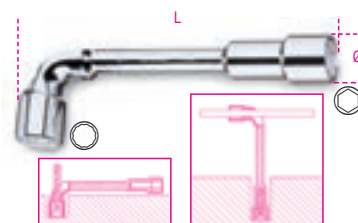

NF E 74.303

mm	Ø	L	€	1	009320006
6x6	11,5	110	13,50	5	009320006
7x7	12,5	116	13,70	5	009320007
8x8	13,0	120	14,20	5	009320008
9x9	14,0	125	14,80	5	009320009
10x10	16,5	133	15,30	5	009320010
11x11	17,5	143	16,60	5	009320011
12x12	19,0	148	17,70	5	009320012
13x13	19,5	154	18,40	5	009320013
14x14	21,5	167	19,30	5	009320014
15x15	22,5	182	20,40	5	009320015
16x16	24,5	193	21,30	5	009320016
17x17	26,0	198	21,50	5	009320017
18x18	26,5	215	23,50	5	009320018
19x19	29,0	220	26,00	5	009320019
20x20	30,5	222	27,50	3	009320020
21x21	30,5	236	32,00	3	009320021
22x22	32,5	250	35,00	2	009320022
23x23	33,5	256	38,50	2	009320023
24x24	35,0	272	40,50	2	009320024
25x25	36,5	282	44,00	2	009320025
26x26	37,5	296	48,00	2	009320026
27x27	39,0	296	51,00	2	009320027
28x28	39,0	314	57,00	2	009320028
30x30	42,5	348	67,50	2	009320030
32x32	45,5	364	75,50	2	009320032



932/S11  
6-7-8-10-11-12  
13-14-17-19-22 mm

€ 211,00 1 009320080

932/S17  
6-7-8-9-10-11-12  
13-14-15-16-17  
18-19-20-21-22 mm

€ 349,00 1 009320081

932/S25  
6-7-8-9-10-11-12-13  
14-15-16-17-18-19  
20-21-22-23-24-25  
26-27-28-30-32 mm

€ 769,00 1 009320082

## 933

chaves de cachimbo hexagonal em cromado brilhante

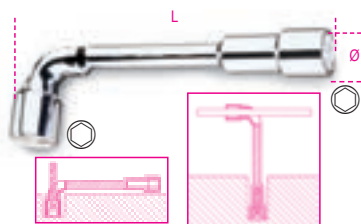

NF E 74.303

Ø mm	Ø mm	L mm	€	🔧	📦
6x6	11,5	110	13,50	5	009330006
7x7	12,5	116	13,70	5	009330007
8x8	13,0	120	14,20	5	009330008
9x9	14,0	125	14,80	5	009330009
10x10	16,5	133	15,30	5	009330010
11x11	17,5	143	16,60	5	009330011
12x12	19,0	148	17,70	5	009330012
13x13	19,5	154	18,40	5	009330013
14x14	21,5	167	19,30	5	009330014
15x15	22,5	182	20,40	5	009330015
16x16	24,5	193	21,30	5	009330016
17x17	26,0	198	21,50	5	009330017
18x18	26,5	215	23,50	5	009330018
19x19	29,0	220	26,00	5	009330019
20x20	30,5	222	27,50	3	009330020
21x21	30,5	236	32,00	3	009330021
22x22	32,5	250	35,00	2	009330022
23x23	33,5	256	38,50	2	009330023
24x24	35,0	272	40,50	2	009330024
25x25	36,5	282	44,00	2	009330025
26x26	37,5	296	48,00	2	009330026
27x27	39,0	296	51,00	2	009330027
28x28	39,0	314	57,00	2	009330028
30x30	42,5	348	67,50	2	009330030
32x32	45,5	364	75,50	2	009330032



933/S11	€	🔧	📦
6-7-8-10-11-12	211,00	1	009330080
13-14-17-19-22 mm			
933/S17	349,00	1	009330081
6-7-8-9-10-11-12			
13-14-15-16-17			
18-19-20-21-22 mm			
933/S25	769,00	1	009330082
6-7-8-9-10-11-12-13			
14-15-16-17-18-19			
20-21-22-23-24-25			
26-27-28-30-32 mm			

## 935

chaves tubulares hexagonais, série ligeira



UNI 6746 DIN 896

Ø mm	L mm	€	🔧	📦
6x7	100	7,00	5	009350105
8x9	110	7,55	5	009350111
10x11	120	8,20	5	009350115
12x13	130	9,30	5	009350117
14x15	140	10,90	5	009350126
16x17	150	11,80	5	009350128
18x19	160	14,20	5	009350131
20x22	170	17,20	3	009350138
21x23	180	19,10	3	009350141
24x26	190	21,80	3	009350144
25x28	200	23,50	2	009350150
27x29	210	28,00	2	009350153
30x32	220	30,00	2	009350156

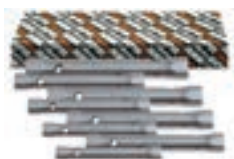

935/S8	€	🔧	📦
6x7-8x9-10x11	98,00	1	009350181
12x13-14x15-16x17			
18x19-20x22 mm			
940/1 - /2			
935/S13	232,00	1	009350183
6x7-8x9-10x11			
12x13-14x15-16x17			
18x19-20x22-21x23			
24x26-25x28-27x29			
30x32 mm			
940/1 - /2 - /3			

## 937

chaves de cachimbo 6 faces/12 faces cromadas

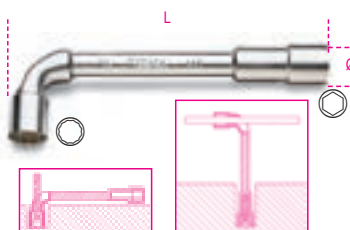

Ø mm	Ø mm	L mm	€	🔧	📦
6x6	11,5	110	7,35	5	009370006
7x7	12,5	116	7,65	5	009370007
8x8	13,0	120	8,00	5	009370008
9x9	14,0	125	8,40	5	009370009
10x10	16,5	133	8,75	5	009370010
11x11	17,5	143	9,30	5	009370011
12x12	19,0	148	10,10	5	009370012
13x13	19,5	154	10,60	5	009370013
14x14	21,5	167	11,50	5	009370014
15x15	22,5	182	12,90	5	009370015
16x16	24,5	193	13,80	5	009370016
17x17	26,0	198	14,40	5	009370017
18x18	26,5	215	14,80	5	009370018
19x19	29,0	220	15,30	5	009370019
20x20	30,5	222	17,40	3	009370020
21x21	30,5	236	19,10	3	009370021
22x22	32,5	250	20,20	2	009370022
23x23	33,5	256	22,40	2	009370023
24x24	35,0	272	23,50	2	009370024
25x25	36,5	282	29,50	2	009370025
26x26	37,5	296	31,00	2	009370026
27x27	39,0	296	31,50	2	009370027
28x28	39,0	314	37,50	2	009370028
30x30	42,5	348	40,50	2	009370030
32x32	45,5	364	45,00	2	009370032



937/S11	€	🔧	📦
6-7-8-10-11-12	123,00	1	009370080
13-14-17-19-22 mm			
937/S17	209,00	1	009370081
6-7-8-9-10-11-12			
13-14-15-16-17			
18-19-20-21-22 mm			

## 940

passadores para chaves tubulares ref. 930 e 935



	Ø mm	L mm	€	🔧	📦
940/1	6÷13	100	4,95	5	009400001
940/2	14÷22	170	6,55	5	009400002
940/3	21÷32	290	12,00	5	009400003

## 941

chave de caixa sextavada/bisextavada, com punho de binário elevado

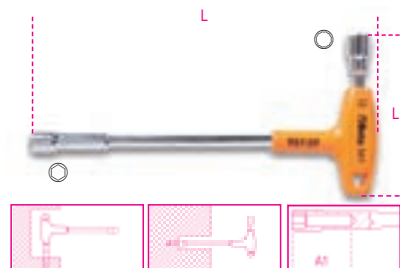

Ø mm	L mm	L1 mm	A1 mm	€	🔧	📦
7x7	200	91	35	24,40	2	009410107
8x8	220	107	50	26,00	2	009410108
9x9	220	109	50	26,50	2	009410109
10x10	236	111	50	27,50	2	009410110
11x11	236	114	50	28,50	2	009410111
12x12	255	122	50	31,50	2	009410112
13x13	255	124	55	32,00	2	009410113



941/S7	€	🔧	📦
7-8-9-10-11-12-13 mm	196,00	1	009410170

## 942BX

chave de caixa com punho sextavada de binário elevado modelo curto



UNI 6750

Ø mm	L mm	L1 mm	A1 mm	€	🔧	📦
4	190	70	13,0	12,40	5	009420003
5	190	70	14,0	12,40	5	009420004
5,5	190	70	12,5	14,10	5	009420005
6	190	70	14,5	14,10	5	009420006
7	190	70	15,5	14,70	5	009420007
8	202	70	18,5	14,70	5	009420008
9	202	70	19,5	14,70	5	009420009
10	202	70	20,5	15,70	3	009420010
11	202	70	21,5	15,70	3	009420011
12	202	70	22,5	15,70	3	009420012
13	202	70	23,5	17,50	3	009420013
14	202	70	24,5	17,50	3	009420014



**942BX/S12** € 179,00 1 009420030  
4-5-5,5-6-7-8-9  
10-11-12-13-14 mm

### 943BX

chave de caixa com punho sextavada de binário elevado modelo longo



ISO 2236 UNI 6750

Ø mm	L mm	L1 mm	A1 mm	€	U	U
4	270	150	13,0	13,80	5	009430003
5	270	150	14,0	13,80	5	009430004
5,5	270	150	12,5	14,90	5	009430005
6	270	150	14,5	14,90	5	009430006
7	270	150	15,5	16,00	5	009430007
8	282	150	18,5	16,00	5	009430008
9	282	150	19,5	16,00	5	009430009
10	282	150	20,5	17,20	3	009430010
11	282	150	21,5	17,20	3	009430011
12	282	150	22,5	17,20	3	009430012
13	282	150	23,5	18,30	3	009430013
14	282	150	24,5	18,30	3	009430014



**943BX/S12** € 193,00 1 009430030  
4-5-5,5-6-7-8-9  
10-11-12-13-14 mm



**943BX/D6** € 96,00 1 009430026  
5-6-7-8-10-13 mm



### 943FL

chaves de caixa hexagonal flexível com punho



Ø mm	L mm	L1 mm	Ø mm	€	U	U
5	265	150	8	19,20	2	009430304
5,5	265	150	8	19,20	2	009430305
6	265	150	9	19,20	2	009430306
7	265	150	11	19,20	2	009430307
8	265	150	12	20,00	2	009430308
10	290	175	14	21,10	2	009430310



**943FL/S6** € 118,00 1 009430320  
5-5,5-6-7-8-10 mm

### 944BX

chave de caixa com punho sextavada profunda de binário elevado modelo longo



ISO 2236 UNI 6750

Ø mm	L mm	L1 mm	A1 mm	€	U	U
4	245	125	20	14,40	3	009440003
5	245	125	25	14,40	3	009440004
5,5	245	125	30	17,80	3	009440005
6	245	125	35	17,80	3	009440006
7	245	125	35	17,80	3	009440007
8	257	125	50	18,90	3	009440008
9	257	125	50	18,90	3	009440009
10	257	125	50	19,70	3	009440010
11	257	125	50	19,70	3	009440011
12	257	125	50	21,30	3	009440012
13	257	125	55	21,30	3	009440013
14	257	125	55	21,30	3	009440014



**944BX/S12** € 223,00 1 009440062  
4-5-5,5-6-7-8-9  
10-11-12-13-14 mm



**944BX/D6** € 110,00 1 009440056  
5-6-7-8-10-13 mm

### 949

chaves de caixa com punho em T

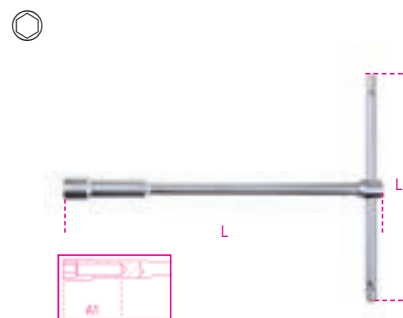

Ø mm	L mm	L1 mm	A1 mm	€	U	U
8	220	160	50	25,50	2	009490008
10	230	160	50	27,00	2	009490010
12	240	175	50	28,00	2	009490012
13	244	175	55	29,00	2	009490013
14	250	190	55	31,50	2	009490014
17	264	200	60	35,50	2	009490017



**949/S6** € 176,00 1 009490076  
8-10-12-13-14-17mm



## 950

chaves de caixa simples hexagonal com punho em T

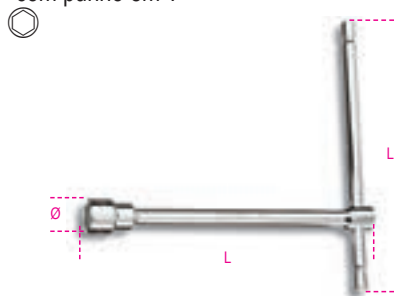

UNI 6742 DIN 3112

mm	L	Ø	L1	€	🔧	📄
6	210	10,1	145	18,00	3	009500006
7	212	11,2	145	18,00	3	009500007
8	220	12,4	160	19,20	3	009500008
9	223	13,5	160	19,20	3	009500009
10	230	14,9	160	21,00	3	009500010
11	233	16,1	160	21,00	3	009500011
12	240	17,5	175	23,20	3	009500012
13	244	19,7	175	23,30	3	009500013
14	250	20,1	190	26,00	3	009500014
15	254	21,5	190	27,00	3	009500015
16	260	22,7	200	30,00	3	009500016
17	264	24,1	200	31,50	3	009500017
19	274	26,6	230	38,50	3	009500019
22	290	29,9	290	46,50	2	009500022
24	300	32,2	320	53,00	2	009500024
27	315	36,2	370	63,00	2	009500027



<b>950/S9</b>	221,00	1	009500079
7-8-10-11-12 13-14-17-19 mm			
<b>950/S14</b>	361,00	1	009500082
6-7-8-9-10-11-12-13 14-15-16-17-19-22 mm			

## 951

chaves em T com macho hexagonal articulado

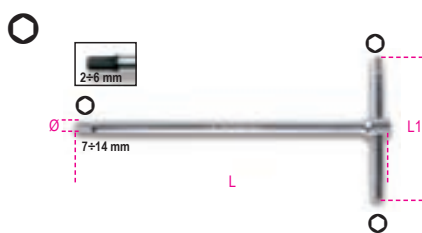

mm	L	L1	Ø	€	🔧	📄
2	125	63	4,0	16,40	5	009510521
2,5	150	63	4,0	16,40	5	009510525
3	150	63	4,0	16,40	5	009510530
3,5	175	76	5,5	16,90	5	009510535
4	175	76	5,5	16,90	5	009510540
4,5	195	87	6,5	18,60	5	009510545
5	195	87	6,5	18,60	5	009510550
6	215	99	8,0	21,50	5	009510560
7	230	109	9,0	23,20	5	009510570
8	250	122	10,0	23,20	5	009510580
9	265	132	11,0	29,00	5	009510590
10	280	142	12,0	29,00	5	009510610
12	305	160	15,0	39,50	3	009510620
14	330	178	17,0	49,00	3	009510640

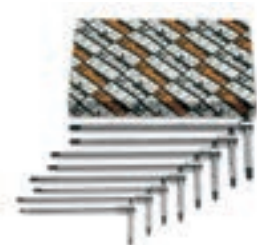

<b>951/S6</b>	113,00	1	009510687
2,5-3-4-5-6-8 mm			
<b>951/S8</b>	142,00	1	009510693
2-2,5-3-3,5-4-4,5-5-6 mm			
<b>951/S14</b>	334,00	1	009510695
2-2,5-3-3,5-4-4,5 5-6-7-8-9-10-12-14 mm			



<b>951/SP6</b>	145,00	1	009510696
3-4-5-6-8-10 mm			
<b>951/SPV</b>	25,00	1	009510697

## 951AS

chaves em T com macho hexagonal articulado

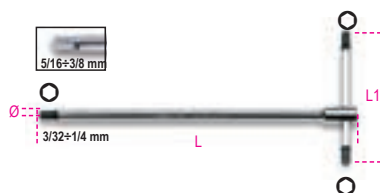

"	L	L1	Ø	€	🔧	📄
3/32	125	63	4,0	21,50	2	009510750
7/64	150	63	4,0	21,50	2	009510751
1/8	150	63	4,0	21,50	2	009510752
9/64	175	76	5,5	22,60	2	009510753
5/32	175	76	5,5	22,60	2	009510754
3/16	195	86	6,5	24,90	2	009510755
7/32	215	99	8,0	24,90	2	009510757
1/4	230	109	9,0	28,00	2	009510758
5/16	250	122	10,0	29,00	2	009510759
3/8	280	142	12,0	35,50	2	009510760

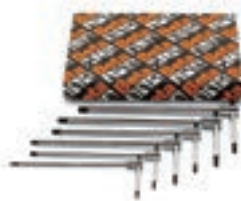

<b>951AS/S6X</b>	164,00	1	009510771
1/8-3/16-7/32-1/4-5/16-3/8			

## 951TX

chaves em T com pontas para parafusos de perfil Torx®, articulado



mm	L	L1	Ø	€	🔧	📄
<b>T6</b>	125	63	4	20,10	3	009510806
<b>T7</b>	125	63	4	20,10	3	009510807
<b>T8</b>	125	63	4	20,70	3	009510808
<b>T9</b>	125	63	4	20,70	3	009510809
<b>T10</b>	150	63	4	21,30	3	009510810
<b>T15</b>	150	63	4	21,30	3	009510815
<b>T20</b>	175	76	5	22,40	3	009510820
<b>T25</b>	175	76	5	22,40	3	009510825
<b>T27</b>	195	87	6	24,20	3	009510827
<b>T30</b>	195	87	6	24,20	3	009510830
<b>T40</b>	215	99	7	27,50	3	009510840
<b>T45</b>	230	109	8	29,50	3	009510845
<b>T50</b>	250	122	9	32,00	3	009510850

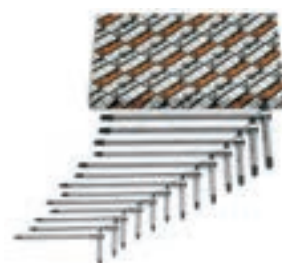

<b>951TX/S6</b>	132,00	1	009510866
T8-T10-T15-T20-T25-T30			
<b>951TX/S13</b>	306,00	1	009510863
T6-T7-T8-T9-T10-T15-T20-T25 T27-T30-T40-T45-T50			

## 952

chaves de caixa hexagonais com cardam e cabo em T

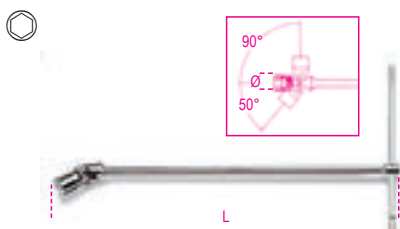

UNI 6743

mm	Ø	L	€	🔧	📄
<b>6</b>	9,5	395	27,50	5	009520006
<b>7</b>	10,7	395	27,50	5	009520007
<b>8</b>	12,1	395	27,50	5	009520008
<b>9</b>	13,2	395	27,50	5	009520009
<b>10</b>	14,6	400	30,00	5	009520010
<b>11</b>	15,8	400	30,00	5	009520011
<b>12</b>	17,0	400	30,00	5	009520012
<b>13</b>	18,7	432	32,50	5	009520013
<b>14</b>	19,7	432	32,50	5	009520014
<b>15</b>	20,9	450	40,00	3	009520015
<b>16</b>	22,0	450	40,00	3	009520016
<b>17</b>	23,4	450	40,00	3	009520017
<b>18</b>	24,7	450	40,00	3	009520018
<b>19</b>	26,0	500	49,00	3	009520019
<b>20</b>	27,4	500	49,00	3	009520020
<b>21</b>	28,5	500	49,00	3	009520021
<b>22</b>	29,7	500	49,00	3	009520022
<b>24</b>	32,4	500	49,00	3	009520024



	€		
<b>952/S7</b> 8-10-11-13-14-17-19 mm	240,00	1	009520074
<b>952/S10</b> 7-8-10-11-12-13-14-15-17-19 mm	337,00	1	009520080
<b>952/S18</b> 6-7-8-9-10-11-12-13-14-15-16-17-18-19-20-21-22-24 mm	666,00	1	009520083

## 952AS

chaves de caixa hexagonais com cardan e cabo em T

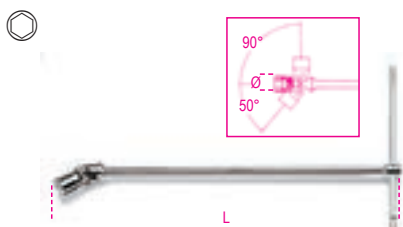

"	Ø mm	L mm	€		
1/4	9,5	395	31,00	2	009520256
5/16	12,1	395	31,00	2	009520258
3/8	14,6	400	33,00	2	009520260
7/16	15,8	400	33,00	2	009520261
1/2	18,7	432	37,00	2	009520263
9/16	19,7	432	40,00	2	009520264
5/8	22,0	450	43,00	2	009520266
11/16	23,4	450	43,00	2	009520267
3/4	26,0	500	53,00	2	009520269

## 952L

chaves de caixa hexagonais com cardan e cabo em T série longa

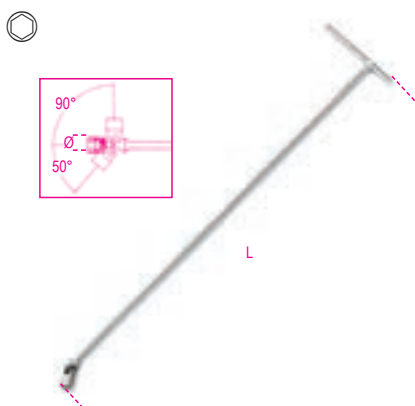

mm	Ø mm	L mm	€		
10	14,6	930	76,00	1	009520410
12	17,0	1063	76,00	1	009520412
13	18,7	1100	76,00	1	009520413
14	19,7	1100	76,00	1	009520414
15	20,9	1100	84,50	1	009520415
16	22,0	1100	84,50	1	009520416
17	23,4	1100	84,50	1	009520417
18	24,7	1100	84,50	1	009520418
19	26,0	1100	98,00	1	009520419

## 952FTX

chaves de caixa com cardan e cabo em T, para parafusos com perfil Torx®

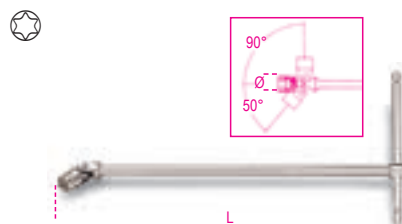

	Ø mm	L mm	€		
<b>E6</b>	8	392	33,00	2	009520106
<b>E7</b>	9	392	33,00	2	009520107
<b>E8</b>	10	395	37,50	2	009520108
<b>E10</b>	13	400	38,50	2	009520110
<b>E12</b>	15	440	46,50	2	009520112
<b>E14</b>	17	490	57,00	2	009520114
<b>E16</b>	19	490	57,00	2	009520116
<b>E18</b>	21	490	57,00	2	009520118
<b>E20</b>	23	490	57,00	2	009520120



	€		
<b>952FTX/S9</b> E6-E7-E8-E10-E12 E14-E16-E18-E20	414,00	1	009520141

## 953

chaves em T com macho hexagonal articulado

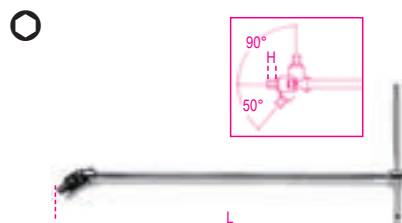

UNI 6754

mm	H mm	L mm	€		
3	5	395	28,50	5	009530130
3,5	6	395	28,50	3	009530135
4	6	395	28,50	5	009530140
4,5	7	395	28,50	3	009530145
5	7	395	28,50	5	009530150
6	9	400	31,00	5	009530160
7	10	425	34,00	3	009530170
8	11	425	34,00	5	009530180
10	13	440	41,00	5	009530200



	€		
<b>953/S5</b> 3-4-5-6-8 mm	150,00	1	009530305
<b>953/S9</b> 3-3,5-4-4,5 5-6-7-8-10 mm	281,00	1	009530301

## 953TX

chaves em T com macho de perfil Torx® articulado

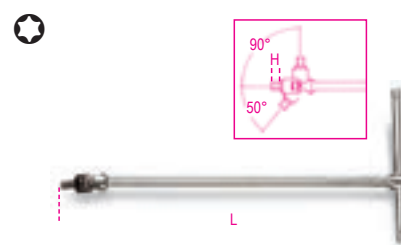

	H mm	L mm	€		
<b>T20</b>	11	396	35,00	2	009530020
<b>T25</b>	11	396	35,00	2	009530025
<b>T27</b>	11	396	35,00	2	009530027
<b>T30</b>	13	400	38,50	2	009530030
<b>T40</b>	13	400	38,50	2	009530040
<b>T45</b>	13	426	40,00	2	009530045
<b>T50</b>	14	442	47,00	2	009530050
<b>T55</b>	14	442	47,50	2	009530055



	€		
<b>953TX/S8</b> T20-T25-T27-T30 T40-T45-T50-T55	316,00	1	009530060

## 955

chave tubular para velas

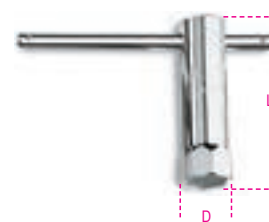

mm - "	D mm	L mm	€		
16	21	86	13,90	3	009550016
5/8	20,8	86	13,90	3	009550021
13/16					

## 956C

chaves de caixa para velas quadra fêmea de 1/2"



ISO 11168

mm - "	Ø mm	L mm	€		
14	18,8	70	25,50	3	009560008
9/16					
16	21,4	70	25,50	3	009560010
5/8					
17,8	23,6	70	25,50	3	009560011
11/16					
20,8	27,0	70	25,50	3	009560012
13/16					



## 956E

chaves de caixa para velas quadra fêmea de 3/8"



ISO 11168

mm -"	Ø mm	L mm	€	Hand	Tool
14	18,8	70	28,00	3	009560018
9/16					
16	21,4	70	28,00	3	009560020
5/8					
17,8	23,6	70	28,00	3	009560021
11/16					
20,8	27,0	70	28,00	3	009560022
13/16					

## 956F

chaves de caixa para velas quadra 3/8"



mm -"	Ø mm	L mm	€	Hand	Tool
14	18,8	70	32,00	1	009560114
9/16					
16	20,5	70	39,50	1	009560116
5/8					

## 956L

chaves de caixa para velas quadra de 1/2", extremidades hexagonal, série longa



mm -"	Ø mm	L mm	€	Hand	Tool
14	20,2	250	52,50	2	009560214
9/16					
16	24,0	250	54,50	2	009560216
5/8					
17,8	24,0	250	58,00	2	009560217
11/16					
20,8	28,5	250	59,00	2	009560221
13/16					

## 957

chaves em T para velas com cardan

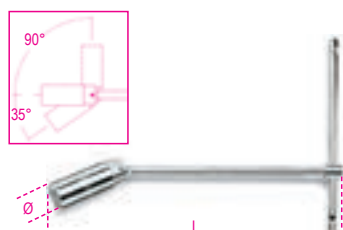

ISO 11168

mm -"	Ø mm	L mm	€	Hand	Tool
16	21,4	275	40,50	3	009570000
5/8					
20,8	27,0	275	47,50	3	009570001
13/16					

## 959

chaves em T para velas com cardan série normal

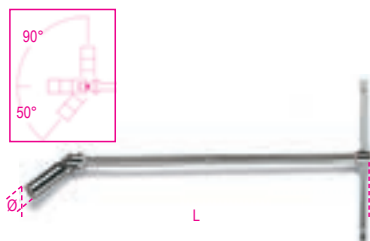

ISO 11168

mm -"	Ø mm	L mm	€	Hand	Tool
14	18,8	483	47,00	3	009590009
9/16					
16	21,4	483	52,00	3	009590010
5/8					
20,8	27,0	527	68,50	3	009590011
13/16					

## 959R

aplicações em borracha e molas de substituição para artigos 956C - 956E - 957 - 959

mm -"	Ø mm	L mm	€	Hand	Tool
959R/14			4,60	3	009590223
956C/14-956E/14					
959R/16			4,60	3	009590224
956C/16-956E/16					
957/16-959/16					
959R/17,8			4,60	3	009590225
956C/17,8-956E/17,8					
959R/20,8			4,60	3	009590226
956C/20,8-956E/20,8					
957/20,8-959/20,8-959L					

## 960

chave de caixa para injectores de motores Diesel, quadra fêmea de 1/2"



mm	Ø mm	L mm	€	Hand	Tool
27	36,5	77	30,00	2	009600027

## 960A

chave de caixa para injectores de motores Diesel, quadra fêmea de 1/2"

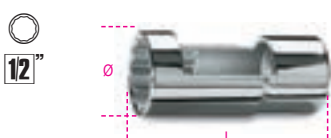

mm	Ø mm	L mm	€	Hand	Tool
27	36,5	77	43,50	2	009600017

## 960BT

Chave para ligações eléctricas de injectores

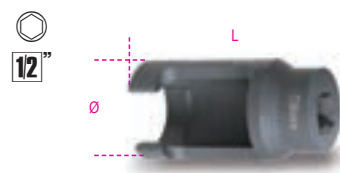

mm	Ø mm	L mm	€	Hand	Tool
25	37,0	78	73,50	1	009600125
27	39,7	78	73,50	1	009600127
29	42,0	78	73,50	1	009600129
30	43,0	78	73,50	1	009600130

## 960BT/B

chave de caixa para conectores eléctricos do injector

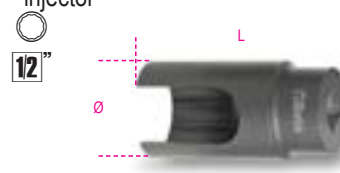

mm	Ø mm	L mm	€	Hand	Tool
29	38,5	77	106,00	1	009600128

## 960F

chave de caixa para porta-injectores



Ø mm	Ø1 mm	Ø2 mm	L mm	€	Hand	Tool
28,3	22	32	22	34,50	1	009600148

## 960G

chave de caixa para injectores especialmente indicada para os injectores Diesel dos camiões Mercedes-Benz

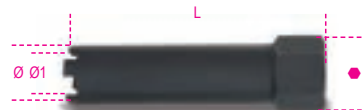

Ø mm	Ø1 mm	L mm	€	Hand	Tool	
28,5	22	32	122	37,00	1	009600151

## 960L

chave de caixa para injectores

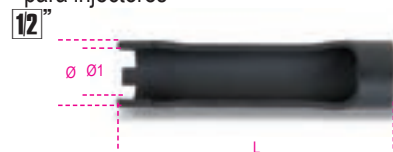

Ø mm	Ø1 mm	L mm	€	Hand	Tool
30	22	122	40,00	1	009600153

## 960M

chave de caixa para injectores

12"

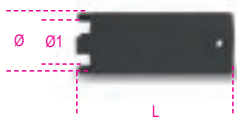

Ø mm	Ø1 mm	L mm	€	U	W
28,5	22	72	29,00	1	009600154

## 960H/C4

jogo de chaves de caixa para porta-injectores



960H/C4	€	U	W
	102,50	1	009600152

## 960S

chave de caixa para injectores de motores Diesel, quadra fêmea de 1/2"

12"



Ø mm	Ø mm	L mm	€	U	W
22	30	82	34,00	1	009600022

## 960SL

chaves de caixa para sonda Lambda com quadra fêmea de 1/2"

12"



	Ø mm	€	U	W
960SL85	33	52,00	2	009600085
○ 22xL= 85 mm				
960SL110	33	59,50	2	009600110
○ 22xL= 110 mm				

## 960SN

chaves para velas de incandescência de motores Diesel

14"

3/8"



Ø mm	Ø mm	□	L mm	€	U	W
8	12,0	1/4	60	45,00	2	009600834
9	13,3	1/4	60	45,00	2	009600835
10	14,5	3/8	70	52,50	2	009600836
11	15,8	3/8	70	52,50	2	009600837
12	17,0	3/8	70	52,50	2	009600838

## 960/22EP

chave dupla articulada, para sondas Lambda  
Cabeça dupla sextavada/bi-sextavada e junta 180° para extrema versatilidade



L mm	Ø mm	Ø mm	€	U	W
300	22	22	47,50	1	009600052

## 960AVE

dispositivo de teste de injectores eléctricos diesel commom rail



960AVE	€	U	W
	229,00	1	009600245

430x310x50 mm - 2,0 kg

## 960CMB

compressómetro para motores a gasolina



Bar	€	U	W
4÷17	551,00	1	009600250

440x370x100 mm - 2,2 kg

## 960CMB/R2

cartões de substituição para artigo 960CMB



960CMB/R2	€	U	W
	28,00	1	009600252

## 960CMD

compressómetro para motores Diesel



Bar	€	U	W
8÷40	600,00	1	009600270

440x370x100 mm - 2,4 kg

## 960CMD/R1

cartões de substituição para artigo 960CMD



960CMD/R1	€	U	W
	28,00	1	009600271

## 960EPC

jogo de ferramentas para remoção de eléctrodos de velas de incandescência



ZONA DI ROTTURA

960EPC	€	U	W
	555,00	1	009600790

270x230x80 mm - 900 g

# Beta

## 960E-PI/P

extractor de anilhas de injector

- Rosca macho M10 para utilização com o extractor de percussão (Beta 1540)



960E-PI/P € 58,50 1 009600706  
300x90x60 mm

## 960KC-M8/M9/M10

Jogo de ferramentas para remoção de velas de incandescência danificadas ou partidas

- Para velas de incandescência com rosca M8-M9-M10



960KC-M8/9/10 € 379,00 1 009600801  
380x290x50 mm - 2,3 kg

## 960KPC

Extractor por impulso reversível com binário ajustável para velas de incandescência

14"



960KPC € 287,00 1 009600780  
8-9-10-11-12 mm  
420x185x60 mm - 2,8 kg

## 960UC

Jogo de ferramentas para extração de velas de incandescência M8-M9-M10 com pontas danificadas



960UC € 442,00 1 009600900

## 960P

aparelho de teste de compressão/descompressão com acessórios e adaptadores



960P € 221,00 1 009600777  
350x320x95 mm - 1,9 kg

## 960PI

jogo de escareadores para limpeza do alojamento dos injectores em estojo de plástico

Para remover resíduos do alojamento do injector

- Escareador plano, Ø 19 - 15 mm, para injectores universais
- Escareador plano, Ø 17 - 17 mm, para injectores Delphi/Bosch (BMW/PSA/Renault/Ford)
- Escareador plano, Ø 19 - 17 mm, para injectores Bosch (Mercedes CDI).
- Escareador angular, Ø 21 - 17 mm, para injectores Fiat/Iveco
- Punho



960PI € 107,00 1 009600215  
250x130x50 mm - 600 g

## 960PI/C19

jogo de 19 ferramentas para limpeza de base de injectores

Inclui:

- 11 mandris planos, Ø: 14/14 mm - 15,5/15,5 mm - 15/19 mm - 17/19 mm - 17/17,5 mm - 17/19 mm - 17/19,5 mm - 17/20 mm - 18/21 mm - 19 mm - 20/21 mm
- 4 mandris angulares, Ø: 15,5/15,5 mm - 17/17 mm - 17,5/20,5 mm - 17/21 mm
- Acessórios para mandris e punhos



960PI/C19 € 262,00 1 009600217  
360x230x60 mm

## 960PI/S

kit limpeza do alojamento dos injectores

Inclui:

- 3 escovas de aço, Ø 18, 22, 25 mm, para limpeza de suportes de injectores
- 2 escovas, Ø 14 e 16 mm para limpeza do fundo dos suportes
- 6 tampas para o acesso à câmara de combustão
- 1 escova para limpeza do acesso à câmara de combustão
- 1 porta-bits flexível com punho

14"



960PI/S € 137,00 1 009600214  
360x140x50 mm - 700 g

## 960RPI

Soprador do alojamento dos injectores

Para velas de incandescência M8x1 - M9x1 - M10x1 - M10x1.25



960RPI € 169,00 1 009600940

## 960PMC

bomba manual para regulação e controlo de injectores Diesel



Bar Max. 400 € 671,00 1 009600200

## 960AVL

aspirador de fumos



Bar Max. 6 € 753,00 1 009600210

## 961D

videoscópio electrónico digital com sonda 5.5 mm

• Permite registar imagens individuais e vídeo clips, reproduzindo-os directamente na ferramenta



- sonda com cabeça Ø 5.5 mm e 90 cm de comprimento
- monitor TFT LCD, 7" (18 cm), com resolução 800x480
- câmara digital com visão frontal e lateral
- união rápida da sonda tipo "Cfast"
- frequência de repetição da imagem: 15 frames por segundo
- zoom digital 2x
- porta micro-USB para upload de imagens
- saída de vídeo micro-HDMI
- porta para cartão micro-SD
- porta micro-USB
- possibilidade de utilização durante o carregamento da bateria
- microfone e altifalante para registar/ouvir anotações de voz
- ligação Wi-Fi

961D € 1.535,00 1 009610500

400x340x85 mm - 2,6 kg

## 961D/CF3,8

sonda 1m com câmara frontal 3.8 mm para videoscópio 961D



961D/CF3,8 € 654,00 1 009610511

## 961D/DC8,5

sonda 1m com câmara UV dupla para videoscópio 961D



961D/DC8,5 € 567,00 1 009610513

## 961P6

videoscópio electrónico com sonda flexível



- Suporta cartões SD (8 GB)
- Suporta memórias flash (8 GB)
- Memória interna: 128M
- Saída para TV
- Suporta formato de vídeos (MP4, AVI, 3GP)
- 4 LEDs
- Alimentação por porta USB (bateria embutida)

### ESPECIFICAÇÕES

- Pixeis do sensor: 640x480
- Resolução máxima: 320x240
- Comprimento da sonda: 1 m
- Diâmetro da câmara: 6 mm
- Formato de vídeos: MPEG4, 3GP, AVI, ASF
- Formato de fotografias: JPEG
- Ângulo de disparo: 0+180°
- Saída de dados: Cabo USB e cartão SD
- Alimentação: bateria 3.7V 2000 mAh

961P6 € 653,00 1 009610000

## 961P6/S

sondas flexíveis, 6 mm



	L mm	€		
961P6/S2	2000	314,00	1	009610262
961P6/S3	3000	358,00	1	009610263

## 962

ferros de desmonta



L mm	A mm	€		
300	21	21,30	5	009620003
400	25	25,00	5	009620004
500	27	33,00	3	009620005
600	27	42,00	3	009620006

## 962P

alavanca de pneus com proteção anti-riscos



L mm	A mm	€		
490	25	78,50	1	009620049

## 962M

ferramenta para desmontagem/ montagem de pneus

Instalação de pneus runflat e baixo perfil em todos os equipamentos.

- mordentes anti-riscos
- base de alavanca para remoção do pneu



962M € 284,00 1 009620501

## 963

alavanca com extremidades chata e pontiaguda



L mm	A mm	€		
400	23	32,50	5	009630001

## 964

alavanca com extremidades pontiaguda e em cunha



L mm	A mm	€		
400	46	29,50	5	009640001

## 965

jogo de alavancas com pontas curvadas



L	A	L1	€	🔧	📦
300	16	185	14,80	2	009650013
450	20	312	21,00	2	009650014
600	20	462	24,60	2	009650016

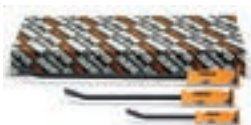

965/S3	€ 60,00	🔧 1	📦 009650019
--------	---------	-----	-------------

## 966/C3

Jogo 3 alavancas com cabeça articulada curvada

- Rotação da cabeça a 200°
- Bloqueio automático na posição pretendida



966/C3	€ 112,00	🔧 1	📦 009660103
--------	----------	-----	-------------

L=200-250-300 mm

355x140x65 mm - 1,8 kg

## 720LS

chaves de impacto, série longa



UNI/ISO 2725

mm	Ø	L	Ø1	€	🔧	📦
720LS 36	36	48,0	78	29	57,00	2 007200386

## 969B

chave de caixa para aperto da porca do cubo

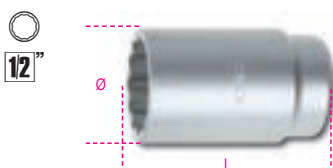

mm	Ø	L	€	🔧	📦
24	36,0	76	18,60	1	009690124
27	36,0	76	18,60	1	009690127
30	40,0	76	19,70	1	009690130
31	42,0	76	19,70	1	009690131
32	42,5	76	20,80	1	009690132
34	45,0	76	23,50	1	009690134
35	46,0	76	24,00	1	009690135
36	49,0	76	27,50	1	009690136

## 969/C5

jogo de 5 chaves de caixa para cubos de roda em estojo de plástico

12"



969/C5	€ 115,00	🔧 1	📦 009690201
--------	----------	-----	-------------

969B 30-32-34-35-36

## 970EA

chave de impacto para cubos de roda

3/4"



mm	mm	Ø	€	🔧	📦
98	36	122	221,00	1	009700398

## 970EB

chave de impacto para cubos de roda

12"



mm	mm	Ø	€	🔧	📦
95	36	126	259,00	1	009700595
110	36	133	264,00	1	009700410

## 970Q

chave de impacto para porcas rectangulares

3/4"



L	mm	€	🔧	📦
56	3/4"	100,50	1	009700756
60	3/4"	106,00	1	009700760

## 970B

chave de caixa para aperto da porca do cubo Fiat Daily

1"

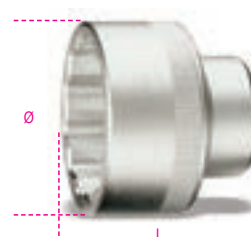

mm	Ø	L	€	🔧	📦
65	88	75	94,00	1	009700010

## 970C

chave de caixa octogonal para aperto de cubos de roda



mm	□ - Ø	€	🔧	📦
80	41 mm	142,00	1	009700808
95	3/4"	202,00	1	009700815
100	3/4"	208,00	1	009700820
109	41 mm	213,00	1	009700829
115	3/4"	213,00	1	009700835
120	41 mm	218,00	1	009700840

## 970OT

chave de caixa oval para aperto de cubos de rodas de trailers



L	L1	□ - Ø	€	🔧	📦
65	61	3/4"	123,00	1	009700165
80	73	3/4"	140,00	1	009700180
96	90	3/4"	152,00	1	009700196
111	104	41 mm	199,00	1	009700211

## 971TSP

sensor de pressão para pneus



### ESPECIFICAÇÕES

- leitura do sensor TPMS, incluindo: sensor ID
- impressão de enchimento
- temperatura
- estado da bateria
- activação do sensor
- programação universal do sensor

A ferramenta possui uma base de dados que suporta operações de reparação, nomeadamente:

- torques
- códigos das peças originais e sensores universais compatíveis

971TSP	€ 1.080,00	1	009710025
63x142x30 mm			

## 971/C8

chave de aperto para válvulas de pneus, com acessórios e sistema de controlo de pressão para um aperto controlado



971/C8	€ 354,00	1	009710108
--------	----------	---	-----------

	583/6	1,2+6 Nm
	892/0	
	862TX	T10-T15-T20
	900L	11-12 mm
	986 78	

## 978 - 979

chaves de cruz para porcas de rodas

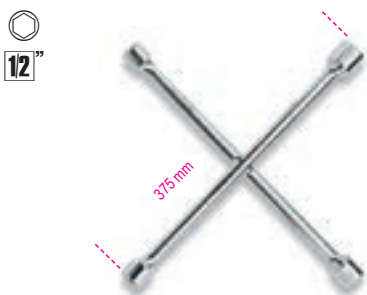

UNI/ISO 6788 DIN 3119

978	€ 57,00	2	009780001
17x19x21x22 mm			
979	€ 57,00	2	009790001
17x19x22x22x1/2 mm			

## 982

chaves de cruz para porcas de rodas



UNI/ISO 6788 DIN 3119

24x27x32x3/4 mm	€ 137,00	1	009820001
-----------------	----------	---	-----------

## 984

Alicate para tampa de plástico da porca da roda



L mm	H mm	€	1	009840005
195	4	21,80		

## 985/B7

jogo 7 pinos-guia para rodas

Tamanhos:

- M12x1.25 macho
- M12x1.25 fêmea
- M12x1.5 macho
- M12x1.5 fêmea
- M14x1.25 macho
- M14x1.5 macho
- M16x1.5 macho



985/B7	€ 89,00	1	009850007
--------	---------	---	-----------

## 985M

pinos-guia macho para rodas



	L mm	€	1	
985M M12X1,25	150	10,90		009850101
985M M12X1,50	150	10,90		009850102
985M M14X1,25	150	11,50		009850103
985M M14X1,50	150	11,50		009850104
985M M16X1,50	150	12,60		009850105

## 985F

pinos-guia fêmea para rodas



	L mm	€	1	
985F M12X1,25	150	14,80		009850106
985F M12X1,50	150	15,90		009850107

## 986 48

Chave de fendas para válvulas de pneus, modelo curto

Válvula de retenção automática

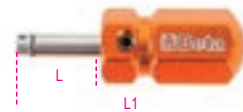

L mm	L1 mm	€	1	009860048
18	48	12,60		

## 986 78

Chave de fendas para válvulas de pneu

Válvula de retenção automática



L mm	L1 mm	€	1	009860078
18	78	12,60		

## 986PT

chave para válvulas de pneus, pré-calibrada, 0.4 Nm, retenção automática da válvula

Mecanismo de proteção da calafetagem da válvula



L mm 19 L1 mm 120 € 46,00 1 009860140

## 987

Alavanca para válvulas de pneus com protecção em borracha



L mm 310 € 25,50 1 009870001

## 987AR

alavanca para válvulas de pneus com apoio anti-riscos

- apoio em borracha e nylon para jantes de liga e de ferro
- encaixe rápido da válvula, sem necessidade de apertar

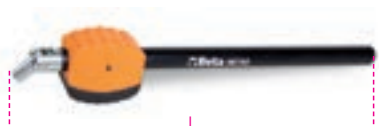

L mm 305 € 90,50 1 009870021

## 987P

alavanca para válvulas de pneus em plástico

Punho permite trabalhar com a chave no mecanismo interno da válvula



L mm 335 € 21,80 1 009870011

## 988/K4

Jogo de 4 escopros planos anti-riscos em plástico

- Particularmente adequados para remoção de vedantes adesivos em jantes de liga leve
- Arestas de corte em 3 lados para utilização mais versátil



988/K4 € 23,50 1 009880104  
A= 19-21-25-38 mm

## 989

alicate para pesos



L mm 250 € 43,00 2 009890001

## 990

pinça de pontas finas, direitas e estriadas em aço inoxidável



L mm 130 € 10,40 5 009900001

## 991

pinça de pontas finas, curvas e estriadas em aço inoxidável



L mm 130 € 12,60 5 009910001

## 992

pinça com guia, pontas finas direitas e estriadas em aço inoxidável



L mm 150 € 13,60 5 009920001

## 993

pinça com guia, pontas finas curvas e estriadas em aço inoxidável



L mm 145 € 14,70 5 009930001

## 993PL

pinça com guia, pontas finas curvas e estriadas em aço inoxidável cobertura em PVC



L mm 150 € 14,70 3 009930010

## 993G

pinça com guia, pontas finas, encurvadas e estriadas em aço inoxidável



L mm 160 € 13,10 3 009930030

## 994

pinça com pontas largas, direitas e estriadas em aço inoxidável



L mm 150 € 10,90 5 009940001

### 994PL

pinça com pontas largas, direitas e estriadas em aço inoxidável cobertura em PVC



L mm 150 € 13,10 3 009940010

### 994TF

pinça com pontas largas, direitas e estriadas em aço inoxidável anti-magnético e resistente a ácidos



L mm 150 € 17,50 3 009940020

### 996

pinça com pontas direitas espatuladas em aço inoxidável



L mm 150 € 11,60 5 009960001

### 998

pinça cruzada de pontas largas, direitas e estriadas em aço inoxidável



L mm 155 € 20,40 5 009980001

### 999

pinça com pontas chatas e arredondadas em aço inoxidável anti-magnético e resistente a ácidos



L mm 115 € 15,90 3 009990011

### 999A

pinça com pontas curtas e extra-finas em aço inoxidável anti-magnético e resistente a ácidos



L mm 120 € 14,20 3 009990015

### 999B

pinça com pontas direitas de grande resistência em aço inoxidável anti-magnético e resistente a ácidos



L mm 120 € 14,20 3 009990017

### 999C

pinça com pontas direitas e extra-finas em aço inoxidável anti-magnético e resistente a ácidos



L mm 110 € 15,30 3 009990019

### 999D

pinça com pontas extra-finas angulares em aço inoxidável anti-magnético e resistente a ácidos



L mm 115 € 17,10 3 009990021

### 999E

pinça com pontas curvas extra-finas em aço inoxidável anti-magnético e resistente a ácidos



L mm 120 € 15,30 3 009990023

### 999G

pinça de pontas direitas extra-finas com dispositivo de bloqueio em aço inoxidável anti-magnético e resistente a ácidos



L mm 140 € 15,30 3 009990027

### 999/B6

jogo de 6 pinças, resistentes a ácidos e campos magnéticos



999/B6 € 98,50 1 009990050  
999-999A-999B  
999C-999D-999E

### 1002

pinça de pontas redondas estriadas com bloqueio, em aço inoxidável



L mm 160 € 25,50 2 010020001

### 1008

alicate de pontas chatas longas, com estrias, e punhos de dupla camada de PVC



ISO 5745

L mm 160 L1 mm 51,5 € 22,60 5 010080006

### 1008BM

alicate de pontas chatas longas, com estrias, e punhos bi-material



ISO 5745

L mm 160 L1 mm 51,5 € 28,00 3 010080036



## 1009

alicates de pontas estriadas extra-longas, punhos com dupla camada de PVC anti-deslizamento



L mm	L1 mm	€	Hand	Weight
160	56,5	22,60	2	010090006

## 1009L/A

alicate para trabalhos especiais de pontas semi-redondas extra-longas, com estrias, e punhos de dupla camada de PVC



L mm	L1 mm	€	Hand	Weight
283	80	27,00	2	010090008

## 1009L/B

alicate para trabalhos especiais de pontas semi-redondas extra-longas, curvas a 45°, com estrias, e punhos de dupla camada de PVC



L mm	L1 mm	€	Hand	Weight
273	73	28,00	2	010090009

## 1009L/C

alicate para trabalhos especiais de pontas semi-redondas extra-longas, curvas a 90°, com estrias, e punhos de dupla camada de PVC



L mm	L1 mm	€	Hand	Weight
253	45	29,50	2	010090010

## 1009L/D

alicate extralongo, nariz dentado duplo giratório, pegas com revestimento duplo em PVC antiderrapante



L mm	L1 mm	€	Hand	Weight
342	71	33,00	1	010090058

## 1009L/DP

alicate curva extralongo nariz dentado duplo giratório, 45°, pegas com revestimento duplo em PVP antiderrapante



L mm	L1 mm	€	Hand	Weight
336	66	33,00	1	010090059

## 1010

alicate de pontas redondas extra-longas e punhos de dupla camada de PVC

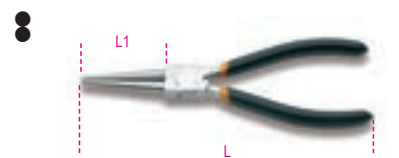

ISO 5745

L mm	L1 mm	€	Hand	Weight
160	51,5	22,60	2	010100006

## 1010BM

alicate de pontas redondas, com estrias, e punhos bi-material



ISO 5745

L mm	L1 mm	€	Hand	Weight
160	51,5	28,00	2	010100036

## 1031/S4

Jogo de 4 alicates de freios



1031/S4	€	Hand	Weight
1032 180	97,50	1	010310000
1034 170			
1036 175			
1038 175			

## 1032

alicates de freios interiores com pontas direitas e punhos em PVC



UNI 7914 DIN 5256

L mm	Ø mm	€	Hand	Weight
140x0,9	8÷12	21,50	5	010320013
140x1,3	12÷25	21,00	5	010320014
180	19÷60	22,60	5	010320017
225	40÷100	28,00	3	010320021
300	85÷200	39,50	2	010320028

## 1033

alicates de freios interiores com pontas curvas a 45° e punhos em PVC



UNI 7914 DIN 5256

L mm	Ø mm	€	Hand	Weight
140x0,9	8÷12	24,40	5	010330013
140x1,3	12÷25	23,80	5	010330014
180	19÷60	24,90	5	010330017
225	40÷100	32,00	3	010330021

## 1034

alicates de freios interiores com pontas curvas a 90° e punhos em PVC



UNI 7914 DIN 5256

L mm	Ø mm	€	Hand	Weight
130x0,9	8÷12	24,40	5	010340013
130x1,3	12÷25	23,80	5	010340014
170	19÷60	24,90	5	010340017
210	40÷100	32,00	3	010340021
290	85÷200	43,00	2	010340028

### 1034L

alicate de freios interiores com pontas curvas a 90° e punhos em PVC



L mm	∅ mm	€	🔧	📦
190	40÷100	62,50	2	010340320

### 1036

alicates de freios exteriores com pontas direitas e punhos de PVC



UNI 7915 DIN 5254

L mm	∅ mm	€	🔧	📦
140x0,9	3÷10	23,80	5	010360013
140x1,3	10÷25	22,60	5	010360014
175	19÷60	23,80	5	010360017
225	40÷100	30,00	3	010360021
300	85÷200	47,00	2	010360028

### 1037

alicates de freios exteriores com pontas curvas a 45° e punhos em PVC



UNI 7915 DIN 5254

L mm	∅ mm	€	🔧	📦
140x0,9	3÷10	26,00	5	010370013
140x1,3	10÷25	24,90	5	010370014
175	19÷60	26,00	5	010370017
225	40÷100	32,50	3	010370021

### 1038

alicates de freios exteriores com pontas curvas a 90° e punhos em PVC



UNI 7915 DIN 5254

L mm	∅ mm	€	🔧	📦
135x0,9	3÷10	26,00	5	010380013
135x1,3	10÷25	24,90	5	010380014
175	19÷60	26,00	5	010380017
220	40÷100	32,50	3	010380021
300	85÷200	50,00	2	010380028

### 1039

alicate reversível com pontas direitas para freios interiores e exteriores com punhos em PVC



L mm	∅ mm	∅ mm	€	🔧	📦
150	10÷15	6÷25	54,00	2	010390015

### 1558/C4

ferramenta para anel retentor interno e externo, operada por parafuso

Encabudo quadrado permite a aplicação de uma força elevada em ambas as condições de operação  
Pontas fornecidas:  
∅ 2.5-3-3.5 mm



∅ mm	∅ mm	€	🔧	📦
1558/C4 5,5 ÷ 77	5,5 ÷ 77	144,00	1	015580100

330x220x50 mm - 900 g

### 1044

alicate ajustável charneira sobreposta punhos com revestimento duplo em PVC antiderrapante

· novo modelo com 9 posições



ISO 8976

L mm	A max mm	L1 mm	€	🔧	📦
250	48	39	30,00	5	010440250

### 1044F

alicate ajustável charneira sobreposta punhos com revestimento em PVC

· novo modelo com 9 posições



ISO 8976

L mm	A max mm	L1 mm	€	🔧	📦
250	48	39	23,50	5	010440015

### 1046

alicate ajustável de charneira com cremalheira sobreposta e punhos em PVC

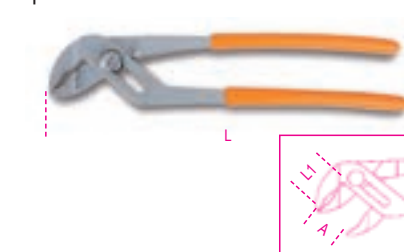

ISO 8976

L mm	A max mm	L1 mm	€	🔧	📦
240	28	33	34,00	5	010460240
400	107	55	58,00	1	010460400

### 1047

alicate ajustável de charneira fechada, com botão de bloqueio punhos com revestimento duplo em PVC antiderrapante



L mm	A max mm	L1 mm	€	🔧	📦
180	30	29	39,50	2	010470180
240	36	35	41,50	2	010470240
300	50	48	61,50	1	010470300

### 1047BM

alicate de charneira, botão de regulação, punho de 2 componentes

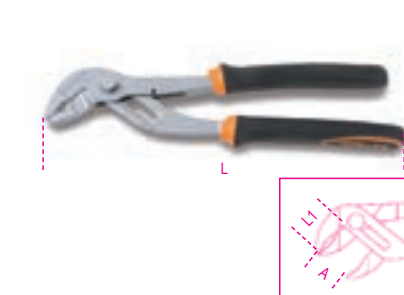

L mm	A max mm	L1 mm	€	🔧	📦
240	36	35	48,00	2	010470340

# Beta

## 1048

alicate ajustável de charneira fechada punhos revestidos a PVC

• Modelo de 9 posições

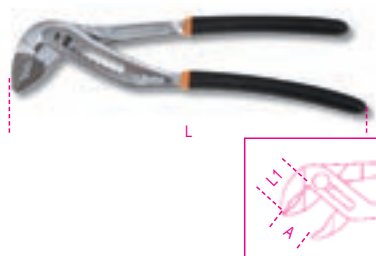

ISO 8976

L mm	A max mm	L1 mm	€	🔧	📦
175	30	29	29,00	3	010480010
250	48	39	32,00	5	010480015
300	56	47	46,50	2	010480020

## 1048BM

alicate ajustável, charneira fechada, punhos de 2 componentes

• novo modelo com 9 posições



L mm	A max mm	L1 mm	€	🔧	📦
250	48	39	41,00	3	010480215

## 1048V

alicate ajustável de charneira fechada, lacado cor de laranja

• novo modelo com 9 posições



ISO 8976

L mm	A max mm	L1 mm	€	🔧	📦
175	30	29	24,20	3	010480110
250	48	39	28,00	5	010480115
300	56	47	41,00	2	010480120

## 1050

alicate de pressão com dupla regulação



L mm	€	🔧	📦
220	70,50	2	010500022

## 1051

alicate de pressão com dupla regulação maxilas longas

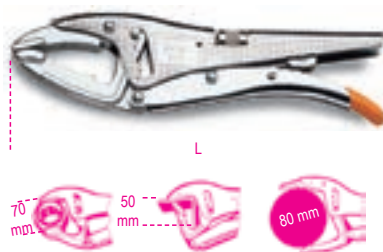

L mm	€	🔧	📦
255	77,00	2	010510025

## 1051GM

alicate de pressão com dupla regulação, maxila oscilante

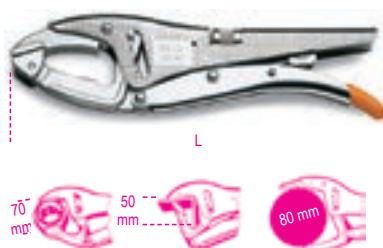

L mm	€	🔧	📦
255	82,00	2	010510250

## 1051L

alicate de pressão de grande capacidade com dupla regulação



L mm	€	🔧	📦
270	88,50	2	010510100

## 1051XL

alicate de pressão de grande capacidade com dupla regulação, mordentes extra-longos



L mm	€	🔧	📦
270	105,50	2	010510140

## 1052

alicates de pressão, maxilas côncavas



L mm	A1 max mm	€	🔧	📦
140	22	23,50	3	010520014
190	36	26,50	3	010520019
240	42	28,00	3	010520024
300	55	47,50	2	010520030

## 1053

alicates de pressão, maxila oscilante

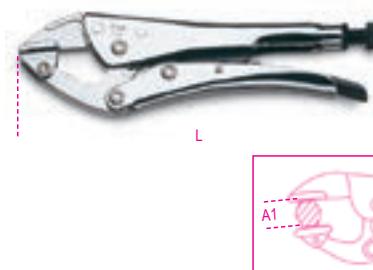

L mm	A1 max mm	€	🔧	📦
240	35	40,00	2	010530024

## 1054

alicate de pressão, maxilas direitas



L mm	A1 max mm	€	🔧	📦
235	40	34,50	2	010540022



### 1055

alicate de pressão, maxilas recurvadas

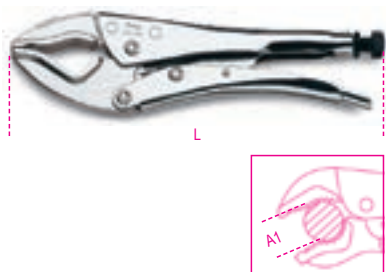

L mm	A1 max mm	€	U	U
250	60	36,00	2	010550024

### 1057A

alicate ajustável com sistema autoblocante



L mm	€	U	U
240	50,50	2	010570124

### 1058

alicates de pressão, bicos longos

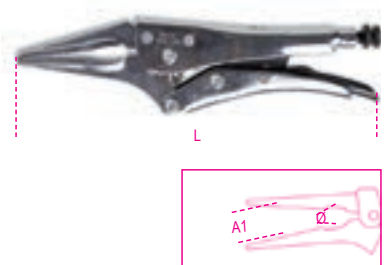

L mm	A1 max mm	Ø max mm	€	U	U
180	35	22	29,50	2	010580018
240	50	35	40,50	2	010580024
310	65	40	47,00	2	010580031

### 1060

alicate de pressão para soldadura

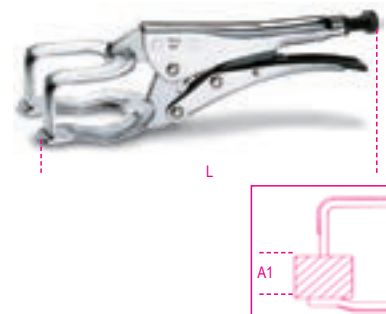

L mm	A1 max mm	€	U	U
200	50	37,50	2	010600020
280	80	48,00	2	010600028

### 1061

alicate de pressão para soldadura

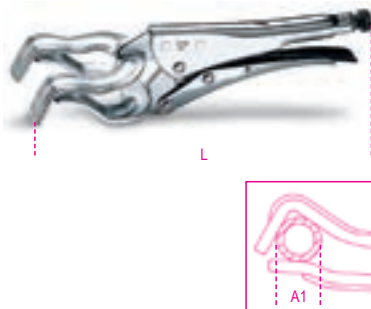

L mm	A1 max mm	€	U	U
290	80	52,50	2	010610028

### 1062

alicates de pressão pescoço de cisne

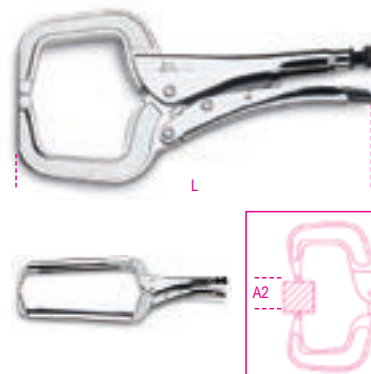

L mm	A1 max mm	€	U	U
170	50	29,00	2	010620017
290	120	39,00	2	010620029
460	250	67,50	1	010620046

### 1062AL

alicate de pressão pescoço de cisne, maxilas em alumínio

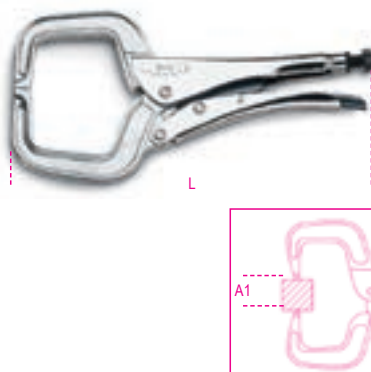

L mm	A1 max mm	€	U	U
290	104	51,00	2	010620329

### 1062GM

alicate de pressão pescoço de cisne, maxilas oscilantes

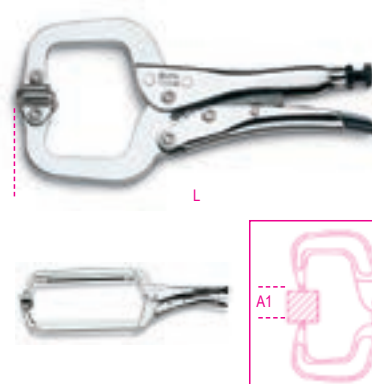

L mm	A1 max mm	€	U	U
170	45	32,50	2	010620217
290	88	45,00	2	010620229
460	260	81,00	1	010620246

### 1063

alicate de pressão para latoeiros



L mm	A1 max mm	€	U	U
200	30	50,50	2	010630020

### 1064

alicate de pressão com corrente



L mm	Ø mm	€	U	U
240	150	74,00	2	010640024

### 1065F

alicate de furar chapa

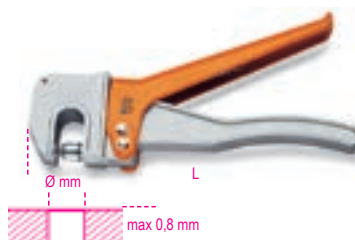

Ø mm	L mm	€	U	U
5	228	105,00	1	010650010
6	228	106,00	1	010650015

## 1065P

alicate de dobrar chapa

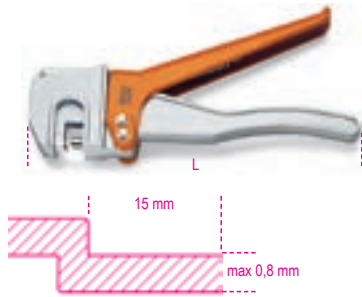

L mm	€	🔧	📦
228	108,00	1	010650020

## 1077

alicate de latoeiro com pontas largas e direitas, punhos com cobertura em PVC



L mm	A mm	L1 mm	€	🔧	📦
280	60	53	47,00	1	010770026

## 1078

alicate de latoeiro com pontas largas e curvas a 45°, punhos com cobertura em PVC



L mm	A mm	L1 mm	€	🔧	📦
280	60	77	48,00	1	010780026

## 1080D

alicate de corte diagonal raso com punhos com revestimento duplo em PVC

Para corte de plástico

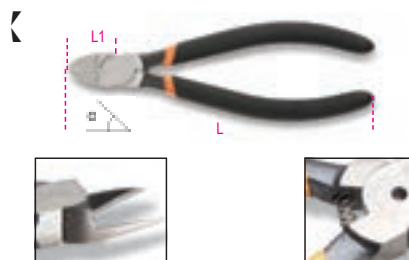

α	L mm	L1 mm	€	🔧	📦
15°	160	22	24,80	3	010800015
45°	160	22	30,00	3	010800045

## 1081

Alicate de corte, punho anti-derrapante com revestimento duplo em PVC

• Para eletrônica e trabalhos pesados em micromecânica



L mm	L1 mm	€	🔧	📦
125	16	25,00	3	010810130

## 1082

alicates de corte diagonal com punhos de dupla camada em PVC



UNI/ISO 5749

L mm	L1 mm	€	🔧	📦
140	20	22,10	5	010820004
160	22	23,80	5	010820006

## 1082BM

alicates de corte diagonal, punhos bi-material



UNI/ISO 5749

L mm	L1 mm	€	🔧	📦
140	20	27,50	3	010820034
160	22	31,00	3	010820036

## 1084

alicates de corte diagonal para serviços pesados com punhos de dupla camada em PVC



UNI/ISO 5749

L mm	L1 mm	€	🔧	📦
140	20	24,60	5	010840004
160	22	26,00	5	010840006
180	25	32,50	3	010840008
200	28	33,00	3	010840010

## 1084BM

alicates de corte diagonal para serviços pesados punhos bi-material



UNI/ISO 5749

L mm	L1 mm	€	🔧	📦
140	20	30,00	3	010840034
160	22	32,50	3	010840036
180	25	39,50	3	010840038
200	28	41,00	3	010840040

## 1088

alicates de corte frontal para serviços pesados com punhos de dupla camada em PVC

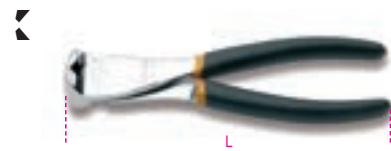

UNI/ISO 5748

L mm	L1 mm	€	🔧	📦
160	9	32,50	2	010880006
200	11	41,00	2	010880010

## 1088BM

alicates de corte frontal para serviços pesados, punhos bi-material



UNI/ISO 5748

L mm	L1 mm	€	🔧	📦
160	9	39,00	2	010880036
200	11	51,50	2	010880040



## 1092V

alicates de corte frontal articulados, serviço pesado

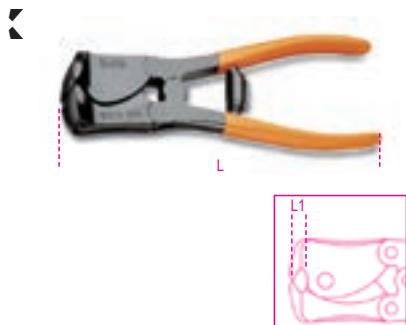

UNI/ISO 5748

L mm	L1 mm	Ø mm	€	U	g
180	8	2,0	128,00	2	010920280
200	9	2,5	135,00	2	010920310

## 1094V

alicate de corte diagonal articulados, serviço pesado



UNI/ISO 5749

L mm	L1 mm	Ø mm	€	U	g
200	23	2,5	128,00	2	010940200

## 1095N

alicate de corte diagonal



L mm	L1 mm	Ø mm	€	U	g
195	26	1,6	45,50	2	010950010

## 1096

tenazes de carpinteiro



ISO 9243

L	L1 mm	€	U	g
160	21	17,50	5	010960016
200	23	20,20	5	010960020
250	30	27,00	5	010960025

## 1098

turquês para cofragens



ISO 9242 DIN 5242

L	L1 mm	€	U	g
190	12	17,50	5	010980190
220	13	19,70	5	010980220
250	15	22,90	5	010980250
280	18	25,00	5	010980280

## 1098PL

turquês para cofragens punhos revestidos a PVC



ISO 9242 DIN 5242

L	L1 mm	€	U	g
220	13	21,30	5	010980320
250	15	24,60	5	010980350
280	18	27,00	5	010980380

## 1101

corta-parafusos



L mm	L	€	U	g
300	12	51,00	2	011010030
350	14	62,50	2	011010035
450	18	76,50	1	011010045
600	24	105,50	1	011010060
750	30	136,00	1	011010075
900	36	181,00	1	011010090

L mm	R = 80 Kgf/mm² Ø mm	R = 140 Kgf/mm² Ø mm	g
300	5	4	745
350	6	5	1043
450	7	6	1537
600	9	7	2540
750	11	8	3870
900	12	9	6170

## 1101R

lâminas de substituição para o modelo 1101



mm	1101	€	U	g
300	300	31,00	1	011010130
350	350	35,50	1	011010135
450	450	44,50	1	011010145
600	600	61,50	1	011010160
750	750	76,00	1	011010175
900	900	99,50	1	011010190

## 1102

corta-parafusos

R= 80 Kgf/mm²



L	Ø mm	€	U	g
230	4	38,00	3	011020020

## 1104

corta cabos de aço para serviços pesados, com punhos em material termoplástico



R=80 Kgf/mm²

L mm	Ø mm	€	U	g
420	12	131,00	1	011040004
600	16	192,00	1	011040006

## 1104R

lâminas de substituição para artigo 1104



mm	€	U	g
420	79,50	1	011040014
600	114,00	1	011040016

Beta

Beta

## 1105

vazador de juntas

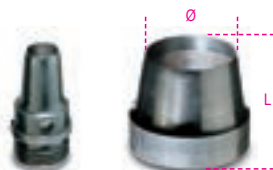

D mm	L mm	€	🔧	📦
2	27	12,90	1	011050002
3	27	12,90	1	011050003
4	27	12,90	1	011050004
5	27	12,90	1	011050005
6	27	12,90	1	011050006
7	27	12,90	1	011050007
8	27	12,90	1	011050008
9	27	12,90	1	011050009
10	27	12,90	1	011050010
12	27	15,70	1	011050012
14	27	15,70	1	011050014
16	27	15,70	1	011050016
18	27	15,70	1	011050018
20	27	15,70	1	011050020
22	32	19,90	1	011050022
24	32	19,90	1	011050024
26	32	19,90	1	011050026
28	32	19,90	1	011050028
30	32	19,90	1	011050030
32	37	25,50	1	011050032
34	37	25,50	1	011050034
36	37	25,50	1	011050036
38	37	25,50	1	011050038
40	37	25,50	1	011050040
42	42	31,50	1	011050042
44	42	31,50	1	011050044
46	42	31,50	1	011050046
48	42	31,50	1	011050048
50	42	31,50	1	011050050

## 1105T30

adaptador para punções 1105,  
3 a 30 mm



L mm	€	🔧	📦
155	139,00	1	011050201

## 1105T50

adaptador para punções 1105  
2 a 50 mm



L mm	€	🔧	📦
155	143,00	1	011050202



## 1105AD-50

adaptador para ref. 1105T50



Ø mm	€	🔧	📦
57	87,50	1	011050210

## 1105/C15T

sortido de 15 punções,  
3 a 30 mm



1105C/15T	€	🔧	📦
	298,00	1	011050251

1105	3 - 4 - 6 - 8 - 10 - 12 - 14 - 16 - 18 - 20 - 22 - 24 - 26 - 28 - 30 mm
1105T30	
📏	230x190x50 mm

## 1105/C29T

sortido de 29 punções,  
2 a 50 mm



1105C/29T	€	🔧	📦
	535,00	1	011050252

1105	2 - 3 - 4 - 5 - 6 - 7 - 8 - 9 - 10 - 12 - 14 - 16 - 18 - 20 - 22 - 24 - 26 - 28 - 30 - 32 - 34 - 36 - 38 - 40 - 42 - 44 - 46 - 48 - 50 mm
1105T50	
1105AD-50	
📏	325x280x55 mm

## 1112

tesoura modelo americano  
lâminas largas e direitas

R =  $\frac{4}{3}$  = 60 Kg/mm<sup>2</sup>

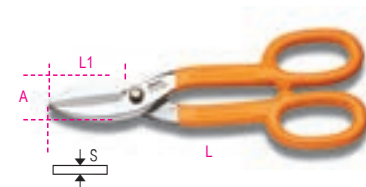

L mm	L1 mm	S mm	A mm	€	🔧	📦
200	50	0,5	26	22,40	2	011120020
250	62	0,8	33	27,00	2	011120025
300	76	1,0	37	35,50	2	011120030
375	76	1,2	44	52,50	1	011120037

## 1114

tesoura de lâminas estreitas e direitas para  
metal mole  
R = 60 Kg/mm<sup>2</sup>

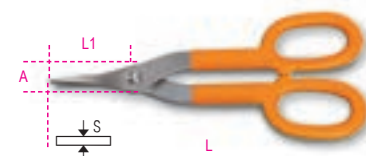

L mm	L1 mm	S mm	A mm	€	🔧	📦
250	58	0,5	15	24,00	1	011140265
350	76	1	22	32,50	1	011140340

## 1118

tesoura para cintas de embalagem

Fe = aço normal  
Inox = aço inoxidável



L mm	L1 mm	Fe S mm	Inox S mm	€	🔧	📦
310	42	1	0,8	39,50	2	011180001

## 1120A

tesoura para cortar metal

Fe = aço macio



L mm	Fe S mm	€	🔧	📦
280	1,2	64,50	1	011200101

## 1120ARL - ARG

peças de substituição para artigo 1120A



	€	🔧	📦
1120ARL	15,30	1	011200110
1120ARG	19,70	1	011200120

## 1122

tesoura articulada lâminas direitas

Inox = aço inoxidável



## 1123

tesoura articulada de lâminas curvas para contornos a direita

Inox = aço inoxidável



## 1124

tesoura articulada de lâminas curvas para contornos a esquerda

Inox = aço inoxidável



## 1125

tesoura articulada para cortes rectilíneos e contornos a direita

Inox = aço inoxidável

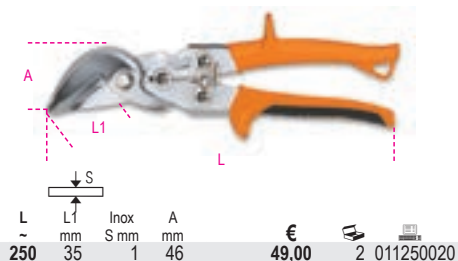

## 1126

tesoura articulada para cortes rectilíneos e contornos a esquerda

Inox = aço inoxidável

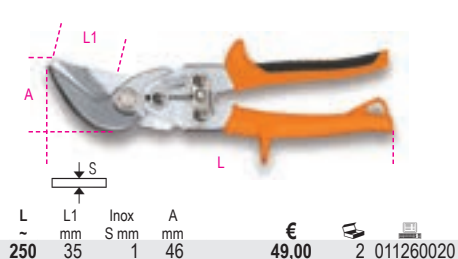

## 1122 - 1125MOL



Art.	Art.	€	Unid.	Art.
1122 MOL	1122 - 1124	1,35	1	011220010
1123 MOL	1123	1,20	1	011230010
1125 MOL	1125 - 1126	1,20	1	011250040

## 1127

tesouras para técnico de telefones lâminas direitas



## 1128BAX

Tesoura de electricista com perfis de escareação graduados, lâminas em aço inox com revestimento DLC

Gumes de corte duplo: pino excêntrico especial permite que as lâminas se movimentem a todo o comprimento, aumentando a eficiência de corte.

Concebida para alargar furos em plástico, de 13 mm a 25 mm.

Revestimento DLC (diamond-like carbon) é um revestimento inovador à base de carbono: a elevada dureza e baixo atrito resultam da combinação de carbono, sob a forma de grafite, e diamante.

- Elevada dureza da superfície da lâmina (resistência à abrasão e desgaste)
- Baixa fricção (suavidade e antiaderência)
- Pino excêntrico especial
- Punhos de grandes dimensões com ranhura para corte de cabos e cravagem de terminais
- Com caixa em plástico articulada
- Patentada



L	L1	€	Unid.	Art.
mm	mm			
150	50	28,50	5	011280088

## 1128BCX

tesoura de electricista, lâminas direitas em aço inoxidável, com micro-dentado, ranhura para corte de cabos e alicata para cravagem de terminais

cravagem de terminais: 1÷4 mm<sup>2</sup> em estojo de plástico



L	L1	€	Unid.	Art.
mm	mm			
155	55	26,00	5	011280080

## 1128BMX

tesoura para electricistas, lâminas direitas em aço inoxidável, com micro-dentes



L	L1	€	Unid.	Art.
mm	mm			
145	54	15,70	5	011280050

## 1128BSX

tesoura de electricista com perfis de escareação graduados, em caixa



L	L1	€	Unid.	Art.
mm	mm			
145	50	27,00	5	011280060

## 1128BM

tesouras de lâminas direitas para electricistas



L	L1	€	Unid.	Art.
mm	mm			
145	50	13,90	5	011280000





### 1129BM

tesouras de lâminas curvas para electricistas



L	L1	€	🔧	📦
mm	mm			
145	44	14,90	5	011290000

### 1130BMX

tesoura multiusos, lâminas direitas em aço inox, com micro-dentado



L	L1	€	🔧	📦
mm	mm			
190	58	25,50	1	011300001

### 1131CK

tesoura para Kevlar® e fibra óptica



L	L1	€	🔧	📦
mm	mm			
203	75	72,00	1	011310001

### 1132

corta-cabos para cabos isolados de cobre e alumínio com punhos de dupla camada em PVC



UNI 8791

L	mm	mm²	€	🔧	📦
170	14	50	43,00	2	011320107
230	18	95	53,00	2	011320113

### 1132BM

corta-cabos para cabos isolados de cobre e alumínio com punhos bi-material



UNI 8791

L	mm	mm²	€	🔧	📦
170	14	50	53,50	2	011320137
230	18	95	66,00	2	011320143

### 1133

corta-cabos para cabos em cobre, flexível

até 325 mm²



L	mm	mm²	€	🔧	📦
600	32	300	150,00	1	011330001

### 1133RL

lâminas de substituição para artigo 1133



1133RL	€	🔧	📦
	112,00	1	011330011

### 1134

corta-cabos com roquete



L	mm	mm	mm²	€	🔧	📦
260	35	400	434,00	1	011340032	

### 1134RL

lâmina de substituição para o modelo 1134



1134RL	€	🔧	📦
	199,00	1	011340132

### 1134A

corta-cabos com roquete



L	mm	mm	mm²	€	🔧	📦
240	45	500	660,00	1	011340045	

### 1134A/RL

lâmina de substituição para modelo 1134A



1134A/RL	€	🔧	📦
	306,00	1	011340145

### 1136

corta cabos de aço

Ø 5 mm cabos com R ≤ 160 kg/mm²  
Ø 4 mm cabos em aço macio



L	mm	€	🔧	📦
165		51,00	2	011360001

### 1142BM

alicate para descarnar fio punhos bi-material



UNI 7923

L	mm	mm²	mm	€	🔧	📦
160	0,5+6	0-2,8	35,50	3	011420036	

### 1143

alicates para descarnar fio com dispositivo de corte



L	mm	mm²	mm	€	🔧	📦
165	1+6	1-3,2	71,50	1	011430001	

### 1143R

lâminas de substituição para artigo 1143

1143R	€	🔧	📦
	18,00	1	011430011



## 1144D

alicate para descarnar cabo



L mm	mm <sup>2</sup>	mm	€	U	U
170	4,5÷240	2,5-18	84,00	1	011440010

## 1144D/RG

gancho de substituição para artigo 1144D



1144D/RG	€ 27,50	U 1	U 011440012
----------	---------	-----	-------------

## 1144D/RL

laminas de substituição para artigo 1144D

1144D/RL	€ 43,50	U 1	U 011440011
----------	---------	-----	-------------

## 1144G

alicate para descarnar cabo

com lâmina ajustável para cortes longitudinais e transversais



L mm	mm <sup>2</sup>	mm	€	U	U
140	6÷75	2,8-12	47,00	1	011440004

## 1144G/RL

lâmina sobresselente para artigo 1144G



1144G/RL	€ 9,75	U 1	U 011440005
----------	--------	-----	-------------

## 1148A

alicates para descarnar fio,  
com ajuste e dispositivo de corte

10 mm<sup>2</sup> (8 AWG) fios flexíveis  
1,5 mm<sup>2</sup> (16 AWG) fios rígidos



L mm	mm <sup>2</sup>	mm	€	U	U
190	0,02÷10	0-4	144,00	1	011480100

## 1148A/R

lâminas para artigo 1148A



1148A/R	€ 62,00	U 1	U 011480102
---------	---------	-----	-------------

## 1148B

alicates para descarnar fio,  
com ajuste e dispositivo de corte

10 mm<sup>2</sup> (8 AWG) fios flexíveis  
1,5 mm<sup>2</sup> (16 AWG) fios rígidos



L mm	mm <sup>2</sup>	mm	€	U	U
190	4÷16	2-5	168,00	1	011480200

## 1148B/R

lâminas de substituição  
para artigo 1148B



1148B/R	€ 76,50	U 1	U 011480202
---------	---------	-----	-------------

## 1149F

alicate frontal de descarnar fio  
com lâmina de corte, com fecho automático

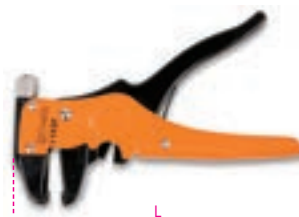

L mm	mm <sup>2</sup>	€	U	U
175	0,2 ÷ 6	15,30	1	011490010

## 1150

alicates universais em cromado brilhante  
com punhos de dupla camada de PVC



ISO 5746

L mm	L1 mm	mm	€	U	U
160	37	1,6	19,60	5	011500006
180	41	1,8	21,30	5	011500008
200	45	2,0	23,50	5	011500010
220	50	2,0	25,50	2	011500012

## 1150BM

alicates universais em cromado brilhante  
com punhos bi-material



ISO 5746

L mm	L1 mm	mm	€	U	U
160	37	1,6	24,60	3	011500036
180	41	1,8	27,00	3	011500038
200	45	2,0	30,00	3	011500040
220	50	2,0	32,50	2	011500042

## 1153

alicates reguláveis com duas posições  
e punhos em PVC



UNI ISO 9343

L mm	L1 mm	€	U	U
200	34	22,40	2	011530120

## 1162

alicates de pontas chatas  
extra-longas com estrias  
e punhos de dupla camada em PVC



ISO 5745

L mm	L1 mm	mm	€	U	U
160	58	1,6	22,90	5	011620006
200	86	1,6	26,00	5	011620010

## 1162BM

alicates de pontas chatas extra-longas  
com estrias punhos bi-material



ISO 5745

L mm	L1 mm	mm	€	U	U
160	58	1,6	28,00	3	011620036
200	86	1,6	32,50	3	011620040

# Beta

## 1164

alicates de pontas curvas chatas com estrias, extra-longas, e punhos de dupla camada de PVC



ISO 5745

L	L1	mm	€	5	011640006
160	54	1,6	25,00	5	011640006
200	76	1,6	28,00	5	011640010

## 1164BM

alicates de pontas curvas chatas com estrias, extra-longas, e punhos de dupla camada de PVC



ISO 5745

L	L1	mm	€	3	011640036
160	54	1,6	31,50	3	011640036
200	76	1,6	35,00	3	011640040

## 1166

alicates de pontas semi-redondas com estrias, extra-longas, e punhos de dupla camada de PVC



ISO 5745

L	L1	mm	€	5	011660006
160	56	1,6	22,90	5	011660006
200	76	1,6	26,00	5	011660010

## 1166BM

alicates de pontas semi-redondas com estrias, extra-longas, e punhos bi-material



ISO 5745

L	L1	mm	€	3	011660036
160	56	1,6	28,00	3	011660036
200	76	1,6	32,50	3	011660040

## 1168

alicates de pontas curvas semi-redondas com estrias, extra-longas, e punhos de dupla camada de PVC



ISO 5745

L	L1	mm	€	5	011680006
160	54	1,6	25,00	5	011680006
200	76	1,6	28,00	5	011680010

## 1168BM

alicates de pontas curvas semi-redondas com estrias, extra-longas, e punhos bi-material



ISO 5745

L	L1	mm	€	3	011680036
160	54	1,6	31,50	3	011680036
200	70	1,6	35,00	3	011680040

## 1171BM

alicate de pontas chatas curtas, brunido punhos bi-material



ISO 9655

L	L1	A	B	€	2	011710101
125	18	12	8	39,00	2	011710101

## 1172BM

alicate de pontas chatas longas, brunido punhos bi-material

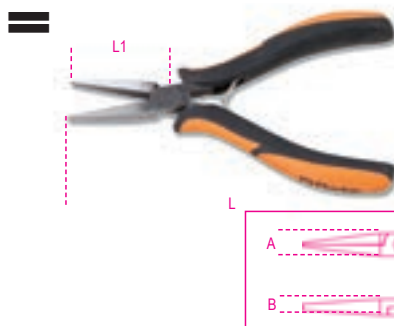

ISO 9655

L	L1	A	B	€	2	011720101
140	40	12	8	39,00	2	011720101

## 1172BM/P

alicate de pontas chatas curvas, brunido punhos bi-material

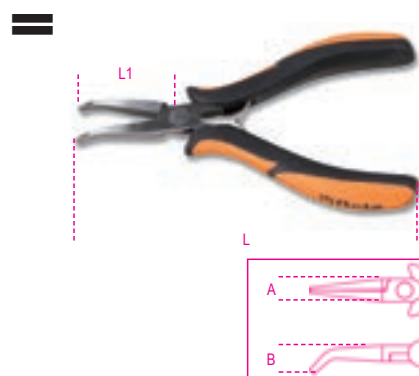

L	L1	A	B	€	2	011720102
140	38	12	13	44,00	2	011720102

## 1173BM

alicate de pontas redondas curtas, punhos bi-material



ISO 9655

L	L1	A	B	€	2	011730101
125	22	12	8	39,00	2	011730101

## 1175BM

alicate de pontas semi-redondas curtas, brunido punhos bi-material

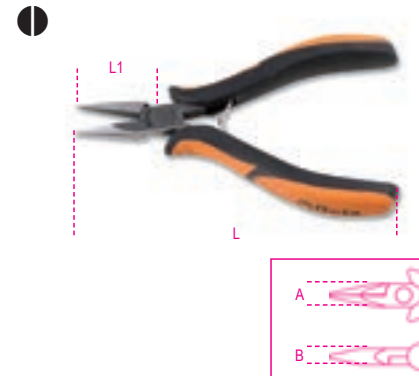

ISO 9655

L	L1	A	B	€	2	011750101
140	29	12	8	39,00	2	011750101

### 1177BM

alicate de pontas semi-redondas longas, brunido  
punhos bi-material

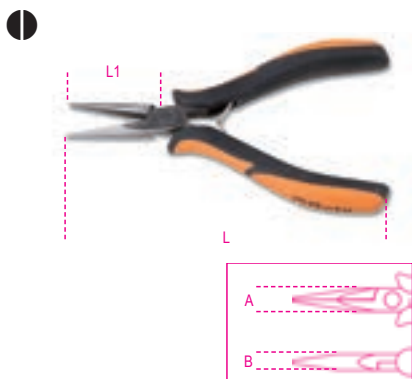

ISO 9655

L	L1	A	B	€	Q	U
140	38	12	8	39,00	2	011770101

### 1177BM/Z

alicate de pontas semi-redondas longas com estrias  
punhos bi-material



ISO 9655

L	L1	A	B	€	Q	U
140	39	12	8	44,00	2	011770113

### 1178BM

alicate de pontas semi redondas longas, brunido  
punhos bi-material

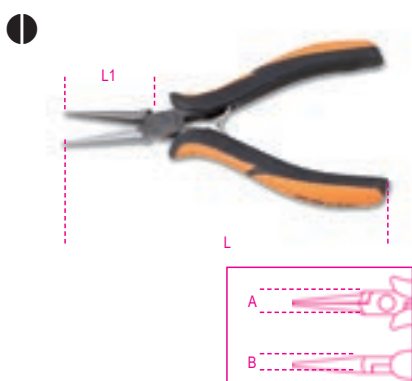

ISO 9655

L	L1	A	B	€	Q	U
140	37	12	8	44,00	2	011780101

### 1178BM/P

alicate de pontas semi-redondas longas curvas, brunido  
punhos bi-material

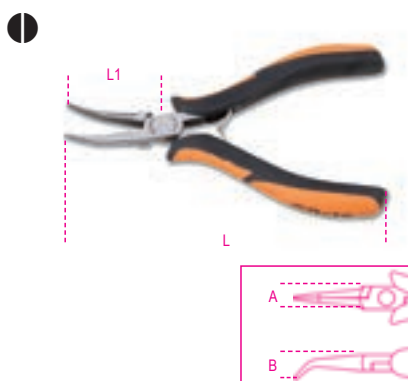

L	L1	A	B	€	Q	U
140	36,5	12	12	44,00	2	011780102

**Alicate de corte diagonal, semi-raso pontas finas, punhos bi-material**  
Para trabalhos mais fortes, ver item 1081

### 1182BM

alicate de corte diagonal, semi-raso pontas finas  
punhos bi-material



ISO 9654

L	L1	A	Cu	€	Q	U
120	11	10	1	44,00	2	011820101

### 1183BM

alicate de corte diagonal, semi-raso pontas redondas  
punhos bi-material



ISO 9654

L	L1	A	Cu	€	Q	U
120	11	10	1	44,00	2	011830101

### 1184BM

alicate de corte diagonal, raso pontas redondas  
punhos bi-material



ISO 9654

L	L1	A	Cu	€	Q	U
120	11	10	1	45,00	2	011840101
130	13	12,5	1,25	45,00	2	011840102

### 1185BM

alicate de corte diagonal, raso pontas finas  
punhos bi-material



ISO 9654

L	L1	A	Cu	€	Q	U
120	11	10	1	44,00	2	011850101
130	13	12,5	1,25	44,00	2	011850102



## 1186BM

alicate de corte diagonal, raso,  
pontas finas e estriadas  
punhos bi-material



ISO 9654

L mm	L1 mm	A mm	Cu mm	€	🔧	📦
120	11	10	1	44,00	2	011860101
130	13	12,5	1,25	47,00	2	011860102

## 1188BM

alicate de corte diagonal normal  
punhos bi-material



ISO 9654

L mm	L1 mm	A mm	Cu mm	€	🔧	📦
125	12	12	1,25	44,00	2	011880101
130	17	15	2	44,00	2	011880102

## 1190BM

alicate de corte frontal, semi raso  
punhos bi-material



ISO 9654

L mm	L1 mm	A mm	Cu mm	€	🔧	📦
120	12	12	1,25	44,00	2	011900113

## 1191BM

alicate de corte frontal oblíquo, raso  
punhos bi-material



ISO 9654

L mm	L1 mm	A mm	Cu mm	€	🔧	📦
130	8	12	0,8	44,00	2	011910101

## 1191BM/L

alicate de corte frontal oblíquo longo,  
punhos bi-material



ISO 9654

L mm	L1 mm	A mm	Cu mm	€	🔧	📦
130	18	12	1	45,00	2	011910110

## 1191R/5-M

kit de molas de substituição para alicates e  
pinças  
para componentes eletrônicos, 5 pares  
(artigos: 1171...1191)

Artigo	€	🔧	📦
1191R/5-M	8,20	1	011910995

## 1200MS

magnetizador/desmagnetizador

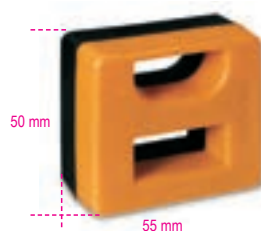

Artigo	€	🔧	📦
1200MS	14,20	5	012000000

## 1201

chaves para parafusos  
de perfil de fenda



ISO 2380

SxAxL mm	L1 mm	Ø mm	€	🔧	📦
0,4x2,5x50	146	2,5	3,40	5	012010003
0,4x2,5x75	166	2,5	3,50	5	012010006
0,5x3x75	171	3,0	3,60	5	012010009
0,5x3x100	196	3,0	3,90	5	012010012
0,6x3,5x75	171	3,5	3,95	5	012010018
0,6x3,5x100	196	3,5	4,00	5	012010021
0,8x4x100	196	4,0	4,05	5	012010030
0,8x4x125	221	4,0	4,30	5	012010033
0,8x4x150	246	4,0	4,65	5	012010036
1,0x5,5x100	209	5,0	5,00	5	012010039
1,0x5,5x125	234	5,0	5,20	5	012010040
1,0x5,5x150	259	5,0	5,40	5	012010042
1,2x6,5x100	220	6,0	5,85	5	012010048
1,2x6,5x125	234	6,0	6,05	5	012010050
1,2x6,5x150	270	6,0	6,20	5	012010051
1,2x8x150	282	8,0	8,10	3	012010057
1,2x8x200	332	8,0	8,65	3	012010060
1,6x10x200	332	9,5	9,95	3	012010066



Artigo	€	🔧	📦
1201/S6	34,50	1	012010206

0,5x3x75-0,6x3,5x100  
0,8x4x100-1,0x5,5x100  
1,2x8x150-1,6x10x200 mm

## 1201N

chave de perfil de fenda de série extra curta



ISO 2380

SxAxL mm	L1 mm	Ø mm	€	🔧	📦
0,8x4x30	86,5	4	4,80	3	012010103
1,2x6,5x30	86,5	6	5,10	3	012010106

## 1201DZ

chaves para parafusos de perfil Dzus®



Artigo	€	🔧	📦
1201DZ	12,00	2	012010501

## 1202

chaves para parafusos de perfil Phillips®



UNI/ISO 8764

PHxDxL mm	L1 mm	€	🔧	📦
0x3x60	156	3,50	5	012020003
0x3x100	200	3,95	5	012020006
1x4,5x80	189	4,60	5	012020009
1x4,5x120	229	5,00	5	012020012
2x6x100	220	6,15	5	012020018
2x6x150	270	6,65	5	012020021
3x8x150	282	8,30	3	012020024
4x9,5x200	332	11,30	3	012020027



	€	🔧	📦
1202/S4	23,50	1	012020204

PH0x3x60-PH1x4,5x120  
PH2x6x150-PH3x8x150 mm

## 1202N

chave de perfil Phillips(R) de série extra curta



UNI/ISO 8764

PHxDxL mm	L1 mm	€	🔧	📦
1x4,5x30	86,5	4,80	3	012020103
2x6x30	86,5	5,15	3	012020106

## 1202L

chaves de parafusos para perfil Phillips®, série longa



UNI/ISO 8764-1

PHxDxL mm	L1 mm	€	🔧	📦
0x3x300	400	6,25	3	012020303
1x4,5x300	400	6,80	3	012020305
1x4,5x400	508	8,30	3	012020306
2x6x400	519	9,60	3	012020309

## 1203/D

jogo de chaves de parafusos



	€	🔧	📦
1203/D5	26,50	1	012030001

1201	0,6x3,5x100-1,0x5,5x150
1202	1,2x6,5x150 mm PH1x4,5x80-PH2x6x100 mm

	€	🔧	📦
1203/D7	33,00	1	012030007

1201	0,5x3x75-0,8x4x100
1202	1,0x5,5x100-1,2x6,5x150 mm PH0x3x60-PH1x4,5x80 PH2x6x100 mm

	€	🔧	📦
1203/D8	42,00	1	012030008

1201	0,5x3x75-0,8x4x125
1202	1,0x5,5x150-1,2x6,5x150 mm PH0x3x60-PH1x4,5x80 PH2x6x100-PH3x8x150 mm

	€	🔧	📦
1203/D10N	46,50	1	012030019

1201	0,4x2,5x50-0,5x3x75-0,8x4x100-1,0x5,5x150-1,2x6,5x150 mm
1201N	0,8x4x30 mm
1202	PH0x3x60-PH1x4,5x80- PH2x6x100 mm
1202N	PH1x4,5x30 mm

	€	🔧	📦
1203/D10	53,00	1	012030010

1201	0,4x2,5x50-0,5x3x75
	0,8x4x100-1,0x5,5x100
	1,2x6,5x150-1,2x8x150 mm
1202	PH0x3x60-PH1x4,5x80 PH2x6x100-PH3x8x150 mm

	€	🔧	📦
1203/D6	27,00	1	012030006

1202	PH1x4,5x80-PH2x6x100 mm
1204	0,4x2,5x60-0,5x3x100
	0,8x4x100-1,0x5x125 mm

	€	🔧	📦
1203/D5PZ	26,00	1	012030003

1201	0,5x3x75-0,8x4x125
	1,0x5,5x150 mm
1209PZ	PZ1x4,5x80-PZ2x6x100 mm

## 1203/S



	€	🔧	📦
1203/S8	37,00	1	012030009

1201	2,5x50-3x75-4x100-5,5x125-6,5x150 mm
1202	PH0x3x60-PH1x4,5x80- PH2x6x100 mm

	€	🔧	📦
1203/S10	53,50	1	012030021

1201	0,4x2,5x50-0,5x3x75
	0,8x4x125-1,0x5,5x150
	1,2x6,5x150-1,2x8x150 mm
1202	PH0x3x60-PH1x4,5x80 PH2x6x100-PH3x8x150 mm



## 1204

chaves para parafusos de perfil de fenda sem cabeça



SxDxL mm	L1 mm	€	🔧	📦
0,4x2,5x60	156	3,45	5	012040003
0,6x3x75	175	3,55	5	012040006
0,5x3x100	196	3,60	5	012040009
0,8x4x100	196	4,05	5	012040012
0,8x4x125	233	4,40	5	012040015
1x5x125	234	4,95	5	012040018
1x5x150	258	5,45	5	012040021
1,2x6,5x150	270	5,90	5	012040024

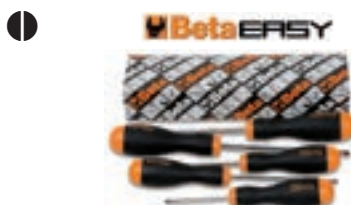

	€	🔧	📦
1204/S5	22,00	1	012040205

0,4x2,5x60-0,5x3x100  
0,8x4x100-1x5x125  
1,2x6,5x150 mm

## 1204L

chaves para parafusos de perfil de fenda sem cabeça, série longa



SxLxL mm	L1 mm	€	🔧	📦
0,5x2,5x200	300	5,05	3	012040303
0,5x3x300	400	6,00	3	012040306
0,8x4x400	508	7,55	3	012040309
1x5x400	508	8,10	3	012040315
1,2x6,5x400	519	10,20	3	012040318

## 1205ES

chaves sextavadas com punho



mm	L mm	L1 mm	€	🔧	📦
1,5	100	200	4,40	3	012050315
2	100	200	4,55	3	012050320
2,5	100	200	4,60	3	012050325
3	100	200	4,70	3	012050330
4	100	208	5,25	3	012050340
5	100	219	6,45	3	012050350
6	125	244	6,55	3	012050360
8	150	277	8,85	2	012050380

## 1207TX

chaves para parafusos de perfil Torx®



	L mm	L1 mm	Ø mm	€	🔧	📦
T5	50	150	3	5,15	5	012070005
T6	60	156	4	5,85	5	012070006
T7	60	156	4	5,90	5	012070007
T8	60	156	4	6,00	5	012070008
T9	60	156	4	6,25	5	012070009
T10	80	189	5	6,80	5	012070010
T15	80	189	5	6,90	5	012070015
T20	100	209	5	7,00	5	012070020
T25	100	209	5	7,20	5	012070025
T27	100	220	6	7,55	5	012070027
T30	100	220	6	7,85	5	012070030
T40	130	262	7	9,05	2	012070040
T45	130	262	8	10,10	2	012070045



1207TX/D7  
T6-T8-T10-T15  
T20-T25-T30

€ 47,50 1 012070207

## 1208RTX

chaves para parafusos de perfil Tamper Resistant Torx®



Ø	L mm	L1 mm	Ø mm	€	🔧	📦
T9	60	156	4	6,35	5	012080009
T10	80	189	5	7,00	5	012080010
T15	80	189	5	7,35	5	012080015
T20	100	209	5	7,45	5	012080020
T25	100	209	5	7,55	5	012080025
T27	100	220	6	8,20	5	012080027
T30	100	220	6	8,55	5	012080030
T40	130	262	7	10,10	2	012080040



1208RTX/D7  
T9-T10-T15-T20  
T25-T27-T30

€ 52,50 1 012080207

## 1209PZ

chaves de punho para parafusos de perfil Pozidriv® - Supadriv®



UNI/ISO 8764

PZ	L mm	L1 mm	€	🔧	📦
0	60	156	4,30	5	012090000
1	80	189	5,45	5	012090003
2	100	220	7,10	5	012090006
3	150	282	10,70	3	012090009
4	200	327	11,80	3	012090012



1209PZ/S4  
PZ0-PZ1-PZ2-PZ3

€ 27,50 1 012090204

## 1209N/PZ

chaves com punho para parafusos de perfil Pozidriv®-Supadriv®, série extra-curta



PZ	L mm	L1 mm	€	🔧	📦
1	30	87	4,90	3	012090103
2	30	87	5,10	3	012090106



## 1229LP

chaves de relógio para parafusos de perfil de fenda sem cabeça

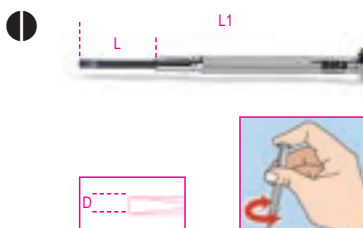

D mm	L mm	L1 mm	€	🔧	📦
1,0	17	75	3,75	5	012290210
1,2	21	85	3,75	5	012290212
1,4	21	89	3,75	5	012290214
1,8	23	94	3,75	5	012290218
2,0	23	98	3,75	5	012290220
2,4	26	103	3,75	5	012290224
3,0	28	108	4,50	5	012290230



1229LP/A6  
1,2-1,4-1,8-2-2,4-3 mm

€ 22,40 1 012290300

## 1229PH

chaves de relógio para parafusos de perfil Phillips®

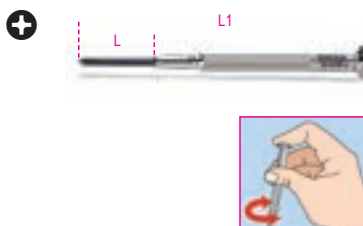

PH	L mm	L1 mm	€	🔧	📦
0	26	102	4,15	5	012290250
1	29	107	4,40	5	012290251

## 1229LPH/A6

jogo de 6 chaves de relógio 1229LP-1229PH



1229LPH/A6  
1229LP 1,4-2,0-2,4-3 mm  
1229PH PH0-PH1

€ 22,40 1 012290310

## 1236B

chave de parafusos angular para parafusos de perfil de fenda

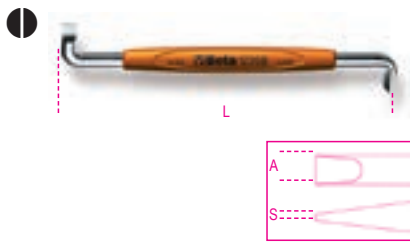

UNI 7079 DIN 5200

SxA mm	L mm	€	🔧	📦
0,8x4	100	6,35	5	012360201
1x5,5	125	7,45	5	012360202
1,2x8	150	9,20	5	012360204

## 1238B

chave de parafusos angular para parafusos de perfil Phillips®



UNI 7083 DIN 5208

PH	L mm	€	🔧	📦
1-2	125	7,45	5	012380201
3-4	200	12,50	5	012380203

## 1241

chave de parafusos com ponta de aço para parafusos de perfil de fenda



SxAxL mm	L1 mm	€	🔧	📦
1x5,5x100	202	9,75	5	012410039
1,2x6,5x125	240	10,90	5	012410050
1,2x8x150	268	13,30	3	012410057
1,6x10x200	325	16,90	2	012410066

## 1242

chave de parafusos com ponta de aço para parafusos com perfil Phillips®



UNI/ISO 8764

PHxDxL mm	L1 mm	€	🔧	📦
1x4,5x100	202	9,60	5	012420209
2x6x100	215	11,40	5	012420218
3x8x150	268	14,80	3	012420221
4x11x200	325	19,10	2	012420224

## 1243/D7

Jogo de 7 chaves de parafusos com ponta de aço



1243/D7 € 87,00 1 012430017

1241	1x5,5x100-1,2x6,5x125
1242	1,2x8x150-1,6x10x200 mm PH1x4,5x100-PH2x6x100 PH3x8x150 mm

## 1250

chaves de fenda com guia prensili



SxDxL mm	L1 mm	€	🔧	📦
0,5x3x125	190	14,20	5	012500030
0,6x4x125	225	15,30	5	012500040
0,7x5x150	255	18,00	5	012500050

## 1251

chaves para parafusos de perfil Phillips® com guia prensili



PHxDxL mm	L1 mm	€	🔧	📦
0x4x125	225	15,90	5	012510000
1x5x150	255	18,70	5	012510010
2x6x175	280	21,50	5	012510020

## 1252/S5



1252/S5 € 88,00 1 012520001

1250	0,5x3x125-0,6x4x125 0,7x5x150 mm
1251	PH1x5x150-PH2x6x175 mm

## 1253

busca-pólos 150/250V

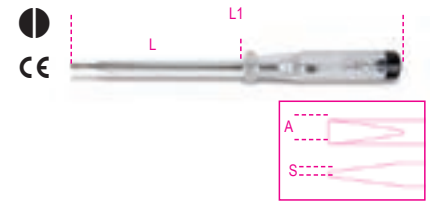

SxAxL mm	L1 mm	€	🔧	📦
0,5x3,5x100	190	8,30	5	012530001

## 1253A

busca-pólos 125/250V, duplo isolamento

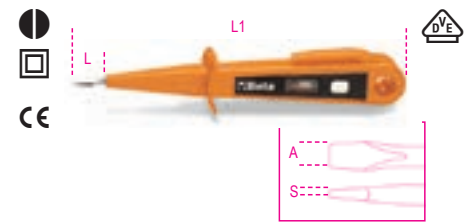

SxAxL mm	L1 mm	€	🔧	📦
0,5x3x15	150	6,00	5	012530010

## 1254

busca-pólos 6/24V

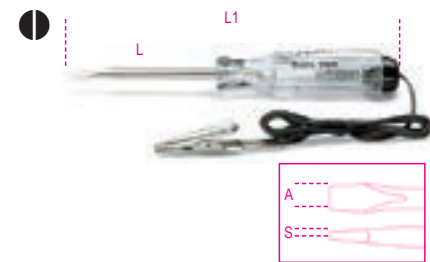

SxAxL mm	L1 mm	€	🔧	📦
0,5x3x44	123	8,95	5	012540001

## 1256/C36-2

punho para micro-chaves com 36 pontas intermutáveis de 4 mm e extensão magnética



1256/C36-2	€	🔧	📦
	60,00	1	012560100

🔧 1256TX	T3 - T4 - T5 - T6 - T7 T8 - T9 - T10 - T15
🔧 1256RTX	T6 - T7 - T8 - T9 - T10
🔧 1256LP	0,8 - 1,2 - 1,5 - 1,8 - 2 - 2,5 3 - 3,5 - 4 mm
🔧 1256PE	0,7 - 0,9 - 1,3 - 1,5 - 2 mm
🔧 1256PH	PH000 - PH00 - PH0 - PH1
🔧 1256PZ	PZ000 - PZ00 - PZ0 - PZ1

🔧 1256/20
🔧 1256/30

📦 130x60x35 mm - 📦 200 g



## 1256LP

bits 4 mm  
para parafusos ranhurados

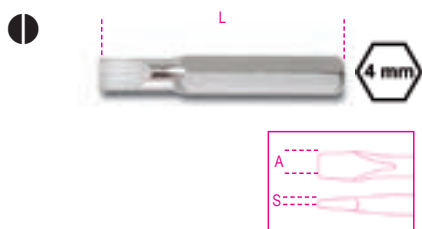

SxA mm	L mm	€	🔧	📦
0.25x0.8	27	1,15	5	012560001
0.25x1.2	27	1,15	5	012560002
0.3x1.5	27	1,15	5	012560003
0.35x1.8	27	1,15	5	012560004
0.4x2.0	27	1,15	5	012560005
0.4x2.5	27	1,15	5	012560006
0.5x3.0	27	1,15	5	012560007
0.6x3.5	27	1,15	5	012560008
0.8x4.0	27	1,15	5	012560009

## 1256PH

bits 4 mm  
para parafusos Phillips®



PH	L mm	€	🔧	📦
000	27	1,15	5	012560011
00	27	1,15	5	012560012
0	27	1,15	5	012560013
1	27	1,15	5	012560014

## 1256PZ

bits 4 mm  
para parafusos de cabeça ranhurada Pozidriv®  
- Supradriv®



PZ	L mm	€	🔧	📦
000	27	1,15	5	012560061
00	27	1,15	5	012560062
0	27	1,15	5	012560063
1	27	1,15	5	012560064

## 1256PE

bits 4 mm  
para parafusos sextavados



mm	L mm	€	🔧	📦
0.7	27	1,15	5	012560021
0.9	27	1,15	5	012560022
1.3	27	1,15	5	012560023
1.5	27	1,15	5	012560024
2.0	27	1,15	5	012560025

## 1256TX

bits 4 mm  
para parafusos Torx®



T	L mm	€	🔧	📦
T3	27	1,20	5	012560041
T4	27	1,20	5	012560042
T5	27	1,20	5	012560043
T6	27	1,20	5	012560044
T7	27	1,20	5	012560045
T8	27	1,20	5	012560046
T9	27	1,20	5	012560047
T10	27	1,20	5	012560048
T15	27	1,20	5	012560049

## 1256RTX

bits 4 mm  
para parafusos invioláveis "Tamper Resistant  
Torx®"



T	L mm	€	🔧	📦
T6	27	1,45	5	012560051
T7	27	1,45	5	012560052
T8	27	1,45	5	012560053
T9	27	1,45	5	012560054
T10	27	1,45	5	012560055

## 1256/20

extensão sextavada, 4 mm



1256/20	€	🔧	📦
	7,10	5	012560092

## 1256/30

porta-bits 4 mm com punho



L mm	€	🔧	📦
110	8,65	2	012560097

## 1257LP

micro-chaves para parafusos  
de perfil de fenda



SxD mm	L mm	€	🔧	📦
0,2x1,2	60	4,65	5	012570012
0,25x1,5	60	4,65	5	012570015
0,3x1,8	60	4,65	5	012570018
0,4x2	60	4,65	5	012570020
0,4x2,5	60	4,65	5	012570024
0,5x3	60	4,65	5	012570030
0,6x3,5	60	4,65	5	012570035
0,8x4	60	4,65	5	012570040

## 1257PH

micro-chaves para parafusos  
de perfil Phillips®



PH	L mm	€	🔧	📦
00	60	4,65	5	012570060
0	60	4,65	5	012570063
1	60	4,65	5	012570066

## 1257LPH/S8

Jogo de 8 micro-chaves (refa.  
1257LP, 1257PH) em caixa



1257LPH/S8	€	🔧	📦
	59,00	1	012570210

1257PH	PH00-PH0-PH1
1257LP	0,4x2-0,4x2,5-0,5x3 0,6x3,5-0,8x4 mm

## 1257ES

micro-chaves com ponta  
macho hexagonal



mm	L mm	€	🔧	📦
0,9	60	5,05	5	012570045
1,3	60	5,05	5	012570046
1,5	60	5,05	5	012570047
2	60	5,05	5	012570048
2,5	60	5,05	5	012570049
3	60	5,05	5	012570050

## 1257ESB/S8



<b>1257ESB/S8</b>	€ 65,50	1	012570230
1257ES	0,9-1,3-1,5-2-2,5-3 mm		
1257BE	4-5 mm		

## 1257TX

micro-chaves para parafusos de perfil Torx®



Ø	L mm	€	U	U
T5	60	5,35	5	012570075
T6	60	5,35	5	012570076
T7	60	5,35	5	012570077
T8	60	5,35	5	012570078
T9	60	5,35	5	012570079
T10	60	5,35	5	012570080
T15	60	5,35	5	012570081
T20	60	5,35	5	012570082



<b>1257TX/S8</b>	€ 64,50	1	012570220
T5-T6-T7-T8			
T9-T10-T15-T20			

## 1257BE

micro-chave de fenda para parafusos macho sextavados



Ø mm	L mm	€	U	U
3,2	60	6,80	5	012570085
4	60	6,80	5	012570086
5	60	6,80	5	012570087
5,5	60	6,80	5	012570088

## 1260

chaves para parafusos de perfil de fenda

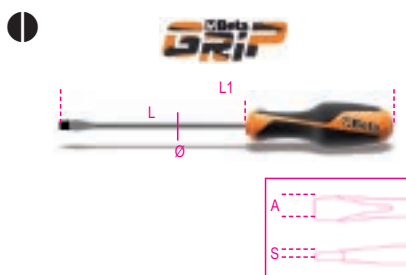

ISO 2380

SxAxL mm	L1 mm	Ø mm	€	U	U
0,4x2,5x50	150	2,5	4,80	5	012600003
0,4x2,5x75	175	2,5	4,95	5	012600006
0,5x3x75	175	3,0	5,05	5	012600009
0,5x3x100	200	3,0	5,25	5	012600012
0,6x3,5x75	175	3,5	5,40	5	012600018
0,6x3,5x100	200	3,5	5,45	5	012600021
0,8x4x100	208	4,0	5,90	5	012600030
0,8x4x125	233	4,0	6,15	5	012600033
0,8x4x150	258	4,0	6,35	5	012600036
1x5,5x100	208	5,0	6,80	5	012600039
1x5,5x125	233	5,0	6,90	5	012600040
1x5,5x150	258	5,0	7,55	5	012600042
1,2x6,5x100	219	6,0	8,20	5	012600048
1,2x6,5x125	244	6,0	8,40	5	012600050
1,2x6,5x150	269	6,0	8,75	5	012600051
1,2x8x150	277	8,0	10,80	3	012600057
1,2x8x200	327	8,0	11,30	3	012600060
1,6x10x200	327	9,5	13,60	3	012600066
2x12x250	377	10	16,00	3	012600069
2x14x250	377	10	16,90	2	012600073



<b>1260/S6</b>	€ 44,00	1	012600306
0,4x2,5x75-0,5x3x75-0,8x4x125			
1x5,5x150-1,2x6,5x150-1,2x8x200 mm			

## 1260N

chaves para parafusos de perfil de fenda, série extra curta



ISO 2380

SxAxL mm	L1 mm	Ø mm	€	U	U
0,8x4x30	87	4	6,35	5	012600103
1,2x6,5x30	87	6	6,80	5	012600106



## 1260E

chaves para parafusos de perfil de fenda com sextavado auxiliar



ISO 2380

SxAxL mm	L1 mm	Ø mm	€	U	U
1,2x6,5x150	269	6,0	11,50	3	012600156
1,2x8x175	301	8,0	14,20	3	012600157
1,6x10x200	327	9,5	16,70	2	012600159
2x12x250	377	9,5	19,10	2	012600162

## 1262

chaves para parafusos de perfil Phillips(R)



UNI/ISO 8764

PhxDxL mm	L1 mm	€	U	U
0x3x60	160	5,05	5	012620003
0x3x100	200	5,40	5	012620006
1x4,5x80	188	6,65	5	012620009
1x4,5x120	228	7,20	5	012620012
2x6x100	219	8,20	5	012620018
2x6x150	269	8,95	5	012620021
3x8x150	277	12,10	3	012620024
4x10x200	327	15,30	3	012620027



<b>1262/S4</b>	€ 32,50	1	012620304
PH0x3x60-PH1x4,5x80			
PH2x6x100-PH3x8x150 mm			

## 1262N

chaves para parafusos de perfil Phillips®, série extra curta



UNI/ISO 8764

PhxDxL mm	L1 mm	€	U	U
1x4,5x30	87	6,35	5	012620103
2x6x30	87	6,90	5	012620106

## 1262E

chaves para parafusos de perfil Phillips® com sextavado auxiliar



UNI/ISO 8764

PHxDxL mm	L1 mm	€	🔧	📦
2x6x150	269	11,50	3	012620153
3x8x175	302	14,20	3	012620156
4x10x200	327	16,80	2	012620159

## 1262L

chaves para parafusos de perfil Phillips®, série longa



UNI/ISO 8764-1

PHxDxL mm	L1 mm	€	🔧	📦
0x3x300	400	8,95	3	012620203
1x4,5x300	400	10,40	3	012620205
1x4,5x400	508	12,30	3	012620206
2x6x400	519	15,90	3	012620209

## 1263/D...

jogo de chaves de parafusos



🔧	📦	€
1263/D6	1	41,50

1260	PH1x4,5x80 PH2x6x100 mm
1264	0,5x2,5x60-0,6x3x100 0,8x4x125-1x5x125 mm

🔧	📦	€
1263/D7	1	43,50

1260	PH1x4,5x80 PH2x6x100 mm
1264	0,5x2,5x60-0,6x3x100 0,8x4x125-1x5x125 mm

🔧	📦	€
1263/D7PZ	1	49,50

1260	0,5x3x75-0,8x4x100 1x5,5x150-1,2x6,5x150 mm
1269PZ	PZ0 - PZ1 - PZ2

🔧	📦	€
1263/D8	1	51,50

1260	0,4x2,5x50-0,5x3x75 0,8x4x100-1x5,5x125 1,2x6,5x150 mm
1262	PH0x3x60-PH1x4,5x80 PH2x6x100 mm

🔧	📦	€
1263/D10	1	65,50

1260	0,5x3x75-0,6x3,5x100 0,8x4x125-1x5,5x150 1,2x6,5x150 mm
1260N	0,8x4x30
1262	PH0x3x60-PH1x4,5x80 PH2x6x100 mm
1262N	PH1x4,5x30

## 1263/S12

jogo de 12 chaves de parafusos



🔧	📦	€
1263/S12	1	94,00

1260	0,4x2,5x50-0,5x3x75 0,6x3,5x100-0,8x4x125 1x5,5x125-1,2x6,5x150 1,2x8x200-1,6x10x200 mm
1262	PH0x3x60-PH1x4,5x80 PH2x6x100-PH3x8x150 mm

## 1264

jogo de chaves para parafusos de perfil de fenda sem cabeça



SxDxL mm	L1 mm	€	🔧	📦
0,5x2,5x60	160	4,90	5	012640003
0,6x3x75	175	5,15	5	012640006
0,6x3x100	200	5,25	5	012640009
0,8x4x100	208	6,15	5	012640012
0,8x4x125	233	6,25	5	012640015
1x5x125	233	6,90	5	012640018
1x5x150	258	7,55	5	012640021
1,2x6,5x150	269	8,85	5	012640024



🔧	📦	€
1264/S5	1	32,00

0,5x2,5x60-0,6x3x75 0,8x4x100-1x5x125-1,2x6,5x150 mm
---

## 1264L

jogo de chaves para parafusos de perfil de fenda sem cabeça, série longa



SxDxL mm	L1 mm	€	🔧	📦
0,5x2,5x200	300	7,20	3	012640203
0,6x3x300	400	8,30	3	012640206
0,8x4x400	508	10,90	3	012640209
1x5x400	508	12,30	3	012640215
1,2x6,5x400	519	14,80	3	012640218

## 1265ES

chaves hexagonais com punhos



mm	L mm	L1 mm	€	🔧	📦
1,5	100	200	5,80	3	012650015
2	100	200	6,00	3	012650020
2,5	100	200	6,25	3	012650025
3	100	200	6,55	3	012650030
4	100	208	7,20	3	012650040
5	100	219	8,40	3	012650050
6	125	244	9,50	3	012650060
8	150	277	12,40	2	012650080



🔧	📦	€
1265ES/S8	1	62,50

1,5-2-2,5-3-4-5-6-8 mm

## 1266BP

chaves hexagonais de extremidade esférica com punhos



mm	L mm	L1 mm	€	🔧	📦
2	100	200	6,45	3	012660020
2,5	100	200	6,65	3	012660025
3	125	225	7,00	3	012660030
4	125	233	7,75	3	012660040
5	120	239	8,95	3	012660050
6	140	259	10,30	3	012660060
8	160	287	13,00	2	012660080
10	160	287	15,30	2	012660100



**1266BP/S8** € 75,50 1 012660308  
2-2,5-3-4-5-6-8-10 mm

### 1267TX

chaves para parafusos de perfil Torx®, com punhos



Ø	L mm	L1 mm	Ø mm	€	U	U
T5	50	150	3	7,20	5	012670005
T6	50	150	3	7,55	5	012670006
T7	50	150	3	7,75	5	012670007
T8	60	160	3	8,10	5	012670008
T9	60	167	4	8,55	5	012670009
T10	80	188	4	8,85	5	012670010
T15	80	188	4	9,40	5	012670015
T20	100	208	4,5	9,85	5	012670020
T25	100	208	5	10,50	5	012670025
T27	115	234	6	11,10	5	012670027
T30	115	234	6	11,40	5	012670030
T40	130	257	7	13,00	2	012670040
T45	130	257	8	14,20	2	012670045



**1267TX/D7** € 65,50 1 012670307  
T6-T8-T10-T15  
T20-T25-T30



**1267TX/S13** € 127,00 1 012670312  
T5-T6-T7-T8-T9  
T10-T15-T20-T25  
T27-T30-T40-T45

### 1268RTX

chaves para parafusos de perfil Tamper Resistant Torx®, com punhos



Ø	L mm	L1 mm	Ø mm	€	U	U
T9	60	167	4,0	9,20	3	012680009
T10	80	188	4,0	9,50	3	012680010
T15	80	188	4,0	9,85	3	012680015
T20	100	208	4,5	10,50	3	012680020
T25	100	208	5,0	10,80	3	012680025
T27	115	234	6,0	11,60	3	012680027
T30	115	234	6,0	11,90	3	012680030
T40	130	257	7,0	13,50	2	012680040



**1268RTX/S8** € 87,00 1 012680307  
T9-T10-T15-T20  
T25-T27-T30-T40

### 1269PZ

chaves para parafusos de perfil Pozidriv®-Supadriv®



UNI/ISO 8764

PZ	L mm	L1 mm	€	U	U
0	60	160	5,70	5	012690000
1	80	188	7,45	5	012690001
2	100	219	9,05	5	012690002
3	150	277	12,90	3	012690003
4	200	327	16,60	3	012690004



**1269PZ/S4** € 35,00 1 012690304  
PZ0-PZ1-PZ2-PZ3

### 1269N/PZ

chaves para parafusos de perfil Pozidriv®-Supadriv®, série extra curta



UNI/ISO 8764

PZ	L mm	L1 mm	€	U	U
1	30	87	6,35	5	012690011
2	30	87	6,90	5	012690012

### 1281BG

punho para chave de parafusos de lâmina intermutável



L mm 118, mm 10, € 10,70 5 012810280

### 1281PM

porta-pontas magnético de fixação rápida



L mm 165, € 18,60 5 012810292

### 1281PB

porta-chaves de caixa com quadra macho 1/4"



L mm 175, € 14,70 5 012810293

### 1281LP

lâmina reversível intermutável para parafusos de perfil de fenda



**1281LP/1** € 9,40 5 012810302  
0,8x4-1,2x6,5 mm  
**1281LP/2** € 9,40 5 012810304  
1x5,5-1,2x6,5 mm

## 1281PH

lâmina reversível intermutável  
para parafusos de perfil Phillips®



PH	€	5	012810310
1-2	9,40		
2-3	9,40		012810312

## 1281LPH

lâmina reversível intermutável  
para parafusos de perfil Phillips® e fenda



	€	5	012810321
1281LPH/1 PH0-0,8x4 mm	9,40		
1281LPH/2 PH1-1x5,5 mm	9,40		012810322
1281LPH/3 PH2-1,2x6,5 mm	9,40		012810323

## 1281PZ

lâmina reversível intermutável  
para parafusos de perfil Pozidriv®-Supadriv®



PZ	€	5	012810330
1-2	9,40		
2-3	9,40		012810332

## 1281PE

lâmina reversível intermutável  
hexagonal macho, esférica



mm	€	5	012810342
2,5	9,30		
3	9,30		012810343
4	9,30		012810344
5	9,30		012810345
6	9,30		012810346

## 1281TX

lâmina reversível intermutável  
para parafusos de perfil Torx®



	€	5	012810349
1281TX/1 T6-T8	10,10		
1281TX/2 T7-T9	10,10		012810350
1281TX/3 T10-T15	10,10		012810351
1281TX/4 T20-T25	10,10		012810352
1281TX/5 T30-T40	10,10		012810353

## 1281RTX

lâmina reversível intermutável  
para parafusos de perfil Tamper Resistant  
Torx®



	€	5	012810361
1281RTX/3 T10-T15	10,30		
1281RTX/4 T20-T25	10,30		012810362
1281RTX/5 T30-T40	10,30		012810363

## 1281BG/A9

jogo 9 chaves reversíveis  
e 1 acessório em bolsa



1281BG/A9	€	1	012810520
-----------	---	---	-----------

1281BG	
1281LPH/1	PH0-0,8x4 mm
1281LPH/2	PH1-1x5,5 mm
1281LPH/3	PH2-1,2x6,5 mm
1281PZ/1	PZ1-PZ2
1281PE	2,5 mm
1281PE	3 mm
1281PE	4 mm
1281PE	5 mm
1281PE	6 mm

## 1281BG-TX/A8

jogo 8 chaves reversíveis  
e 1 acessório em bolsa



1281BG-TX/A8	€	1	012810530
--------------	---	---	-----------

1281BG	
1281LPH/1	PH0-0,8x4 mm
1281LPH/2	PH1-1x5,5 mm
1281LPH/3	PH2-1,2x6,5 mm
1281TX/1	T6-T8
1281TX/2	T7-T9
1281TX/3	T10-T15
1281TX/4	T20-T25
1281TX/5	T30-T40

## 1281BG/B28A

jogo de 16 lâminas reversíveis intermutáveis,  
9 chaves de caixa 1/4", 2 acessórios  
e 1 punho, em bolsa



1281BG/B28A	€	1	012810510
-------------	---	---	-----------

900	4 - 4,5 - 5 - 5,5 6 - 7 - 8 - 9 - 10 mm
1281BG	
1281PB	1/4"
900/25	
1281LP/1	0,8x4 - 1,2x6,5 mm
1281LP/2	1,0x5,5 - 1,2x6,5 mm
1281PH/1	PH1 - PH2
1281PH/2	PH2 - PH3
1281PZ/1	PZ1 - PZ2
1281PZ/2	PZ2 - PZ3
1281PE	2,5 - 3 - 4 - 5 - 6 mm
1281TX/1	T6 - T8
1281TX/2	T7 - T9
1281RTX/3	T10 - T15
1281RTX/4	T20 - T25
1281RTX/5	T30 - T40

1281/BV	€	1	012810501
---------	---	---	-----------

## 1290

chaves para parafusos  
de perfil de fenda



ISO 2380

SxAL mm	L1 mm	Ø mm	€	5	012900003
0,4x2,5x50	146	2,5	6,00		
0,4x2,5x75	171	2,5	6,15		012900006
0,5x3x75	171	3,0	6,25		012900009
0,5x3x100	196	3,0	6,55		012900012
0,6x3,5x75	171	3,5	7,20		012900018
0,6x3,5x100	196	3,5	7,35		012900021
0,8x4x100	196	4,0	7,35		012900030
0,8x4x125	221	4,0	7,65		012900033
0,8x4x150	246	4,0	8,00		012900036
1x5,5x100	209	5,0	8,20		012900039
1x5,5x150	259	5,0	9,30		012900042
1,2x6,5x100	220	6,0	10,30		012900048
1,2x6,5x150	270	6,0	10,90		012900051
1,2x8x150	282	7,0	13,70		012900057
1,2x8x200	332	7,0	14,40		012900060
1,6x10x200	332	8,0	17,10		012900066
2x12x250	382	10	22,90		012900069

# Beta INOX

STAINLESS STEEL

240

## 1290/S

jogo de chaves de parafusos



	€	🔧	📄
<b>1290/S5</b>	47,50	1	012900305
1290	0,5x3x75-0,8x4x100 - 1x5,5x150 1,2x6,5x150 - 1,2x8x150 mm		

	€	🔧	📄
<b>1290/S9X</b>	89,50	1	012900319
1290	0,4x2,5x75 - 0,5x3,5x100 0,8x4x125 - 1x5,5x150 1,2x6,5x150 - 1,2x8x200 1,6x10x200 mm		
1290N	0,8x4x30 - 1,2x6,5x30 mm		

## 1290N

chaves série curta para parafusos de perfil de fenda



ISO 2380

SxAxL mm	L1 mm	Ø mm	€	🔧	📄
0,8x4x30	86	4	7,85	5	012900103
1,2x6,5x30	86	6	8,75	5	012900106

## 1292

chaves para parafusos de perfil Phillips®



UNI/ISO 8764

PHxDxL mm	L1 mm	€	🔧	📄
0x3x60	156	5,80	10	012920003
0x3x100	196	6,45	5	012920006
1x4,5x80	189	7,85	10	012920009
1x4,5x120	229	8,65	10	012920012
2x6x100	220	10,40	10	012920018
2x6x150	270	11,40	10	012920021
3x8x150	282	14,30	3	012920024
4x10x200	332	19,90	3	012920027



	€	🔧	📄
<b>1292/S4</b>	38,50	1	012920304
	PH0x3x60-PH1x4,5x80 PH2x6x100-PH3x8x150 mm		

## 1292N

chaves série curta para parafusos de perfil Phillips®



UNI/ISO 8764

PHxDxL mm	L1 mm	€	🔧	📄
1x4,5x30	86	7,45	5	012920103
2x6x30	86	8,10	5	012920106

## 1292L

chaves série longa para parafusos de perfil Phillips®

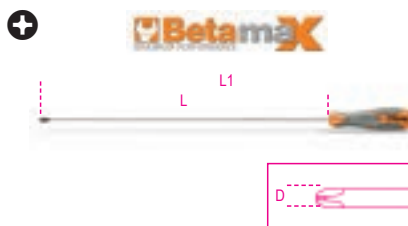

UNI/ISO 8764-1

PHxDxL mm	L1 mm	€	🔧	📄
0x3x300	396	12,60	3	012920203
1x4,5x400	509	15,50	3	012920206
2x6x400	520	19,30	3	012920209

# Beta INOX

STAINLESS STEEL

240

## 1293/D...

jogo de chaves de parafusos



	€	🔧	📄
<b>1293/D6</b>	51,50	1	012930401
1290	0,6x3,5x75-1x5,5x150 1,2x6,5x150 mm		
1292	PH0x3x60 - PH1x4,5x80 PH2x6x100 mm		

	€	🔧	📄
<b>1293/D8</b>	71,50	1	012930403
1290	0,5x3x75-0,8x4x100 1x5,5x150-1,2x6,5x150 1,2x8x150 mm		
1292	PH0x3x60 - PH1x4,5x80 PH2x6x100 mm		

## 1293/S...

jogo de chaves de parafusos



	€	🔧	📄
<b>1293/S8</b>	64,00	1	012930208
1290	2,5x50-3x75-4x100-5,5x150 6,5x150 mm		
1292	PH0x3x60-PH1x4,5x80 PH2x6x100 mm		

	€	🔧	📄
<b>1293/S10</b>	101,50	1	012930201
1290	0,4x2,5x50 - 0,6x3,5x100 1x5,5x100-1,2x6,5x150 1,2x8x150-1,6x10x200 mm		
1292	PH0x3x60 - PH1x4,5x80 PH2x6x100-PH3x8x150 mm		

	€	🔧	📄
<b>1293/S12</b>	111,00	1	012930203
1290	0,5x3x75-0,8x4x125 1x5,5x150-1,2x6,5x150 1,2x8x200 mm		
1290N	0,8x4x30 mm		
1292	PH0x3x60 - PH1x4,5x80 PH2x6x100-PH3x8x150 mm		
1292N	PH1x4,5x30-PH2x6x30 mm		

	€	🔧	📄
<b>1293/S7</b>	52,00	1	012930207
1292	PH0x3x60 - PH1x4,5x80 PH2x6x100 mm		
1294	0,5x2,5x60-0,6x3x75 0,8x4x100-1x5x125 mm		

# Beta

## 1293ES

chaves hexagonal macho com punho



mm	L mm	L1 mm	Ø mm	€	U	U
2	100	196	3	8,00	5	012930001
2,5	100	196	4	8,00	5	012930002
3	100	196	4	8,30	5	012930003
4	100	196	5	9,40	5	012930004
5	100	209	6	10,30	5	012930005
6	125	245	7	11,80	5	012930006
8	150	282	10	15,30	2	012930008



1293ES/S7 € 71,00 1 012930057  
2-2,5-3-4-5-6-8 mm

## 1293BP

chaves hexagonal macho com extremidade esférica e punho



mm	L mm	L1 mm	€	U	U
2	100	196	8,10	5	012930501
2,5	100	196	8,10	5	012930502
3	100	196	8,40	5	012930503
4	100	196	9,40	5	012930506
5	100	209	10,30	5	012930509
6	125	245	12,00	5	012930512
8	150	282	16,20	2	012930515



1293BP/S7 € 72,50 1 012930558  
2-2,5-3-4-5-6-8 mm

## 1294

chaves para parafusos de perfil de fenda sem cabeça



SxDxL mm	L1 mm	€	U	U
0,5x2,5x60	156	5,60	5	012940003
0,6x3x75	171	5,80	5	012940006
0,6x3x100	196	6,00	5	012940009
0,8x4x100	196	7,35	5	012940012
0,8x4x150	246	9,75	5	012940015
1x5x125	234	8,95	5	012940018
1,2x6,5x150	282	10,70	5	012940027



1294/S5 € 39,00 1 012940305  
0,5x2,5x60-0,6x3x100  
0,8x4x100-1x5x125  
1,2x6,5x150 mm

## 1294L

chaves série longa para parafusos de perfil de fenda sem cabeça

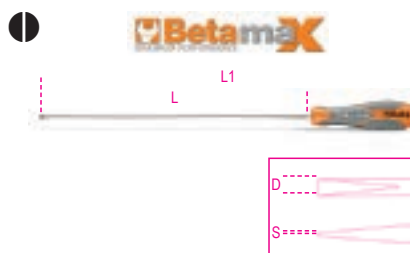

SxDxL mm	L1 mm	€	U	U
0,6x3x300	396	11,90	3	012940206
0,8x4x400	496	14,20	3	012940209
1x5x400	509	17,30	3	012940215
1,2x6,5x400	532	19,30	3	012940218

## 1295

desandador de percussão



1295/S12 L mm € 53,50 1 012950001  
130

## 1295/C14

desandador de percussão com 14 pontas e 1 porta pontas



1295/C14 € 127,00 1 012950108

866LP	1,2x6,5 - 1,6x10 mm
866PH	PH2 - PH3
866PZ	PZ2 - PZ3
866PE	5 - 6 mm
866TX	T27 - T30 - T40 - T45 - T50 - T55
895/6	□ 1/2 - ○ 5/16
1295	■ 1/2

170x100x35 mm - 1,3 kg

## 1297TX

chaves com punho para parafusos de perfil Torx®



Ø mm	L mm	L1 mm	Ø mm	€	U	U
T6	50	146	3,0	10,60	5	012970006
T7	50	146	3,0	10,80	5	012970007
T8	60	156	3,0	10,90	5	012970008
T9	60	169	4,0	11,50	5	012970009
T10	80	189	4,0	12,00	5	012970010
T15	80	189	4,0	12,10	5	012970015
T20	100	209	4,5	12,60	5	012970020
T25	100	209	5,0	13,00	5	012970025
T27	115	235	6,0	13,30	5	012970027
T30	115	235	6,0	14,00	5	012970030
T40	130	262	7,0	15,30	2	012970040
T45	130	262	8,0	17,50	2	012970045



1297TX/S12 € 154,00 1 012970312  
T6-T7-T8-T9-T10  
T15-T20-T25-T27  
T30-T40-T45

# Beta

**Betamax**

1297TX/D6 € 77,00 1 012970409  
T10-T15-T20  
T25-T27-T30

**1298RTX**

chaves com punho para parafusos  
de perfil Tamper Resistant Torx®

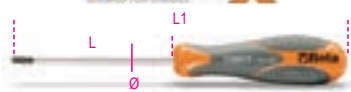
**Betamax**

⊕	L mm	L1 mm	∅ mm	€	1	012980009
T9	60	169	4,0	12,60	5	012980009
T10	80	189	4,0	12,80	5	012980010
T15	80	189	4,0	13,60	5	012980015
T20	100	209	4,0	13,70	5	012980020
T25	100	209	4,5	14,00	5	012980025
T27	115	235	5,5	14,80	5	012980027
T30	115	235	6,0	15,30	5	012980030
T40	130	262	7,0	16,30	2	012980040

**Betamax**

1298RTX/S8 € 113,00 1 012980308  
T9-T10-T15-T20  
T25-T27-T30-T40

**1299PZ**

chaves para parafusos  
de perfil Pozidriv® - Supadriv®

**Betamax**

UNI/ISO 8764

⊕	PZ	L mm	L1 mm	€	1	012990000
	0	60	156	8,00	5	012990000
	1	80	189	9,50	5	012990003
	2	100	220	13,30	5	012990006
	3	150	282	19,30	2	012990009
	4	200	332	27,00	2	012990012

**Betamax**

1299PZ/S6 € 70,00 1 012990306  
1299PZ PZ0-PZ1-PZ2-PZ3  
1299N/PZ PZ1-PZ2

**1299N/PZ**

chaves série curta para parafusos  
de perfil Pozidriv® - Supadriv®

**Betamax**

UNI/ISO 8764

⊕	PZ	L mm	L1 mm	€	5	012990021
	1	30	86	9,40	5	012990021
	2	30	86	10,40	5	012990024

**1302**

encontrador duplo com punho  
com almofada convexa e pena



770 g € 82,00 1 013020001

**1303**

encontrador tipo virgula



1350 g € 62,50 1 013030001

**1304**

encontrador tipo palmilha com entalhe



875 g € 80,00 1 013040001

**1305**

encontrador curvo



1190 g € 49,00 1 013050001

**1305Z**

encontrador curvo serrilhado

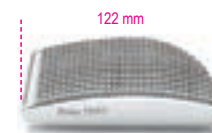

1065 g € 58,50 1 013050002

**1306**

encontrador tipo tacão



1040 g € 47,00 1 013060001

**1307**

encontrador rectangular

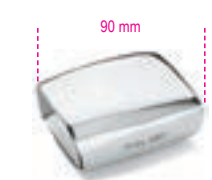

1100 g € 92,00 1 013070001

**1308**

encontrador oval



1100 g € 85,50 1 013080001



**1309**

encontrador de pena dupla



g 460 € 54,50 1 013090001

**1310**

encontrador tipo trilho



g 1225 € 52,50 1 013100001

**1312**

encontrador tipo bigorna



g 1220 € 112,00 1 013120001

**1313**

encontrador tipo tampão



g 990 € 76,50 1 013130001

**1314**

encontrador redondo duplo com almofadas convexa e plana



g 760 € 50,50 1 013140001

**1326**

colher estreita simples



g 560 € 45,50 1 013260001

**1327**

colher larga simples



g 1075 € 64,00 1 013270001

**1328**

colher côncava simples



g 935 € 57,50 1 013280001

**1329**

colher dupla com mesas largas



g 1800 € 174,00 1 013290001

**1330**

colher dupla pescoço de cisne com mesas largas



g 2125 € 185,00 1 013300001

**1331**

colher curva com face em couro



g 1100 € 102,50 1 013310001

**1335BM**

lima de bancada com punho plástico



g 500 € 31,00 2 013350010

**1337/S5**

jogo de 5 espátulas para reparação auto, em aço inoxidável

Tipo Japonês  
(25-50-75-100-125 mm)



L mm € 11,50 1 013370015

**1338A - 1338B**

armações flexíveis com lima de chapeiro



	mm / 1"	L mm	€		
1338A	9	360	86,50	2	013380001
1338B	12	360	89,50	2	013380002

**1338**

armação para limas para refª. 1338R



g 1338 € 47,50 2 013380003

### 1338R9 - 1338R12

limas de substituição  
para ref<sup>as</sup>. 1338A-B



1338R9	9	€ 39,00	2	013380004
1338R12	12	€ 42,00	2	013380005

### 1342

talhadeira extra-chata com lâmina direita



L mm	€			
235	26,00	5	013420001	

### 1342PM

talhadeira chata com cortante direito  
com punho de protecção

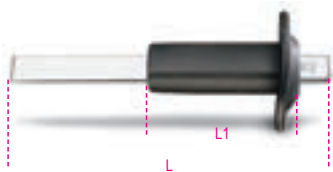

L mm	L1 mm	€		
235	118	37,50	2	013420002

### 1342PMR

punho de protecção para ref<sup>a</sup>. 1342



1342PMR	€ 10,90	1	013420003
---------	---------	---	-----------

### 1343

talhadeira chata com lâmina oblíqua



L mm	€			
200	28,00	5	013430001	



### 1344

Apalpa folgas para bate-chapas ,  
par, 10-lâminas, com ventosa de  
apoio

Indicado para :  
- colocação de vidros traseiros  
- controlo de distância entre painéis



1344	€ 33,00	1	013440010
------	---------	---	-----------

### 1345

martelo com cabeça convexa redonda  
e pena, larga cabo em madeira



1345	€ 39,50	2	013450010
------	---------	---	-----------

### 1351

martelo com cabeça plana redonda  
e pena pontiaguda, cabo em madeira



1351	€ 40,50	2	013510010
------	---------	---	-----------

### 1353

martelo com cabeças redondas plana  
e convexa, cabo em madeira



1353	€ 41,50	2	013530010
------	---------	---	-----------

### 1357Z/45

martelo com cabeça redonda  
serrilhada e quadrada plana,  
cabo em madeira



1357Z/45	€ 63,50	2	013570045
----------	---------	---	-----------

### 1359T

martelo com cabeça plana redonda  
e pena horizontal, cabo em madeira



1359 T	€ 39,50	2	013590010
--------	---------	---	-----------

### 1360/K6

Martelo de alumínio com batente plano, com  
pinos de plástico intermutáveis e punção

Fornecido com :  
- 4 pinos de plástico  
- 1 punção, ajustável  
em dois comprimentos diferentes, aplicável ao martelo



L mm	Ø mm	€		
320	34	76,50	1	013600006

### 1362

Refletor de mossas  
com ventosa

Permite detetar mesmo  
as imperfeições mais pequenas



LxH mm	€			
240 x 200	70,50	1	013620010	

## 1365/K13

kit chapeiro com bomba hidráulica 10 t e acessórios em trolley

O kit inclui:

- bomba hidráulica, 10 t, com tubo 1,5 m comp., união 1/2"
- pistão
- pinça; capacidade: 500 kg
- placa base, 150x90 mm
- base em L, 50x50 mm
- punção 4 pontos
- punção redonda, Ø 50 mm
- punção cunha, 43 mm
- extensão 240-mm
- extensão 450-mm
- extensão 475-mm
- cabeça em borracha
- união macho-macho para instalar acessórios



1365/K13 € 592,00 1 013650013

≡ 900x420x180 mm

## 1365P10

bomba hidráulica

tubo 1,5m comp, união 1/2"



1365P10 € 264,00 1 013650110

## 1366A

Tira mossas com kit de 19 pinos plásticos

Ideal para remover:

- mossas causadas por granizo
- mossas no estacionamento
- pequenas mossas em geral



1366A € 77,50 1 013660200

## 1366KF

Conjunto de 19 pinos plásticos, para artigo 1366A



1366KF € 28,50 1 013660205

## 1366/K5

tira-mossas pneumático, com percutor de 1.1 kg

O kit inclui:

- 1 ventosa Ø 75 mm
- 1 ventosa Ø 100 mm
- 1 ventosa Ø 125 mm
- 1 gancho



1366/K5 € 203,00 1 013660010

≡ 610x240x90 mm

## 1366S

aparelho de soldar por pontos com rodas

- microprocessador para gestão dos parâmetros de soldadura
- regulação da potência e tempo de soldadura
- intervalo de regulação: 400÷2200 Ah
- seletor de pontos simples, pulsados e contínuos
- tabela com parâmetros de soldadura
- indicador de proteção térmica
- pistola de aperto rápido
- voltagem: 230 V

CE



1366S € 1.415,00 1 013660000

## 1366S KIT

kit de acessórios soldadura por pontos

- 10 anilhas ranhuradas
- 10 anilhas ranhuradas 90°
- 100 pinos roscados, 5x18 mm
- 100 pinos auto-roscantes, 5x18 mm
- 100 pinos auto-roscantes, 5x25 mm
- Gancho de anilha, Ø 8x16x1.5 mm
- Eléctrodo para parafusos M5-M6
- Eléctrodo para anilhas ranhuradas



1366S KIT € 188,00 1 013660001

≡ 250x170x35

## 1366SL

alavanca tira-mossas para superfícies metálicas

Cabeça articulada com garra para utilização com arame ondulado



L mm € 164,00 1 013660002

## 1366ST

barra tira-mossas para superfícies metálicas e alumínio

Cabeça articulada com garra para utilização com arame ondulado e olhais de tração



L mm € 524,00 1 013660003

## 1366S/R1

Mandril 3 pontas



1366S/R1 € 20,20 1 013660501

### 1366S/R2

Anilhas de 3 pontas para trabalhos em chapa



1366S/R2 € 20,20 1 013660502

### 1366S/R3

electrodo para anilhas Ø 8x16x1.5 mm



1366S/R3 € 24,00 1 013660503

### 1366S/R4

Grampo, Ø 8x16x1.5 mm



1366S/R4 € 20,80 1 013660504

### 1366S/R5

Anilhas Ø 8x16x1.5mm



1366S/R5 € 11,50 1 013660505

### 1366S/R6

Electrodo para parafusos M5-M6



1366S/R6 € 24,00 1 013660506

### 1366S/R7

100 pinos auto-roscentes, 5x18 mm



1366S/R7 € 20,20 1 013660507

### 1366S/R8

100 pinos auto-roscentes, 5x25 mm



1366S/R8 € 28,00 1 013660508

### 1366S/R9

100 pinos roscados, M5 x 18 mm



1366S/R9 € 18,60 1 013660509

### 1366S/R10

10 anilhas com fenda



1366S/R10 € 12,80 1 013660510

### 1366S/R11

Electrodo para anilhas com fenda



1366S/R11 € 67,50 1 013660511

### 1366S/R12

Anilhas com fenda 10 90°



1366S/R12 € 25,50 1 013660512

### 1366S/R13

Eléctrodo de soldadura por pontos



1366S/R13 € 49,00 1 013660513

### 1366S/R14

Eléctrodo de soldadura por pontos



1366S/R14 € 23,50 1 013660514

### 1366S/R21

arame ondulado para utilização com alavanca e barra tira-mossas



1366S/R21 € 54,50 1 013660551

### 1366S/R22

suporte magnético para arame ondulado



1366S/R22 € 16,40 1 013660552

### 1366S/R24

olhal de tração M4



1366S/R24 € 64,50 1 013660554

### 1366S/R25

olhal de tração M5



1366S/R25 € 64,50 1 013660555

### 1366S/R26

olhal de tração M6



1366S/R26 € 64,50 1 013660556

## 1367/S6

Jogo de punções para instalação de sensores de estacionamento

Tamanhos:  
17 - 18 - 19 - 20 - 21 - 22 mm



1367/S6	€ 216,00	1	013670100
---------	----------	---	-----------

## 1367

punções para instalação de sensores de estacionamento



Ø mm	Ø mm	€	1	Artigo
17	13	44,00	1	013670117
18	13	44,00	1	013670118
19	13	44,00	1	013670119
20	13	44,00	1	013670120
21	13	44,00	1	013670121
22	13	44,00	1	013670122
23	13	47,00	1	013670123
24	13	47,00	1	013670124
27	13	47,00	1	013670127
28	13	47,00	1	013670128

## 1368

kit de reparação para plásticos

• Permite reparar rapidamente componentes em plástico rachados ou partidos

Potência: 220+240 V com tomada Schuko  
Extensão cabo pistola de calor: 3.5 m  
Comp. cabo eléctrico: 1.35 m  
2 regulações de potência: 35-75 W  
Pistola de aquecimento com terminais em latão, 2 ângulos de inserção do grampo: 0°-90°  
Quebra-circuitos térmico de segurança na entrada  
Fusível 10 A de segurança na saída  
Bolsa para pistola



1368	€ 370,00	1	013680001
------	----------	---	-----------

## 1368G/K400

sortido de 400 grampos para artigo 1368



1368G/K400	€ 61,50	1	013680140
------------	---------	---	-----------

## 1368G/OD

grampos roscados, a direito, para artigo 1368



1368G/OD	€ 15,30	1	013680100
----------	---------	---	-----------

## 1368G/SD

grampos em espiral, a direito, para artigo 1368



1368G/SD	€ 15,30	1	013680110
----------	---------	---	-----------

## 1368G/CV

grampos ângulo convexo para artigo 1368



1368G/CV	€ 15,30	1	013680120
----------	---------	---	-----------

## 1368G/C2U

grampos ângulo côncavo para artigo 1368



1368G/C2U	€ 15,30	1	013680130
-----------	---------	---	-----------

## 1369/C11

jogo de 11 ferramentas



1369/C11	€ 714,00	1	013690033
----------	----------	---	-----------

- 1303
- 1305
- 1306
- 1309
- 1310
- 1314
- 1327
- 1338A
- 1353
- 1357Z/40
- 1390

470x340x70 mm - 15,2 kg

## 1370

martelos para mecânico tipo alemão, cabo em madeira



UNI 7778 DIN 1041

HICKORY

g	A mm	L mm	L1 mm	€	5	Artigo
100	15	260	82	10,40	5	013700051
200	19	280	95	11,80	5	013700052
300	23	300	105	13,50	5	013700053
400	25	310	112	15,20	5	013700054
500	27	320	118	16,40	5	013700055
600	30	330	122	19,10	5	013700056
800	33	350	130	21,60	4	013700058
1000	36	360	135	25,00	4	013700060
1500	42	380	145	29,50	2	013700065
2000	47	400	155	35,00	1	013700070

## 1370/MR...

cabos de substituição para referência 1370



Artigo	€	4	Artigo
1370MR 100 1370/100	4,80	4	013700081
1370MR 200 1370/200	5,25	4	013700082
1370MR 300 1370/300	5,70	4	013700083
1370MR 400 1370/400	6,00	4	013700084
1370MR 500 1370/500	6,65	4	013700085
1370MR 600 1370/600	7,45	4	013700086
1370MR 800 1370/800	7,75	4	013700088
1370MR 1000 1370/1000	8,20	4	013700090
1370MR 1500 1370/1500	9,30	4	013700095
1370MR 2000 1370/2000	10,40	4	013700100

## 1370T

martelos para mecânico cabo em fibra



g	A mm	L mm	L1 mm	€	5	Artigo
200	19	280	95	18,00	5	013700620
300	23	300	105	19,70	5	013700630
500	27	320	118	21,30	5	013700650
800	33	350	130	22,90	4	013700680
1000	36	360	135	29,50	4	013700700
1500	42	365	145	34,50	2	013700750

## 1370F

martelos para mecânico tipo alemão, cabo em madeira



NF E 71.014

A mm	L mm	L1 mm	g	€	U	U
24	260	77	280	18,60	2	013700424
26	260	80	310	19,70	2	013700426
28	280	86	400	20,80	2	013700428
30	280	92	450	21,30	2	013700430
32	300	100	550	22,90	2	013700432
36	300	104	720	29,50	2	013700436
40	330	110	1065	33,50	2	013700440
42	330	116	1080	34,50	2	013700442
50	380	138	1760	37,00	2	013700450
60	380	160	2585	44,50	2	013700460

## 1370F/MR...

cabos de substituição para referência 1370F



Artigo	€	U	U
1370F/MR 24 1370F/24-26	4,70	2	013700474
1370F/MR 28 1370F/28-30	4,95	2	013700478
1370F/MR 32 1370F/32-36	5,80	2	013700482
1370F/MR 40 1370F/40-42	7,45	2	013700490
1370F/MR 50 1370F/50	8,30	2	013700495
1370F/MR 60 1370F/60	10,20	2	013700496

## 1370FT

martelos para mecânicos, cabos em fibra



A mm	L mm	L1 mm	g	€	U	U
28	280	86	530	31,00	1	013700528
30	280	92	625	32,00	1	013700530
32	300	100	750	34,00	1	013700532
36	300	104	930	39,50	1	013700536
40	330	110	1150	41,50	1	013700540
42	330	116	1250	43,00	1	013700542
50	380	138	2100	47,50	1	013700550
60	380	160	2750	51,00	1	013700560

## 1374F

martelo para carpinteiro tipo francês, cabo em madeira



NF E 71.012

A mm	L mm	L1 mm	g	€	U	U
16	250	80	180	14,80	2	013740416
20	270	86	250	16,40	2	013740420
22	290	92	335	16,90	2	013740422
26	290	103	425	18,60	2	013740426
28	310	108	510	19,70	2	013740428
30	310	117	580	21,30	2	013740430

## 1374F/MR...

cabos de substituição para referência 1374F



Artigo	€	U	U
1374F/MR 16 1374F/16	4,30	2	013740456
1374F/MR 20 1374F/20	4,40	2	013740460
1374F/MR 22 1374F/22-26	4,50	2	013740462
1374F/MR 28 1374F/28	5,05	2	013740468
1374F/MR 30 1374F/30	5,25	2	013740470

## 1375

martelo de orelhas, cabo em madeira

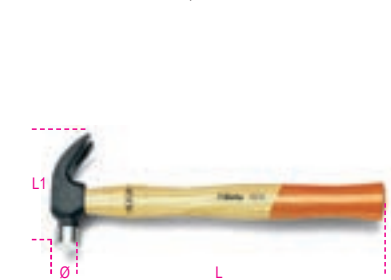

g	L1 mm	Ø mm	L mm	€	U	U
300	95	25	300	16,40	3	013750000

## 1375/MR

cabos de substituição para referência 1375



Artigo	€	U	U
1375/MR	7,45	2	013750003

## 1375A

martelo de orelhas, cabo em material plástico



oz	g	L mm	L1 mm	€	U	U
16	450	330	130	24,90	3	013750016
20	570	330	130	26,00	3	013750020

## 1375B

martelo de orelhas, cabo em aço



oz	g	L mm	L1 mm	€	U	U
16	450	330	130	22,40	3	013750026
20	570	330	130	22,90	3	013750030

## 1376X

martelo de carpinteiro com orelhas magnetizadas, cabo de madeira



g	A mm	L1 mm	L mm	€	U	U
250	20	125	450	15,90	3	013760125
300	25	130	450	16,90	3	013760130
400	27	132	450	18,00	3	013760140

## 1376X/MR

cabo de substituição para o artigo 1376X



Artigo	€	U	U
1376X/MR	9,05	2	013760161

## 1376XT

martelo de carpinteiro com orelhas magnetizadas, cabo em material plástico



g	A mm	L1 mm	L mm	€	U	U
250	20	125	500	19,70	3	013760525
300	25	130	500	20,80	3	013760530
400	27	132	500	21,80	3	013760540

## 1376XT/MR

cabo de substituição para o artigo 1376XT



Artigo	€	U	U
1376XT/MR	10,20	2	013760585

## 1377

martelos com batente redondo e pena esférica, cabo em madeira



g	L mm	L1 mm	€	U	U
340	330	95	24,60	2	013770134
450	350	102	25,50	2	013770145
570	350	110	29,50	2	013770157
680	360	116	30,00	2	013770168
900	380	120	33,00	2	013770190

## 1377/MR...

cabos de substituição  
para referência 1377



	€		
1377MR 340 1377/340	5,25	2	013770234
1377MR 450 1377/450	6,15	2	013770245
1377MR 570 1377/570	6,80	2	013770257
1377MR 680 1377/680	6,90	2	013770268
1377MR 900 1377/900	8,55	2	013770290

## 1377T

Martelo batente redondo e pena simétrica,  
cabo redondo em fibra, para trabalhos em  
latão ou estanho



g	L mm	L1 mm	€		
340	330	95	22,40	2	013770534
450	350	102	27,00	2	013770545
570	350	110	30,00	2	013770557
680	360	116	32,50	2	013770568
900	380	120	37,00	2	013770590

## 1378

martelos com batente redondo  
e pena simétrica, cabo em madeira



g	L mm	L1 mm	Ø mm	€		
340	330	100	27	22,40	2	013780134
570	350	115	32	29,50	2	013780157

## 1378/MR...

cabos de substituição  
para referência 1378



	€		
1378MR 340 1378/340	5,05	2	013780234
1378MR 570 1378/570	7,00	2	013780257

## 1379F

martelo tipo francês para electricista,  
cabo em madeira



NF E 71.011

A mm	L mm	L1 mm	€		
16	250	126	14,80	2	013790416
18	250	135	15,90	2	013790418
20	260	142	16,90	2	013790420

## 1379F/MR...

cabos de substituição  
para referência 1379F



	€		
1379F/MR 16 1379F/16-18 1379F/MR 20 1379F/20	4,60	2	013790426
	5,05	2	013790430

## 1380

marretas cabo em madeira



UNI 7777 DIN 6475

g	A mm	L mm	L1 mm	€		
800	38	260	90	18,60	2	013800208
1000	40	260	95	20,20	2	013800210
1250	43	260	100	21,30	2	013800212
1500	45	280	110	24,00	2	013800215
2000	50	300	120	32,00	2	013800220

## 1380/MR...

cabos de substituição para referência 1380



	€		
1380MR 800 1380/800-1000-1250	5,90	2	013800238
1380MR 1500 1380/1500	6,35	2	013800245
1380MR 2000 1380/2000	7,10	2	013800250

## 1380S

marretas com colar salva mãos  
cabo em madeira



g	A mm	L mm	L1 mm	€		
800	36	260	90	20,20	2	013800400
1000	39	260	95	22,40	2	013800405
1250	43	260	100	24,00	2	013800410
1500	45	260	110	27,00	2	013800415

## 1380S/MR...

cabos de substituição  
para referência 1380S



	€		
1380S/MR 800 1380S/800-1000-1250	6,25	2	013800417
1380S/MR 1500 1380S/1500	6,80	2	013800419

## 1380T

Marreta,  
cabo em fibra



g	A mm	L mm	L1 mm	€		
800	35	260	85	28,50	2	013800308
1000	40	260	100	29,00	2	013800310
1250	42	260	110	31,50	2	013800312
1500	45	260	120	34,00	2	013800315

## 1381

marretas serviço pesado  
cabo em madeira de castanheiro americano



g	A mm	L mm	L1 mm	€		
3000	55	800	142	75,50	1	013810030
4000	60	900	152	84,00	1	013810040
5000	70	900	162	95,50	1	013810050
8000*	80	900	185	164,00	1	013810080

\* = cabo em madeira freixo

## 1381/MR...

cabos de substituição  
para referência 1381

	€		
1381MR 3-4 1381/3000-4000	38,50	2	013810730
1381MR 5 1381/5000	40,00	2	013810750
1381MR 8 1381/8000	40,50	2	013810780

## 1381T

marreta com cabo em fibra



g	A mm	L mm	L1 mm	€		
3000	55	900	142	83,00	1	013810330
4000	60	900	152	91,50	1	013810340
5000	70	900	162	103,50	1	013810350

## 1385

marretas com cabeça em cobre  
cabo em madeira



g	A mm	L mm	L1 mm	€		
400	26	260	75	28,50	2	013850404
600	32	270	80	41,00	2	013850406
800	34	280	90	53,50	2	013850408
1000	37	280	100	66,50	2	013850410
1500	43	280	110	98,50	2	013850415
2000	48	300	120	132,00	1	013850420

## 1385/MR

cabo de substituição para o artigo 1385

	€		
1385MR 400 1385 400	8,40	2	013850464
1385MR 600 1385 600	8,65	2	013850466
1385MR 800 1385 800	8,95	2	013850468
1385MR 1000 1385 1000	9,50	2	013850470
1385MR 1500 1385 1500	10,40	1	013850475
1385MR 2000 1385 2000	10,90	1	013850480

## 1390

martelos com batentes plásticos  
intermutáveis, cabo em madeira



UNI 7784

Ø mm	L mm	L1 mm	€		
22	260	70	16,40	5	013900022
28	280	85	20,20	5	013900028
35	310	95	27,50	5	013900035
45	320	107	44,00	4	013900045
60	380	128	75,00	2	013900060

## 1390/MR...

cabos de substituição  
para referência 1390

	€		
1390MR 22 1390/22	4,05	2	013900222
1390MR 28 1390/28	4,60	2	013900228
1390MR 35 1390/35	5,45	2	013900235
1390MR 45 1390/45	6,65	2	013900245
1390MR 60 1390/60	8,30	2	013900260

## 1390R

batente de substituição para refª. 1390



Ø mm	€		
22	2,55	4	013900122
28	3,95	4	013900128
35	5,30	4	013900135
45	9,05	4	013900145
60	15,70	4	013900160

## 1390N

Martelo com batentes em plástico, cabo em madeira

Batentes dureza média: 75 Shore  
Resistente a óleo e ao desgaste  
Particularmente adequado para trabalhar metal



Ø mm	L mm	L1 mm	€		
22	260	70	16,40	3	013900522
28	280	85	20,20	3	013900528
35	310	95	27,50	3	013900535
45	320	107	44,00	2	013900545
60	380	128	75,00	2	013900560

## 1390NR

batentes em nylon de substituição para ref.  
1390N



Ø mm	€		
22	2,55	4	013900622
28	3,95	4	013900628
35	5,30	4	013900635
45	9,05	4	013900645
60	15,70	4	013900660

## 1391

martelos anti-recuo totalmente  
revestidos a borracha



Ø mm	L mm	L1 mm	€		
35	280	90	25,00	2	013910135
50	320	105	33,50	2	013910150
55	355	110	39,50	2	013910155
65	380	130	53,50	2	013910165

## 1391A

maceta para assentar tijoleira  
totalmente revestida a borracha branca



g	Ø mm	L mm	L1 mm	€		
500	45	290	100	24,00	2	013910205
1000	60	300	120	32,00	2	013910210

## 1392

martelos anti-recuo com batentes  
intermutáveis, cabo em aço



Ø mm	L mm	L1 mm	€		
30	300	105	43,00	2	013920030
35	305	115	46,00	2	013920035
40	310	125	52,00	2	013920040
50	325	135	62,50	2	013920050
60	385	155	95,00	2	013920060



## 1392R

batente de substituição para ref<sup>a</sup>. 1392



Ø mm	€		
30	5,70	4	013920230
35	8,40	4	013920235
40	12,70	4	013920240
50	16,90	4	013920250
60	25,50	4	013920260

## 1393

martelo com batente em borracha dura



Ø mm	L mm	L1 mm	€		
50	315	90	11,30	3	013930050
60	340	110	12,80	3	013930060
70	370	130	15,10	2	013930070

## 1410/M

chave de gancho para molas



Ø mm	€		
3,5	15,90	2	014100051

## 1428

extractor de porcas com quadra macho



mm	□	L mm	Ø mm	€		
8	3/8	36	17	15,90	2	014280008
10	3/8	36	17	15,90	2	014280010
11	3/8	36	17	15,90	2	014280011
12	3/8	36	19	15,90	2	014280012
13	3/8	36	19	15,90	2	014280013
14	3/8	36	19	15,90	2	014280014
15	1/2	38	21	16,90	2	014280015
16	1/2	38	21	16,90	2	014280016
17	1/2	38	21	16,90	2	014280017
18	1/2	38	26	16,90	2	014280018
19	1/2	38	26	16,90	2	014280019
20	1/2	38	26	18,60	2	014280020
21	1/2	38	26	18,60	2	014280021
22	1/2	38	26	20,20	2	014280022
24	1/2	38	26	20,20	2	014280024
27	1/2	38	26	21,30	2	014280027

## 1428L

extractores, série longa, para porcas de aperto direito danificadas, com quadra



mm	€		
17	41,00	1	014280217
19	42,00	1	014280219
21	45,50	1	014280221

12"



1428L/B3	€		
17-19-21 mm	129,00	1	014280303

3/8"

12"



1428/SB11	€		
8-10-11-12-13-14 15-16-17-18-19 mm	193,00	1	014280111
1428/SB5	€		
20-21-22-24-27 mm	106,00	1	014280115

## 1429

extractor de porcas e parafusos com quadra macho



mm	□	L mm	€		
2	3/8	60	10,60	3	014290002
3	3/8	60	10,60	3	014290003
4	3/8	60	10,60	3	014290004
5	3/8	60	11,30	2	014290005
6	3/8	60	11,30	2	014290006
8	1/2	70	12,00	2	014290008
10	1/2	70	12,30	2	014290010

3/8"

12"



1429/SB7	€		
2-3-4-5-6-8-10 mm	87,50	1	014290107

## 1430/...

extractores cónicos de parafusos em aço ligado

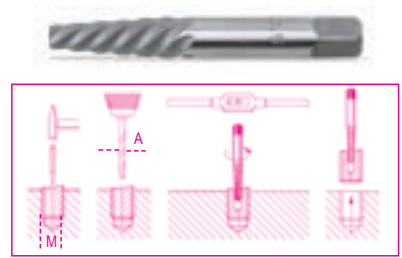

	M	A mm	€		
1430/1	3+6	2,5	3,00	10	014300006
1430/2	6+8	3,0	3,30	10	014300008
1430/3	8+11	4,5	3,95	10	014300011
1430/4	11+14	6,0	5,20	10	014300014
1430/5	14+18	8,0	5,90	10	014300018
1430/6	18+24	11,0	11,50	5	014300024
1430/7	24+33	14,0	17,40	5	014300033
1430/8	33+50	21,0	22,20	5	014300050



1430/S5	€		
1430/1-1430/2-1430/3 1430/4-1430/5	22,40	1	014300105
1430/S6	€		
1430/1-1430/2-1430/3 1430/4-1430/5-1430/6	33,00	1	014300106
1430/S8	€		
1430/1-1430/2-1430/3 1430/4-1430/5-1430/6 1430/7-1430/8	72,00	1	014300108

## 1433

Saca pernos

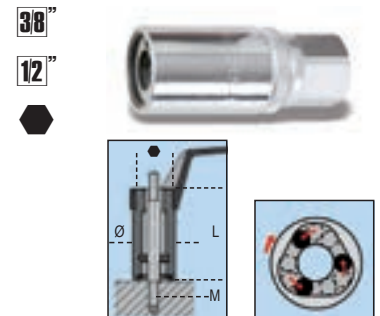

M mm	Ø mm	L mm	● mm	□	€		
5	21	60	19	3/8	11,80	2	014330005
6	24	60	21	1/2	11,80	2	014330006
7	24	60	21	1/2	11,80	2	014330007
8	24	60	21	1/2	11,80	2	014330008
9	28	70	21	1/2	13,90	2	014330009
10	28	70	21	1/2	13,90	2	014330010
10,5	28	70	21	1/2	13,90	2	014330021
11	28	70	21	1/2	13,90	2	014330011
12	28	70	21	1/2	13,90	2	014330012
14	36	72	24	-	21,80	2	014330014
16	36	72	24	-	21,80	2	014330016

### 1433/C11

saca pernos com roletes com encadouro quadrado fêmea 1/2"



1433/C11 228,00 € 1 014330311  
M5 - M6 - M7 - M8 - M9 - M10 - M10,5  
M11 - M12 - M14 - M16

340x135x56 mm - 3,0 kg

### 1435

extractor excêntrico de pernos



Ø mm 4÷20 87,50 € 1 014350001

### 1435R

patela excêntrica de substituição para a refª. 1435



1435R 26,00 € 1 014350010

### 1435/1

extractor excêntrico de pernos



Ø mm 19÷26 109,00 € 1 014350002

### 1435/1R

patela excêntrica de substituição para a refª. 1435/1



1435/1R 27,50 € 1 014350011

### 1437/C12

Jogo de 12 ferramentas para remoção de air bags



1437/C12 86,50 € 1 014370001  
260x160x55 mm - 1,0 kg

### 1438

aparelho para centrar embraiagens com 3 cones expansivos



1438 46,50 € 1 014380001

### 1438R

cones expansivos de substituição para a refª. 1438



Ø mm 14÷18 3,20 € 5 014380101  
18÷21 3,20 € 5 014380102  
22÷25 3,20 € 5 014380103

### 1438K/DSG

jogo de 13 ferramentas para remoção, instalação e regulação de embraiagens dSg VW 6 e 7 velocidades

Permite trabalhar em transmissões automáticas e eletrônicas de caixas de velocidades duplas. Inclui alicate para remoção/ instalação de anéis de retenção do eixo principal e manômetro de regulação do sistema de embraiagem



1438K/DSG 803,00 € 1 014380250

### 1438DSG

Alavanca para bloquear/desbloquear caixas de velocidades DSG de dupla embraiagem do grupo VAG



1438DSG 27,50 € 1 014380200

### 1438SAC

aparelho para centrar embraiagens SAC (Bimassa)

Inclui kit para aplicações sem necessidade de guia de rolamentos  
Fornecido com acessório 3 e 4 braços



1438 SAC 1.036,00 € 1 014380050

### 1439/K7

porta-pontas angular (90°), série longa, com pontas, em caixa

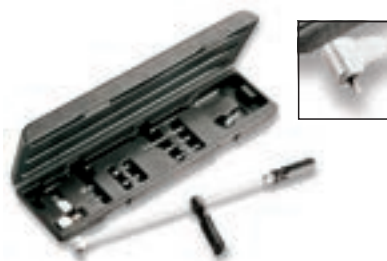

Conteúdo da caixa:  
- Porta-pontas angular  
- 1 cabeça para parafusos de perfil de fenda  
- 1 cabeça 1/4" para pontas  
- 1 cabeça especial para pontas  
- 7 pontas especiais

1439K7 175,00 € 1 014390101

500x120x60 mm 825 g

# Beta

## 1440/...

cintas para segmentos



	Ø mm	L mm	€		
1440/0	40÷75	50	25,00	1	014400000
1440/1	57÷125	80	34,00	1	014400010
1440/1A	57÷125	100	38,50	1	014400011
1440/2	90÷175	80	41,00	1	014400020
1440/2A	90÷175	100	43,00	1	014400021
1440/3	90÷175	165	63,50	1	014400030

## 1445/1 - 1445/2

grampo para segmentos



	Ø mm	€		
1445/1	50÷100	35,00	1	014450001
1445/2	90÷150	45,50	1	014450002

## 1450GC

grampo para válvulas com bicos direitos e curvos



	€		
1450GC	102,50	1	014500005

## 1452K

compressor de molas de válvulas, com três matrizes

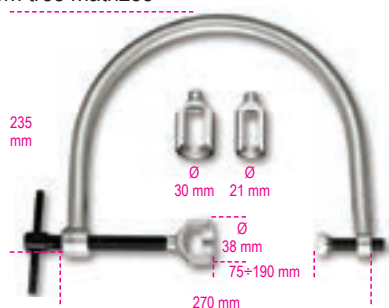

	€		
1452K	133,00	1	014520100

## 1452PN/K

compressor pneumático para molas de válvulas

Pressão de impulso: 1400 N



Ø mm	L mm	L1 mm	€		
16-19-23	230	185	287,00	1	014520110
25-30-42					

## 1455SVP

rectificador de válvulas pneumático

• Pressão de alimentação: 6 bar



	€		
1455SVP	325,00	1	014550001

## 1455SVP/R...

ventosas em borracha de substituição para a refª. 1455SVP



	€		
1455SVP/R1	5,45	5	014550501
1455SVP/R2	5,45	5	014550502
1455SVP/R3	5,45	5	014550503

## 1457/B4

jogo de ferramentas para remover uniões de tubos Rilsan

Tamanhos incluídos:

- 6x8
- 10x12
- 15x16
- 18x12



	€		
1457/B4	41,50	1	014570024

## 1458

alicate para anéis de segurança



Ø mm	€		
30÷100	65,00	2	014580001

## 1460F

alicate para as juntas de afinação das válvulas



	€		
1460F	54,50	1	014600010

## 1461/C3B

dispositivo de afinação para motores a gasolina

Fiat/Alfa/Lancia

Motores: 1.2-1.4 16V



	€		
1461/C3B	295,00	1	014610032

280x245x75 mm 1,5 kg

## 1461/C5G

dispositivo de afinação para motores a diesel

Fiat/Alfa/Lancia/Opel/Suzuki/Ford

Motores: 1.3 Multijet



	€		
1461/C5G	257,00	1	014610053

280x245x75 mm 2,6 kg

### 1461/C6B

dispositivo de afinação para motores a gasolina

Peugeot/Citroën

Motores: 1.0-1.1-1.4-1.6-1.6 16v-1.6Gti-1.6 18V-1.8-1.8 16v-1.9-2.0-2.0 16v-2.0T-2.0 Hpi-2.2 16v



1461/C6B € 404,00 1 014610063  
310x290x120 mm 3,5 kg

### 1461/C6G

dispositivo de afinação para motores a diesel Peugeot/Citroën

Motores: 1.4-1.6-2.0D,1.4-1.6TDCi, 1.4-1.6-2.0-2.2Hdi, 1.5-1.9-2.5D



1461/C6G € 524,00 1 014610064  
385x290x100 mm 3,8 kg

### 1461/C7B

dispositivo de afinação para motores a gasolina Renault/Nissan

Motores: 1.4-1.6-1.8-2.0 16V



1461/C7B € 306,00 1 014610072  
280x245x75 mm 3,2 kg

### 1461/C8B

dispositivo de afinação para motores a gasolina

Ford

Motores: 1.25-1.4-1.6-1.6 SCTi-1.6 Ti-VCT-1.6 16V



1461/C8B € 208,00 1 014610083  
240x210x50 mm 1,8 kg

### 1461/C8G

dispositivo de afinação para motores a diesel Ford/Mazda

Motores: 1.4-1.6-1.8-2.0-2.2 TDCi, 1.6D 8/16V, 1.8D, 1.8D Turbo, 1.8 TCi, 1.8 TDDi, 2.5D, 2.5D Turbo



1461/C8G € 360,00 1 014610084  
280x245x75 mm 2,2 kg

### 1461/C9B

dispositivo de afinação para motores a gasolina Opel

Motores: 1.0 12V, 1.0-1.2-1.4 16V



1461/C9B € 169,00 1 014610092  
335x145x60 mm 2 kg

### 1461/C10A

dispositivo de afinação para motores Audi, Seat, Skoda e Volkswagen

Motores: 1.9 - 2.0 TDI



1461/C10A € 152,00 1 014610101  
270x120x45 mm - 1,1 kg

### 1461/C10G

Temporizadores para motores Volkswagen/Audi/Seat e Skoda

Motores: 1.2-1.6-2.0 TDI CR (common rail)



1461/C10G € 507,00 1 014610103  
310x290x120 mm 2,8 kg

### 1461/C11A

dispositivo de afinação para motores Renault

Motores: 2.0 dCi



1461/C11A € 174,00 1 014610111  
420x280x60 mm - 1,2 kg



## 1461/C11G

dispositivo de afinação para motores Renault

Motores: 1.5-1.9-2.2-2.5 DCI



1461/C11G € 415,00 1 014610113  
310x290x120 mm 3,8 kg

## 1461/C12A

dispositivo de afinação para motores Fiat

Motores: 1.9-2.2 JTS e 1.9 JTD Euro 4



1461/C12A € 306,00 1 014610123  
280x245x75 mm - 1,8 kg

## 1461/C12G

Temporizadores para motores Fiat/Alfa/Lancia diesel

Motores: 1.9 JTD, 1.6-1.9-2.0 Multijet



1461/C12G € 273,00 1 014610124  
280x245x75 mm 2 kg

# Beta

## 1461/C13A

Temporizadores para motores turbo Fiat 0.9 Twinair



1461/C13A € 144,00 1 014610133  
240x210x50 mm 1,7 kg

## 1461/C13B

Temporizadores para motores Fiat 1.4 Multiair



1461/C13B € 221,00 1 014610134  
240x210x50 mm 2,8 kg

## 1461/C17B

dispositivo de afinação para motores a gasolina Volkswagen/Audi/Seat e Skoda

Motores: 1.2 TSI



1461/C17B € 123,00 1 014610171

## 1461/C18B

dispositivo de afinação para motores a gasolina Volkswagen/Audi/Seat e Skoda

Motores: 1.6-1.8-1.8T, 1.4-1.6-1.8-2.0 16V, 1.4-1.6-2.0 FSI



1461/C18B € 398,00 1 014610182  
310x290x120 mm 2,5 kg

## 1461/C20G

dispositivo de afinação para motores a diesel Fiat Iveco/Peugeot/Citroën/Ford

Motores: 2.2-2.3-3.0 Multijet



1461/C20G € 693,00 1 014610221  
385x290x100 mm 5,5 kg

## 1461/C21G

dispositivo de afinação para motores a diesel Renault Motores: 1.6 dCi



1461/C21G € 409,00 1 014610222  
310x290x120 mm 3 kg

# Beta

# Beta

### 1461/C22B

dispositivo de afinação para motores a gasolina Peugeot/Citroën

Motores: 1.0-1.2 VTi



1461/C22B € 377,00 1 014610223

280x245x75 mm 2 kg

### 1461/C23B

dispositivo de afinação para motores a gasolina Opel

Motores: 1.0 - 1.2 - 1.4 ecoflex



1461/C23B € 491,00 1 014610224

280x245x75 mm 2,5 kg

### 1461/C24B

dispositivo de afinação para motores a gasolina Mini-Peugeot/Citroën

Motores: 1.4 - 1.6 (N12-N14)



1461/C24B € 611,00 1 014610225

280x245x75 mm 2,8 kg

### 1461/C25G

dispositivo de afinação para motores a diesel Mini

Motores: 1.6 diesel (W16D)



1461/C25G € 137,00 1 014610226

270x120x45 mm 1 kg

### 1461/C26B

dispositivo de afinação para motores a gasolina Fiat/Alfa Romeo/Lancia

Motores: 1.2-1.4 8v



1461/C26B € 338,00 1 014610227

280x245x75 mm 1,7 kg

### 1461/C27G

dispositivo de afinação para motores a diesel Bmw

Motores: 1.6-2.0D (N47-N47S)



1461/C27G € 246,00 1 014610228

280x245x75 mm 2 kg

### 1461/C28B

temporizadores para motores a gasolina Volkswagen, Seat e Skoda

motores 1.0 - 1.0 Bluemotion Tech  
1.0 Ecofuel/Ecomotive - 1.0 Green Tech



1461/C28B € 436,00 1 014610229

280x245x75 mm - 1,7 kg

### 1461/C29B

temporizadores para motores a gasolina Ford

motores 1.0 EcoBoost



1461/C29B € 627,00 1 014610209

280x245x75 mm - 2,6 kg

### 1461/C30G

temporizadores para motores a diesel Volkswagen/Audi/Seat e Skoda

motores 1.6-2.0 CR TDI  
para motores fabricados a partir de 2012



1461/C30G € 545,00 1 014610231

280x245x75 mm - 2 kg

## 1462CF/C6

Jogo de 6 chaves de caixa bi-sextavadas para injectores

Tamanhos:  
12-14-16-17-18-19 mm



1462CF/C6 € 84,00 1 014620006

260x145x60 mm - 1,2 kg

## 1462CF

Jogo de chaves de caixa bi-sextavadas para injectores



mm	€		
12	13,50	1	014620012
14	13,50	1	014620014
16	14,00	1	014620016
17	14,00	1	014620017
19	14,50	1	014620019
18	14,50	1	014620018

## 1462/KD

jogo ferramentas para remoção de injectores Denso, completo com martelo



1462/KD € 750,00 1 014620060

335x210x80 mm - 4,8 kg

## 1462/KI

Jogo de extractores de injectores common rail diesel

Permite a remoção de injectores DELPHI-BOSCH-SIEMENS-DENSO



1462/KI € 2.225,00 1 014620235

530x470x140 mm - 20 kg

## 1462/KMRC

jogo de ferramentas para remoção de injectores de motores Mercedes 2.1L, 2.2L, 3.0 V6 e Chrysler

Para injectores Bosch (2.1 e 2.2L) e Delphi (3.0)  
Permite a remoção de injectores sem extrair o motor.

Particularmente adequado para os seguintes modelos:  
Mercedes Vito, Vario, CLK, Sprinter, Viano, Classes M, GL, C, GLK, E, CLS, S, R, G  
Chrysler 300 C



1462/KMRC € 628,00 1 014620070

310x300x118 mm - 3,5 kg

## 1462/KU

jogo universal para remoção de injectores diesel common rail

Completo com alicate e martelo



1462/KU € 660,00 1 014620100

390x290x100 mm - 4,5 kg

## 1462AD/BSC

adaptador para remoção de injectores Bosch common rail

Para utilização com os artigos Beta 960KI e Beta 1462/KU



1462AD/BSC € 191,00 1 014620435

## 1462AD/SMN

jogo de adaptadores para remoção de injectores Siemens e Denso

Para utilização com o item Beta 960KI/1462KI



1462AD/SMN € 287,00 1 014620436

## 1462PIM

Placas para manutenção de injectores, par

As placas devem ser presas no torno secções:  
Ø 11-12-13-14-16-19-20 mm



1462PIM € 93,00 1 014620502

## 1463/KIT

kit de fixação da polia da árvore de cames



1463/KIT € 349,00 1 014630001

280x140x75 mm - 1,2 kg

## 1464T

Compressómetro digital

### ESPECIFICAÇÕES

- Ecrã touch 5"
- Bateria de lítio recarregável com sensor 80 bar (para baixa pressão) e cabo USB



1464T € 774,00 1 014640050

## 960AD/TP2

jogo de adaptadores para artigo 960TP em caixa plástica



960AD/TP2 € 459,00 1 009600510

≡ 430x310x50 mm - 3,2 kg

## 1464AP

Kit para teste do sistema de alta pressão em motores common rail diesel, com artigo 1464T

### Equipado com:

- jogo mangueiras de alta pressão
- uniões
- sensor 2,000 bar



1464AP € 697,00 1 014640450

≡ 430x310x50 mm - 1,8 kg

## 1464APB

Kit para teste do sistema de alta pressão em motores diesel FSI petrol, com artigo 1464T

Equipado com sensor 200 bar e conectores



1464APB € 344,00 1 014640500

≡ 240x210x50 mm - 0,5

## 1464FG

jogo de reguladores falsos para inspeção de sistema common rail diesel (utilização com item Beta 1464T-1464AP)

Utilizado com os adaptadores e dispositivo de teste adequados, possibilita determinar se o problema se encontra na bomba de alta pressão ou no regulador quando não existe pressão no circuito em motores common rail. Recomendado para reguladores de pressão Bosch, Delphi, Denso e Siemens.



1464FG € 269,00 1 014640470

≡ 350x250x80 mm - 1,8

## 1464IC

Jogo de adaptadores para artigo 1464T

Permite a ligação ao motor para verificar a compressão em motores diesel com o aparelho de teste digital 1464T.



### Conteúdo:

- 22 velas de incandescência falsas
- 5 injectores falsos
- 1 injector falso universal para pesados, motores de embarcações e máquinas agrícolas

1464IC € 513,00 1 014640350

≡ 559x312x50 mm - 4,5 kg

## 1464PB

jogo de 9 conectores para teste de baixa pressão de combustível (utilização com item 1464T)

Conectores rápidos para dispositivo de teste 1464T para rápida verificação da baixa pressão do combustível em motores a gasolina e a diesel.



1464PB € 471,00 1 014640700

≡ 530x440x120 mm - 3,8 kg

## 1464PF

Kit para testar pressão da bomba de travões, com artigo 1464T

Equipado com adaptadores e conectores



1464PF € 620,00 1 014640650

≡ 400x280x60 mm - 3 kg





## 1464PT

Kit para teste da pressão do turbo, com artigo 1464T

Equipado com sensor e cabo de ligação



1464PT € 150,00 1 014640550

240x210x50 mm - 380 g

## 1464TDI

Kit para teste da bomba de pressão em motores TDI, com artigo 1464T

Equipado com conector



1464TDI € 106,50 1 014640600

240x210x50 mm - 400 g

## 1466/C5

Kit de 5 chaves para extração de líquido de travões

Contém:

- 5 chaves tamanhos 7-8-9-10-11 mm
- 1 tubo de drenagem com válvula de retenção



1466/C5 € 112,00 1 014660100

260x170x50 mm - 600 g

# Beta

## 1467

extractor de líquido de travões



Pressão: min 5 bar, max 11.5 bar

1467 1,5 € 300,00 1 014670001

## 1467/RK1

kit de substituição de tubo para artigo 1467



1467/RK1 € 22,40 1 014670501

## 1467/RK2

filtro de substituição para artigo 1467



1467/RK2 € 86,50 1 014670502

## 1467LF

aparelho electrónico para substituição do líquido dos travões

Com "efeito pulsante"



"efeito pulsante"

- Para automaticamente quando o depósito está vazio, evitando a entrada de ar
  - Volume máximo do depósito: 20 l
  - Pressão de trabalho: 0.4+3.5 bar
  - Alimentação: 230V
- Fornecido com:
- Depósito de recolha do líquido de travões
  - 1 adaptador universal + 1 adaptador standard E20

1467LF € 1.790,00 1 014670100

## 1467LF/RC

recipiente com tubo de recuperação de líquido de travões para artigo 1467LF



1467LF RC € 87,50 1 014670125

## 1468N

depressores de válvulas para a remoção do disco

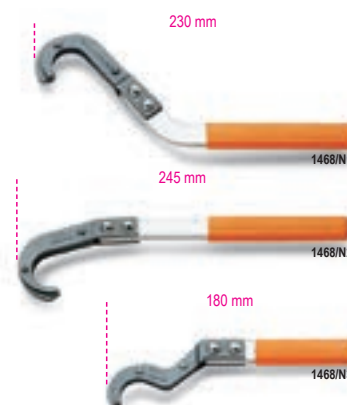

1468N/1	€ 21,30	1	014680011
1468N/2	€ 21,80	1	014680012
1468N/3	€ 22,40	1	014680013

## 1470

alicate para as molas dos travões de tambor



L mm	€		
210	35,00	1	014700001
330	46,00	1	014700002
540	138,00	1	014700010

# Beta

## 1470FT

Alicate para as molas dos travões de tambor

Pontas em ângulo de 40°  
Acesso fácil a espaços exíguos

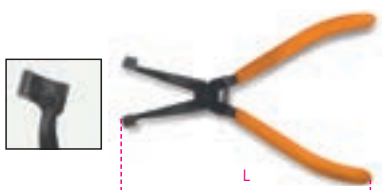

L mm	€		
184	37,50	1	014700000

## 1471

alicate para as molas dos travões de tambor



L mm	€		
330	69,00	1	014710001

## 1471A

alicate para cabos de travões de mão



A max mm	B mm	€		
45	5	84,00	2	014710010

## 1471M/C22

ferramenta pneumática para rodar e recuar os êmbolos de travões direitos e esquerdos, com acessórios



1471M/C22	€		
	270,00	1	014710101

350x310x85 mm - 3,5 kg

## 1471M/50

ferramenta pneumática para rodar e recuar os êmbolos de travões direitos e esquerdos, com acessórios



∅ mm	Kg	Bar	€		
50	150	5÷8	151,00	1	014710069

## 1471M/P

Adaptador de calços e pinças de travão TRW-Mégane



1471M/P	€		
	22,90	1	014710080

## 1471M/W50

adaptador de travão de mão VW Passat (posterior a 2005)

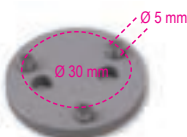

1471M/W50	€		
	8,10	1	014710079

## 1471PN/B1

adaptador de travão de mão Ford

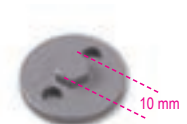

1471PN/B1	€		
	8,00	1	014710081

## 1471PN/B2

adaptador de travão Daily



1471PN/B2	€		
	11,20	1	014710082

## 1471PN/B3

adaptador de travão de mão BMW

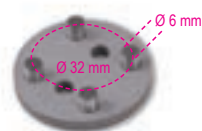

1471PN/B3	€		
	8,00	1	014710083

## 1471PN/B4

adaptador de travão de mão BMW

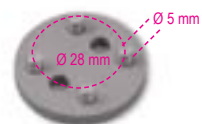

1471PN/B4	€		
	8,00	1	014710084

## 1471PN/B5

adaptador de travão de mão BMW/Mini



1471PN/B5	€		
	6,90	1	014710085

## 1471CF

chave de caixa pentagonal para aperto de porcas de pinças de travões



mm	€		
14	15,30	1	014710314
19	15,30	1	014710319

## 1471CM

chave de caixa pentagonal para aperto de parafusos de pinças de travões



mm	€		
10	15,30	1	014710360

## 1471CM/E11

Chave de caixa sextavada, 11 mm, para parafusos das pinças de travão Mercedes ML (série 166)



mm	Ø mm	L mm	L1 mm	€	1	014710361
11	24	75	15,5	16,40		

## 1471D2

ferramenta para recuar êmbolos dos discos de travões, com pinças fechadas  
Dois pares de placas para trabalhar com 2 e 4 pinças



mm	€	1	014710301
10	69,50		

250x170x60 mm 1,5 kg

## 1472

alicate para abraçadeiras



1472	€	1	014720001
	40,00		

## 1472AU

alicate para abraçadeiras



Ø mm	€	1	014720100
18+53	117,00		

## 1472R/AU

pontas de substituição para alicate 1472AU



1472AU/R	€	1	014720101
	44,50		

## 1472AU/P

alicate com extensão para abraçadeiras de fecho automático



Ø mm	L mm	€	1	014720105
18+54	630	101,50		

## 1472AU/RP

cabo de substituição para alicate 1472AU/P



1472AUP/R	€	1	014720106
	24,60		

## 1472FC

alicate para abraçadeiras Clic(R) com cabeça rotativa



1472FC	€	1	014720090
	36,00		

## 1472FC/GE

alicate para abraçadeiras clic®

Particularmente adequado para abraçadeiras grandes dimensões



L mm	€	1	014720093
230	63,50		

## 1472FC/L

alicate para abraçadeiras Clic® com extensão flexível



L mm	€	1	014720095
630 mm	98,50		

## 1472FCL/RP

cabo de substituição para alicate 1472FC/L



1472FCL/RP	€	1	014720096
	43,50		

## 1472FCA

Alicate para abraçadeiras tipo Visa®



1472FCA	€	1	014720041
	55,50		

## 1472H

ferramenta para remover abraçadeiras Henn



1472H	L mm	€	1	014720000
	100	21,30		

## 1472TM

alicate para abraçadeiras de filtros multijet



1472TM	€	1	014720200
	25,00		