

A HISTÓRIA DAS FERRAMENTAS ITALIANAS

1923 - Alessandro Ciceri fundou a “Alessandro Ciceri & Figli”, dedicada à produção de moldes em ferro e aço.

1939 - Foi registada a marca Beta, focalizada sobretudo na produção de ferramentas para profissionais.

1960 - A Beta Utensili contava com 200 colaboradores, dava início à exportação dos seus produtos e destacava-se como fabricante em ascensão de ferramentas para profissionais.

1969 - Foi desenvolvido o revolucionário trolley “Tank” em chapa metálica cor de laranja; a partir desse momento a cor laranja tornou-se a imagem de marca da Beta.

1971 - A Beta Utensili entra no mundo do desporto automóvel, com o objectivo de testar e desenvolver os seus produtos.

1975 - A Empresa consegue a sua primeira vitória na Formula 1 com o March laranja da Beta Utensili pilotado por Vittorio Brambilla, que ganhou o Grande Prémio da Áustria em Zeltweg, sob chuva intensa.

1980 - A Beta Utensili intensificou a sua presença nos principais mercados europeus, criando progressivamente filiais em França, Inglaterra, Holanda, Espanha, Polónia e Hungria.

1995 - Em apenas 8 meses a Empresa conseguiu obter a certificação do seu Sistema de Qualidade conforme os padrões na norma ISO 9001.

2000 - O lançamento do novo catálogo Beta Utensili confirmou o crescimento em curso. A gama de artigos disponíveis duplicou, e as mais de 10,000 referências foram divididas em 20 famílias de produtos.

2002 - A gama Beta Utensili foi ampliada e complementada com calçado de segurança e vestuário de trabalho e lazer, a gama “Beta Work”.

2009 - A Beta continuou a expandir os seus mercados e inaugura a Beta China.

2012 - Foi fundada a Beta Brasil.

2016 - A Beta apresenta a nova oficina modular.

2018 - **BM** Em 2018 a BM S.p.A - líder na produção e venda de terminais de cravar e sistemas elétricos - integrou o Grupo Beta.

2019 - O contínuo crescimento da marca traduz-se na actual gama de produtos – distribuída por todo o mundo – que ultrapassa as 12,000 referências, concebidas para satisfazer as necessidades dos profissionais mais exigentes.



1939 Departamento de forja



1950 Departamento de galvanização



1955 Departamento de cisalhamento



1960 Armazém



1969 Trolley “Tank”

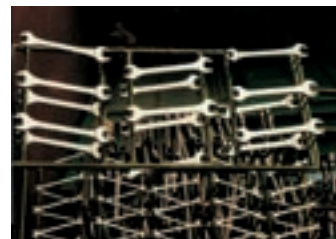

1975 Acabamento cromado



1974 Vittorio Brambilla

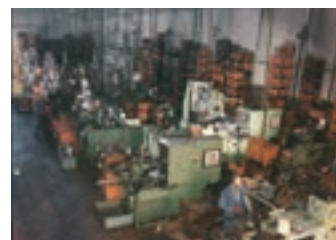

1980 Departamento de engenharia



1981 Novos jogos de ferramentas



2002 “BetaWork”



2016 Mobiliário para Oficina RSC55



2018 Fabio Quartararo

BETA UTENSILI S.p.A. - 20845 Sovico (MB)
Via A.Volta, 18 - Tel. 039.2077.1 - Telefax 039.2010742
www.beta-tools.com

Robur Wire acessórios para cabos: 67039 Sulmona (AQ)
Zona industriale - C.da S. Nicola - Tel. 0864.2504.1 - Telefax 0864.253132
www.roburitaly.com - info@roburitaly.com

1939



1950



1960



1970



1980





Sovico (Monza Brianza)

3 UNIDADES DE PRODUÇÃO

- **Mais de 500** colaboradores

- **100,000** metros quadrados, dos quais **32,000 m²** área coberta

- **Mais de 10 milhões** unidades/ano



Castiglione d'Adda (Lodi)



Sulmona (L'Aquila)



PESQUISA E DESENVOLVIMENTO

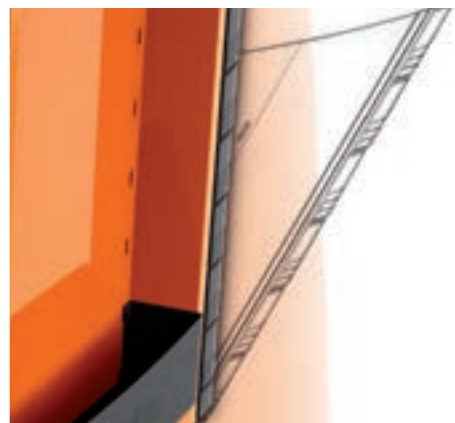

Ergonomia, acabamento e design ao serviço da fiabilidade

Para a Beta, design não significa apenas aparência, mas acima de tudo um excelente desempenho. O estudo e design de uma ferramenta destinam-se a garantir a segurança, robustez e facilidade de utilização. É por isso que o design da ferramenta é baseado nas necessidades de utilização : funcionalidade leva a aparência e o design torna-se o resultado final de um estudo detalhado de materiais e acabamentos.

Com este objectivo em mente, a Beta renova constantemente o design dos seus produtos, revendo os seus componentes e materiais

*Inovação
e qualidade: directrizes
para o desenvolvimento de
todos os novos projectos Beta.*



Beta
INOX
STAINLESS STEEL



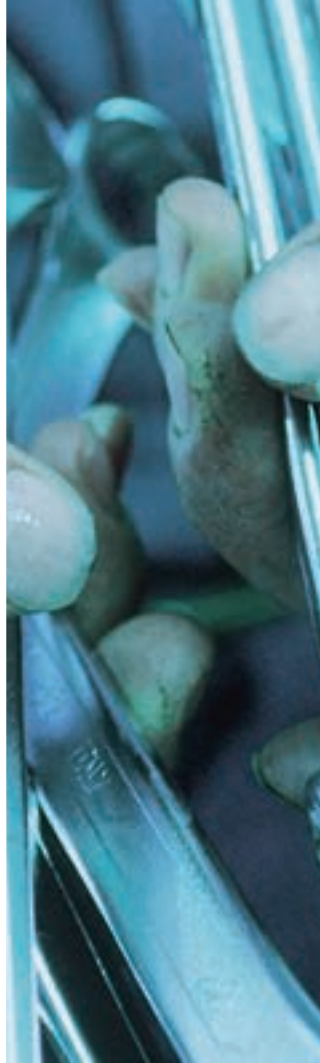

CONTROLO E QUALIDADE



Qualidade Beta, A nossa prova mais concreta

Na Beta, a qualidade tem um significado simples e concreto: “aquilo que satisfaz plenamente as necessidades e expectativas dos utilizadores profissionais que dependem dos nossos produtos como um instrumento de trabalho insubstituível”. As ferramentas não são apenas concebidas e fabricadas para satisfazer apenas uma necessidade, mas para garantir performances consistentes ao longo do tempo.

Na Beta, a qualidade significa mais do que uma mera política de fabrico e vendas atenta, englobando todos os departamentos da empresa no sentido de atingir metas cada vez mais ambiciosas em termos de satisfação do cliente. A Beta tem construído a sua história com base neste mesmo conceito.

A qualidade das ferramentas Beta é uma sinergia entre técnicas tradicionais e novas tecnologias.



Desde 1995 os nossos processos de produção
têm respeitado os padrões
do Sistema de Qualidade
ISO 9001

GAMA DE PRODUTOS

Mais de 12,000 referências

O dinamismo da empresa tem, ao longo dos anos, ajudado a actualizar de forma eficaz a sua gama de produtos para responder prontamente aos desafios do mercado global.

Actualmente a gama Beta Utensili inclui mais de 12,000 referências divididas em 26 famílias de produtos, tornando-a um dos nomes mais sonantes no mercado de ferramentas.

A Beta produz ferramentas para profissionais, desde a manutenção industrial à reparação de veículos, e para todos aqueles cujos hobbies são muito mais do que um simples passatempo.

26

famílias

*Cada necessidade
profissional encontra
uma solução eficaz*

Aplicações



Automóvel



Energia



Indústria



Petrolífera & Gás



Aeronáutica

www.beta-tools.com



Um site “fácil” e completo onde poderá encontrar os nossos catálogos actualizados, as últimas notícias, promoções e todas as informações técnicas (manuais de instruções, peças de substituição e vídeos de demonstração, que também pode encontrar no YouTube)



Uma aplicação específica de todos os catálogos Beta para Ipad e Android.



Autopromotec
2017

APOIO ÀS VENDAS

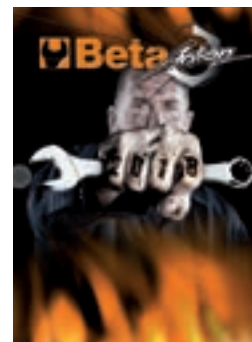

A Beta dispõe de diferentes tipos de expositores oferecendo aos seus clientes soluções prontas a utilizar.



DISTRIBUIÇÃO MUNDIAL



Presente em mais de **100 países** em todo o mundo



8 Subsidiárias

Beta Brasil



Beta Benelux



Beta China



Beta France



Beta Iberia



Beta Polska



Beta UK



Beta Hungary





LOGÍSTICA

**15,000 m²
de superfície**

**Entregas
rápidas,
precisas e completas**



12.000
referências
e mais de **20.000**
unidades de carga



MOBILIÁRIO PARA OFICINA



RSCSS

☐ 330÷349

JOGOS DE FERRAMENTAS E MALAS



☐ 266÷325

☐ 350÷435

CHAVES DE CAIXA E ACESSÓRIOS



☐ 18÷24

☐ 29÷32

☐ 95÷98

CHAVES DE CAIXA E ACESSÓRIOS

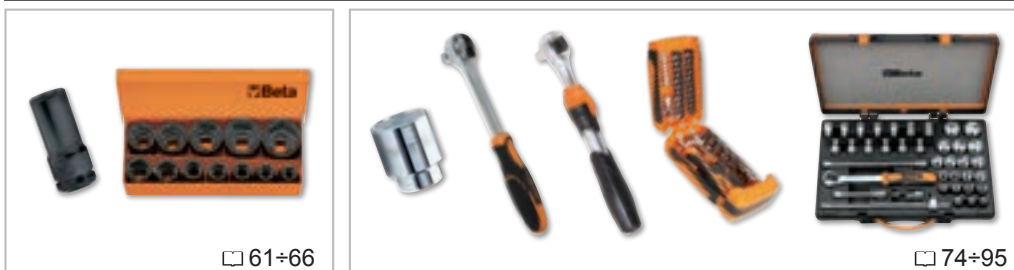

☐ 61÷66

☐ 74÷95

CHAVES DINAMOMÉTRICAS E MULTIPLICADORES DE BINÁRIO

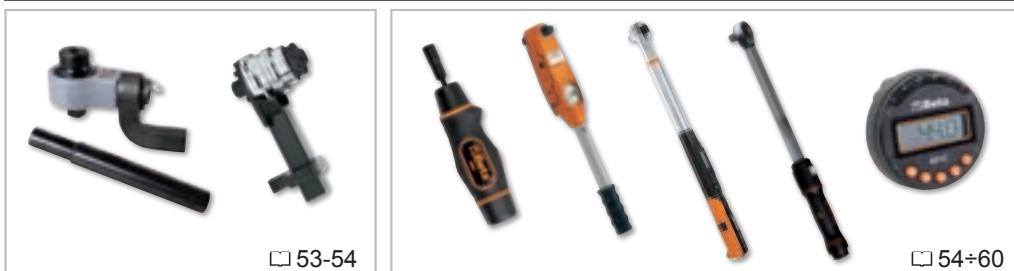

☐ 53-54

☐ 54÷60



CHAVES DE PARAFUSOS, CHAVES EXTREMIDADE MACHO E PONTAS



ALICATES E ALICATES DE CORTE



MARTELOS E CINZÉIS



FERRAMENTAS DE FURAR E ROSCAR



EXTRACTORES





FERRAMENTAS DE MEDIR E TRAÇAR



☐ 178÷184



FERRAMENTAS DE CORTE E MANUTENÇÃO GERAL



☐ 103-104

☐ 111÷115

☐ 130

☐ 193

☐ 174

☐ 185÷194

☐ 200÷210



FERRAMENTAS PARA CANALIZADORES



☐ 32÷38



ELECTRÓNICA E MICROMECAÂNICA



☐ 106÷107

☐ 118÷120

☐ 122÷125

☐ 202÷203



ELECTROTÉCNICA



☐ 115÷117

☐ 123

☐ 174÷177

☐ 196÷198



FERRAMENTAS ISOLADAS 1000V



☐ 240÷243



FERRAMENTAS EM AÇO INOX

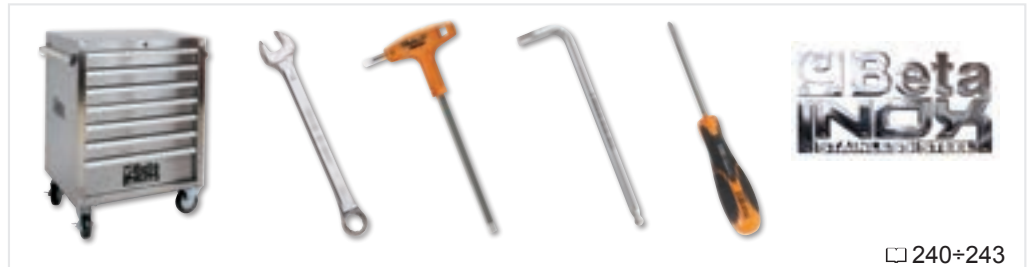

☐ 240÷243



FERRAMENTAS ANTI-FAÍSCA



☐ 244÷251

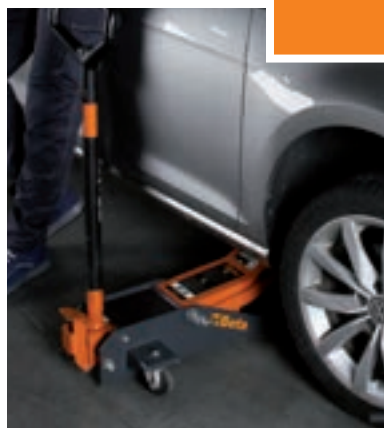

REPARAÇÃO DE VEÍCULOS



☐ 97÷106

☐ 140÷165

☐ 131÷136

☐ 196÷198

☐ 210÷218



FERRAMENTAS PARA MOTOCICLOS



☐ 219÷223



FERRAMENTAS PARA BICICLETAS



☐ 224÷227



FERRAMENTAS PNEUMÁTICAS E ACESSÓRIOS



☐ 254÷271



FERRAMENTAS SEM FIO



☐ 252-253



FERRAMENTAS ANTI-QUEDA



☐ 233÷239



ROBUR ACESSÓRIOS PARA CABOS

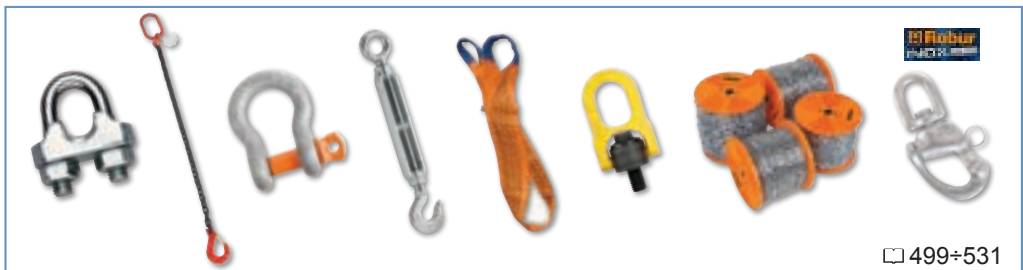

☐ 499÷531



CALÇADO DE SEGURANÇA (E MEIAS TÉCNICAS)



☐ 460÷484



VESTUÁRIO DE TRABALHO



☐ 485÷498



EXPOSITORES PARA PONTOS DE VENDA

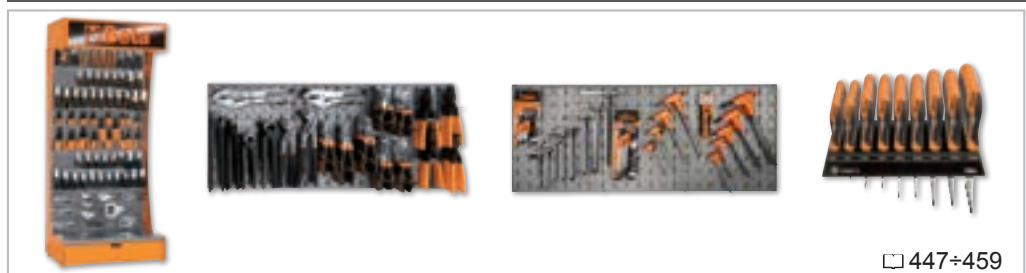

☐ 447÷459



GAMA BLISTER



☐ 435÷446



BETACOLLECTION



☐ 532÷541

GUIA DE LEITURA

Referência

42INOX

Perfil da ferramenta



chave boca/luneta
em aço inox

em blister



Preço unitário



Ferramentas
para motociclos



Ferramentas
para bicicletas



★ artigo disponível a pedido

• tamanho principal

○ encabadouro sextavado

Dimensão

Quantidade por caixa

Quantidade de peças
por jogo

Símbolo da embalagem

Conteúdo da série

mm	L mm	€	Q	Código
6x6	95	12,60	2	000420306
7x7	105	12,90	2	000420307
8x8	116	13,10	2	000420308
9x9	127	14,20	2	000420309
10x10	137	15,10	2	000420310
11x11	148	15,90	2	000420311
12x12	158	16,60	2	000420312
13x13	169	16,80	2	000420313
14x14	180	17,40	2	000420314
15x15	190	18,00	2	000420315
16x16	201	18,60	2	000420316
17x17	212	20,80	2	000420317
18x18	222	22,40	2	000420318
19x19	233	24,00	2	000420319
21x21	254	30,00	1	000420321
22x22	264	31,50	1	000420322
24x24	285	34,00	1	000420324

Novidade 2019



Código

42INOX/S11 6-8-10-11-12-13- 14-15-16-17-19 mm	€ 189,00	Q 1	Código 000420391
---	----------	-----	------------------

Significado dos símbolos mais usados

Exemplo

● Em jogos

B	= Em bolsa plástica	42/B9
BV	= Bolsa plástica vazia	42/BV9
C	= Em caixa metálica	900/C11
D	= Em caixa expositora	1293/D6
S	= Em caixa de cartão	42/S17
SP	= Em expositor	42/SP17
SPV	= Expositor vazio	42/SPV1
SC	= com suporte compacto	96/SC9
SCV	= suporte compacto, vazio	96/SC9

Assortments

AS	= Com ferramentas em polegadas	5915VU/AS
E	= Para electrónica/electrotécnica	5980ET/A
I	= Para a hidráulica	5980ID
MT	= Para movimentação de terras	5902MT
U	= Para reparação universais	5915VU3
SBK	= Para reparação de motociclos	5940SBK
VG	= Para reparação auto	5904VG/5T
VI	= Para manutenção industrial	5902VI

Em chaves de caixa

A	= Perfil de 6 faces	910A
B	= Perfil de 12 faces	910B
ES	= Perfil dentado	920ES
FTX	= Parafusos TORX®	910FTX

Significado dos símbolos mais usados

Exemplo

PT	= Para parafusos com cabeça de 5 nervuras	910PT
X	= Roquete reversível em caixa metálica	920A/C12X

Em chaves para parafusos e pontas para aparafusadoras

LP	= Para parafusos de fenda	920LP
PE	= Para parafusos hexagonais	920PE
PH	= Para parafusos PHILLIPS®	920PH
PZ	= Para parafusos POZIDRIV® - SUPADRIV®	1299PZ
RTX	= Para parafusos TAMPER RESISTANT TORX®	1298RTX
SP	= Para parafusos SPANNER	861SP
TRW	= Para parafusos TRI-WING®	861TRW
TQS	= Para parafusos TORQ-SET®	861TQS
TX	= Para parafusos TORX®	920TX
XZN	= Para parafusos XZN®	920XZN

Na generalidade

AS	= Medidas em polegadas	42AS
BA	= Ferramenta anti-faísca	42BA
BM	= Punho com dois materiais	1150BM
C	= Caixa metálica vazia	C25
HS	= Ferramentas anti-queda	42HS
INOX	= ferramentas em aço inoxidável	42 INOX
L	= Modelo longo	952L
MQ	= Isolamento até 1000V	1150MQ
MP	= Cromado brilhante	42MP
R	= Peça de reposição	338R

Todas as informações e imagens que aparecem neste catálogo são meramente indicativas e sem qualquer valor contratual. A Beta Utensili reserva-se ao direito de alterar ou actualizar a sua gama de produtos sem aviso prévio, e sem obrigação de efectuar qualquer modificação sobre os modelos vendidos anteriormente.



Beta RECOMENDA

a utilização da ferramenta adequada à tarefa a desempenhar,
respeitando as normas de segurança individual.



30

punções



Ø mm	L mm	€	🔧	📦
2	125	6,40	10	000300020
3	125	6,40	10	000300030
4	150	8,55	10	000300040
5	150	8,55	10	000300050
6	150	8,85	10	000300060

31

saca-troços



Ø mm	L mm	L1 mm	€	🔧	📦
2	110	22	6,35	10	000310002
3	128	35	6,55	10	000310003
4	146	45	8,10	10	000310004
5	164	55	8,55	10	000310005
6	182	65	10,70	5	000310006
8	200	80	11,50	5	000310008
10	220	95	14,40	5	000310010



31/B6



31/SP6

31/B6	58,50	1	000310020
2-3-4-5-6-8 mm			
42/BV6	6,65	1	000420051
31/SP6	60,00	1	000310030
2-3-4-5-6-8 mm			
31/SPV	10,90	1	000310031

31BM

saca-troços com punho



Ø mm	L mm	L1 mm	€	🔧	📦
2	168	42	13,00	2	000310402
3	180	52	13,60	2	000310403
4	191	62	14,70	2	000310404
5	200	72	15,30	2	000310405
6	221	82	17,80	2	000310406
8	235	94	18,60	2	000310408



31BM/D6	93,00	1	000310420
2-3-4-5-6-8 mm			

31L

saca-troços série longa



Ø mm	L mm	L1 mm	€	🔧	📦
4	175	80	9,60	5	000310104
5	175	80	10,20	5	000310105
6	175	80	12,30	5	000310106

31SE

saca-troços para cavilhas elásticas



Ø mm	D mm	L mm	L1 mm	€	🔧	📦
4	2,4	175	80	9,60	5	000310204
5	3,0	175	80	10,20	5	000310205
6	3,6	175	80	12,30	5	000310206



31/B6-LSE	71,50	1	000310320
31L: 4-5-6 mm			
31SE: 4-5-6 mm			
55/BV6	7,35	1	000550151

32

punções de bico



Ø mm	L mm	L1 mm	€	🔧	📦
3	100	44	5,90	10	000320100
4	125	52	7,20	10	000320125
5	150	62	8,95	10	000320150

32AU

punção de bico automático



Ø mm	L mm	L1 mm	€	🔧	📦
3	150	23	49,50	2	000320160

32AUR

ponteira de substituição



Ø mm	€	🔧	📦
3	8,75	5	000320170

34

escopros planos



L mm	A mm	L1 mm	€	🔧	📦
125	14,5	45	8,95	5	000340001
150	17,0	58	11,90	5	000340002
175	21,5	68	16,90	5	000340003

35

escopros planos série nervurada



L mm	A mm	€	🔧	📦
100	14,5	10,50	5	000350001
125	17,0	11,80	5	000350002
150	20,5	14,80	5	000350003
200	23,0	22,40	5	000350004
250	28,5	32,50	2	000350005
300	34,0	44,00	2	000350006

35PM

escopros planos série nervurada com punho de protecção



L mm	A mm	€	🔧	📦
200	23,0	33,50	2	000350014
250	28,5	43,50	2	000350015
300	34,0	56,00	2	000350016

35PMR

punhos de protecção



L mm	€	🔧	📦
200	10,90	1	000350024
250	10,90	1	000350025
300	12,00	1	000350026

36

buris série normal



L mm	A mm	L1 mm	€	🔧	📄
125	4	44	9,30	5	000360001
150	6	53	10,90	5	000360002

37

buris série nervurada



L mm	A mm	L1 mm	€	🔧	📄
150	6	45	16,90	5	000370001
200	8	55	24,60	3	000370002

37PM

buril nervurado com punho de protecção



L mm	A mm	€	🔧	📄
200	8	37,00	2	000370012

37PMR

punho de protecção de substituição



L mm	€	🔧	📄
200	12,00	1	000370022



38/B6



38/SP6

Model	€	🔧	📄
38/B6	58,50	1	000380006
30: 2-3 mm			
32: 4 mm			
34: 125-150 mm			
36: 150 mm			
42/BV6	6,65	1	000420051
38/SP6	60,00	1	000380009
30: 2-3 mm			
32: 4 mm			
34: 125-150 mm			
36: 150 mm			
38/SPV	10,90	1	000380019

42

chaves mistas boca/luneta



DIN 3113 UNI-ISO 7738

🔧	L mm	€	🔧	📄
5,5x5,5	95	6,55	5	000420005
6x6	95	6,65	5	000420006
7x7	105	6,70	5	000420007
8x8	116	6,85	5	000420008
9x9	127	7,15	5	000420009
10x10	137	7,30	5	000420010
11x11	148	7,80	5	000420011
12x12	158	7,90	5	000420012
13x13	169	8,00	5	000420013
14x14	180	9,30	5	000420014
15x15	190	10,20	5	000420015
16x16	201	10,50	5	000420016
17x17	212	10,90	5	000420017
18x18	222	11,80	5	000420018
19x19	233	12,00	5	000420019
20x20	243	13,70	3	000420020
21x21	254	14,80	3	000420021
22x22	264	15,10	3	000420022
23x23	275	16,50	3	000420023
24x24	285	16,80	3	000420024
25x25	296	18,50	2	000420025
26x26	307	19,90	2	000420026
27x27	317	21,50	2	000420027
28x28	328	22,50	2	000420028
29x29	338	24,20	2	000420029
30x30	349	25,00	2	000420030
32x32	370	27,50	2	000420032
34x34	391	57,50	1	000420034
35x35	412	62,50	1	000420035
36x36	412	65,00	1	000420036
38x38	433	71,50	1	000420038
41x41	465	80,00	1	000420041



Model	€	🔧	📄
42/B9	83,00	1	000420064
6-7-8-10-11-13-14-17-19 mm			
42/BV9	8,40	1	000420056



Model	€	🔧	📄
42/S14	136,00	1	000420067
6-7-8-10-11-12-13-14-15-16-17-19-22-24 mm			
42/S15	190,00	1	000420066
6-7-8-10-11-12-13-14-17-19-22-24-27-30-32 mm			
42/S17	167,00	1	000420065
6-7-8-9-10-11-12-13-14-15-16-17-18-19-20-21-22 mm			
42/S17X	198,00	1	000420068
6-7-8-10-11-12-13-14-15-16-17-19-21-22-24-27-30 mm			
42/S26	359,00	1	000420070
6-7-8-9-10-11-12-13-14-15-16-17-18-19-20-21-22-23-24-25-26-27-28-29-30-32 mm			

42/SC9I-E

jogo de 9 chaves mistas, boca luneta, com suporte compacto



Model	€	🔧	📄
42/SC9I	87,00	1	000420087
8-10-11-12-13-14-15-17-19 mm			
42/SCV9I	8,95	1	000420103
42/SC9E	89,50	1	000420088
8-10-11-12-13-16-17-18-19 mm			
42/SCV9E	8,95	1	000420104



Model	€	🔧	📄
42/SP25	373,00	1	000420085
6-7-8-9-10-11-12-13-14-15-16-17-18-19-20-21-22-23-24-25-26-27-28-30-32 mm			
42/SPV2	41,50	1	000420090



42/SP15

42/SPV...

Model	€	🔧	📄
42/SP15	148,00	1	000420078
6-7-8-9-10-11-12-13-14-15-16-17-19-22-24 mm			
42/SPV7	6,15	1	000420097
42: 8-10-11-13-14-17-19 mm			
55: 6x7-8x9-10x11-12x13-14x15-16x17-18x19 mm			
42/SPV11	8,95	1	000420100
42MP: 8-9-10-11-12-13-14-15-16-17-19 mm			
142-142SN: 8-9-10-11-12-13-14-15-16-17-19 mm			
42/SPV15	12,40	1	000420102
42: 6-7-8-9-10-11-12-13-14-15-16-17-19-22-24 mm			

42AS

chaves mistas boca/luneta



mm	L mm	€	U	PC
1/4x1/4	95	8,00	2	000420106
9/32X9/32	106	8,10	2	000420107
5/16x5/16	116	8,20	2	000420108
3/8x3/8	137	8,80	2	000420110
7/16x7/16	148	9,60	2	000420111
1/2x1/2	169	9,90	2	000420113
9/16x9/16	180	10,80	2	000420114
19/32X19/32	191	12,10	2	000420115
5/8x5/8	201	12,70	2	000420116
11/16x11/16	212	13,50	2	000420117
3/4x3/4	233	14,50	2	000420119
13/16x13/16	254	17,10	2	000420121
7/8x7/8	264	17,70	2	000420122
15/16x15/16	285	20,20	2	000420124
1x1	296	21,30	2	000420125
1.1/16x1.1/16	317	23,30	2	000420127
1.1/8x1.1/8	338	25,50	2	000420129
1.1/4x1.1/4	370	32,00	2	000420132
1.5/16x1.5/16	391	59,00	1	000420133
1.3/8x1.3/8	412	68,00	1	000420135
1.7/16x1.7/16	412	70,00	1	000420136
1.1/2x1.1/2	433	74,50	1	000420138



42AS/B9	103,50	U	PC
1/4-5/16-3/8-7/16-1/2		1	000420155
9/16-5/8-11/16-3/4			



42AS/13	173,00	U	PC
1/4-5/16-3/8-7/16-1/2-9/16-5/8		1	000420163
11/16-3/4-13/16-7/8-15/16-1			
42AS/16	253,00	U	PC
1/4-5/16-3/8-7/16-1/2-9/16-5/8		1	000420166
11/16-3/4-13/16-7/8-15/16-1			
1.1/16-1.1/8-1.1/4			
42AS/17	241,00	U	PC
1/4-9/32-5/16-3/8-7/16-1/2-		1	000420168
9/16-19/32-5/8-11/16-3/4-			
13/16-7/8-15/16-1-1.1/16-1.1/8			

42MP

chaves mistas boca/luneta em cromado brilhante



DIN 3113 UNI-ISO 7738

mm	L mm	€	U	PC
6x6	95	10,90	5	000420606
7x7	105	11,00	5	000420607
8x8	116	11,10	5	000420608
9x9	127	11,20	5	000420609
10x10	137	11,30	5	000420610
11x11	148	11,40	5	000420611
12x12	158	11,50	5	000420612
13x13	169	11,60	5	000420613
14x14	180	12,50	5	000420614
15x15	190	13,70	5	000420615
16x16	201	14,50	5	000420616
17x17	212	15,00	5	000420617
18x18	222	16,30	5	000420618
19x19	233	16,50	5	000420619
20x20	243	19,30	3	000420620
21x21	254	20,00	3	000420621
22x22	264	20,50	3	000420622
24x24	285	23,00	3	000420624
27x27	317	28,00	3	000420627
30x30	349	34,50	3	000420630
32x32	370	36,50	3	000420632



42MP/B9	119,00	U	PC
6-7-8-10-11-13-14-17-19 mm		1	000420651
42/BV9	8,40	U	PC
		1	000420056

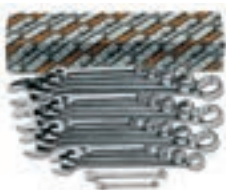

42MP/S17	238,00	U	PC
6-7-8-9-10-11-12-13-14-15		1	000420652
16-17-18-19-20-21-22 mm			
42MP/S21	360,00	U	PC
6-7-8-9-10-11-12-13-14		1	000420653
15-16-17-18-19-20-21-22			
24-27-30-32 mm			

42LMP

chaves mistas boca/luneta série longa em cromado brilhante



mm	L mm	€	U	PC
8x8	148	9,75	2	000420508
9x9	167	10,10	2	000420509
10x10	172	10,40	2	000420510
11x11	186	10,90	2	000420511
12x12	197	11,20	2	000420512
13x13	207	11,40	2	000420513
14x14	223	12,20	2	000420514
15x15	233	13,40	2	000420515

mm	L mm	€	U	PC
16x16	243	14,40	2	000420516
17x17	261	15,40	2	000420517
18x18	270	16,70	2	000420518
19x19	280	17,20	2	000420519
21x21	301	19,90	2	000420521
22x22	318	20,40	2	000420522
24x24	338	23,70	2	000420524
27x27	376	27,50	2	000420527
30x30	394	34,50	2	000420530
32x32	435	38,00	2	000420532



42LMP/S14	193,00	U	PC
8-9-10-11-12-13-14		1	000420551
15-16-17-18-19-21-22 mm			
42LMP/S18	316,00	U	PC
8-9-10-11-12-13-14		1	000420552
15-16-17-18-19-21-22			
24-27-30-32 mm			

45

chaves mistas boca/luneta serviço pesado



DIN 3113 UNI-ISO 7738

mm	L mm	€	U	PC
46x46	520	197,00	1	000450046
50x50	560	229,00	1	000450050
55x55	610	326,00	1	000450055
60x60	660	444,00	1	000450060
65x65	710	522,00	1	000450065
70x70	760	584,00	1	000450070
75x75	810	663,00	1	000450075
80x80	860	797,00	1	000450080

52

chaves de boca simples



UNI 6733 DIN 3114

mm	L mm	€	U	PC
10	119	8,55	5	000520010
11	119	8,75	5	000520011
12	119	9,30	5	000520012
13	145	10,40	5	000520013
14	145	10,60	5	000520014
15	145	10,90	5	000520015
16	159	11,60	5	000520016
17	159	11,60	5	000520017
18	159	12,60	5	000520018
19	175	13,70	5	000520019
20	175	14,80	5	000520020
21	175	15,30	5	000520021
22	196	16,90	2	000520022
23	196	17,50	2	000520023
24	196	18,00	2	000520024
25	215	20,20	2	000520025
26	215	20,50	2	000520026
27	215	20,80	2	000520027
28	240	24,00	2	000520028
30	240	24,90	2	000520030
32	270	29,00	2	000520032



mm	L mm	€		
34	270	32,50	1	000520034
35	295	36,00	1	000520035
36	295	36,00	1	000520036
38	295	41,50	1	000520038
40	335	51,00	1	000520040
41	335	51,00	1	000520041
42	335	56,00	1	000520042
45	370	63,50	1	000520045
46	370	63,50	1	000520046
48	370	75,00	1	000520048
50	415	87,00	1	000520050
52	415	97,50	1	000520052
55	415	101,50	1	000520055
60	490	125,00	1	000520060
65	490	129,00	1	000520065
70	490	142,00	1	000520070

53

chaves de boca simples DIN 894



mm	L mm	€		
36	317	27,00	1	000530036
38	320	29,00	1	000530038
41	342	34,50	1	000530041
46	396	42,00	1	000530046
50	412	64,50	1	000530050
55	457	74,50	1	000530055
60	492	92,00	1	000530060
65	528	109,00	1	000530065
70	572	126,00	1	000530070
75	608	157,00	1	000530075
80	645	193,00	1	000530080
85	690	235,00	1	000530085
90	690	277,00	1	000530090
95	847	387,00	1	000530095
100	847	409,00	1	000530100
105	1000	507,00	1	000530105
110	1000	545,00	1	000530110
115	1000	611,00	1	000530115
120	1000	698,00	1	000530120
125	1000	807,00	1	000530125
130	1000	872,00	1	000530130
135	1000	927,00	1	000530135

55

chaves de bocas



UNI-ISO 10102 DIN 3110

mm	L mm	€		
4x5	101	4,20	5	000550003
5x5,5	101	4,80	5	000550006
5,5x7	120	4,80	5	000550009
6x7	120	3,70	5	000550012
7x8	140	4,80	5	000550018
8x9	140	3,80	5	000550021
8x10	140	4,80	5	000550024
10x11	155	4,05	5	000550030
10x12	155	5,50	5	000550033
10x13	170	6,05	5	000550035
12x13	170	4,50	5	000550042
12x14	170	6,25	5	000550045
13x14	185	6,95	5	000550047
13x17	189	7,40	5	000550051
14x15	185	5,70	5	000550054
14x17	189	8,05	5	000550057
16x17	202	6,40	5	000550060
17x19	220	8,75	2	000550063
18x19	220	7,65	2	000550066
19x22	236	10,10	2	000550069
20x22	236	8,65	2	000550075
21x23	245	9,40	2	000550078
22x24	245	10,90	2	000550081

mm	L mm	€		
24x26	262	10,90	2	000550087
24x27	262	12,30	2	000550090
25x28	272	12,60	2	000550096
27x29	284	14,40	2	000550099
27x30	284	16,70	2	000550102
27x32	297	18,00	2	000550105
30x32	297	15,80	2	000550108
32x36	325	60,00	1	000550114
34x36	325	60,00	1	000550117
35x38	375	66,50	1	000550120
36x41	375	69,00	1	000550123
41x46	425	80,00	1	000550129
46x50	475	98,50	1	000550132
50x55	500	115,00	1	000550135
55x60	500	124,00	1	000550138



	€		
55/B8 6x7-8x9-10x11-12x13 14x15-16x17-18x19 20x22 mm	51,50	1	000550158
55/BV8	8,40	1	000550159
55/B12 6x7-8x9-10x11-12x13 14x15-16x17-18x19 20x22-21x23-24x26 25x28-30x32 mm	104,00	1	000550162
55/BV12	13,70	1	000550163



	€		
55/S8 6x7-8x9-10x11-12x13 14x15-16x17-18x19 20x22 mm	44,50	1	000550174
55/S12 6x7-8x9-10x11-12x13 14x15-16x17-18x19 20x22-21x23-24x26 25x28-30x32 mm	93,00	1	000550178
55/S12X 6x7-8x9-10x11-12x13 14x15-16x17-18x19 20x22-21x23-24x27 25x28-30x32 mm	94,50	1	000550179
55/S13 6x7-8x9-10x11-12x13 14x15-16x17-18x19 20x22-21x23-24x26 25x28-27x29-30x32 mm	108,00	1	000550182



55/SP7



55/SP13

	€		
55/SP7 6x7-8x9-10x11-12x13 14x15-16x17-18x19 mm	38,00	1	000550167
42/SPV7 42: 8-10-11-13-14-17-19 mm 55: 6x7-8x9-10x11-12x13 14x15-16x17-18x19 mm	6,15	1	000420097
55/SP13 6x7-8x9-10x11-12x13 14x15-16x17-18x19 20x22-21x23-24x26 25x28-27x29-30x32 mm	130,00	1	000550186
55/SPV 27,00	27,00	1	000550190

55AS

chaves de bocas



	€			
1/4x9/32	120	5,05	2	000550203
1/4x5/16	120	5,05	2	000550206
5/16x11/32	140	5,35	2	000550209
5/16x3/8	140	5,35	2	000550212
3/8x7/16	155	5,80	2	000550215
7/16x1/2	170	6,35	2	000550218
1/2x9/16	170	6,80	2	000550221
9/16x5/8	185	7,65	2	000550224
19/32x11/16	189	9,20	2	000550227
5/8x11/16	202	9,20	2	000550230
5/8x3/4	202	10,40	2	000550233
11/16x13/16	220	10,80	2	000550242
3/4x7/8	236	11,70	2	000550245
25/32x13/16	236	11,70	2	000550244
7/8x15/16	245	12,60	2	000550251
15/16x1	262	15,90	1	000550257
1x1.1/8	272	16,80	1	000550259
1.1/16x1.1/4	284	21,90	1	000550267
1.1/8x1.5/16	297	21,90	1	000550266
1.5/16x1.1/2	325	71,00	1	000550269
1.3/8x1.1/2	375	78,50	1	000550272
1.7/16x1.5/8	375	78,50	1	000550275



	€		
55AS/5 5/16x11/32-3/8x7/16 1/2x9/16-5/8x11/16 3/4x7/8	39,00	1	000550290
55AS/8 1/4x9/32-5/16x11/32-3/8x7/16- 1/2x9/16-9/16x5/8-5/8x11/16- 11/16x13/16-3/4x7/8	62,50	1	000550296
55AS/12 1/4x9/32-5/16x11/32-3/8x7/16-1 2x9/16-9/16x5/8-5/8x11/16- 11/16x13/16-25/32x13/16-3/4x7/8- 15/16x1-1x1.1/8-1.1/16x1.1/4	129,00	1	000550298

 **Beta**

55MP

chaves de bocas
em cromado brilhante



UNI-ISO 10102 DIN 3110

mm	L mm	€	U	U
6x7	120	4,95	2	000550603
8x9	140	5,40	2	000550606
10x11	155	5,85	2	000550609
12x13	170	6,50	2	000550612
14x15	185	7,65	2	000550615
16x17	202	9,00	2	000550618
18x19	220	10,60	2	000550621
20x22	236	12,20	2	000550624
21x23	245	13,10	2	000550627
24x26	262	15,30	1	000550630
25x28	272	16,20	1	000550633
27x29	284	19,40	1	000550636
30x32	297	21,20	1	000550639

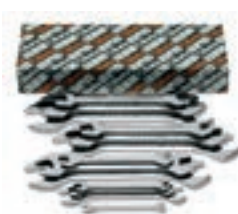

mm	L mm	€	U	U
55MP/S8 6x7-8x9-10x11-12x13 14x15-16x17-18x19 20x22 mm		62,50	1	000550650
55MP/S13 6x7-8x9-10x11-12x13 14x15-16x17-18x19 20x22-21x23-24x26 25x28-27x29-30x32 mm		148,00	1	000550651
55MP/S12 6x7-8x9-10x11-12x13-14x15- 16x17-18x19-20x22-21x23-24x26- 25x28-30x32 mm		128,00	1	000550653

58

chaves de boca, série pancada



DIN 133

mm	L mm	€	U	U
24	177	27,00	1	000580024
27	180	28,50	1	000580027
30	190	32,00	1	000580030
32	190	33,00	1	000580032
34	200	42,00	1	000580034
36	215	43,50	1	000580036
41	235	52,00	1	000580041
46	255	69,50	1	000580046
50	275	77,00	1	000580050
55	300	92,50	1	000580055
60	320	101,50	1	000580060
65	342	132,00	1	000580065
70	375	172,00	1	000580070
75	375	189,00	1	000580075
80	408	265,00	1	000580080
85	408	299,00	1	000580085
90	445	350,00	1	000580090
95	445	361,00	1	000580095
100	485	507,00	1	000580100
105	485	569,00	1	000580105

mm	L mm	€	U	U
110	510	621,00	1	000580110
115	510	716,00	1	000580115
120	545	733,00	1	000580120
125	545	840,00	1	000580125
130	575	1.123,00	1	000580130
135	575	1.183,00	1	000580135
*140	575	1.280,00	1	000580140
*145	640	1.775,00	1	000580145
*150	640	1.830,00	1	000580150
*155	640	1.955,00	1	000580155
*160	640	2.165,00	1	000580160
*165	715	2.335,00	1	000580165
*170	715	3.170,00	1	000580170
*175	715	3.350,00	1	000580175
*180	715	3.630,00	1	000580180
*185	715	3.730,00	1	000580185
*190	800	4.090,00	1	000580190
*195	800	4.320,00	1	000580195
*200	800	4.510,00	1	000580200
*210	800	5.630,00	1	000580210
*220	800	7.350,00	1	000580220
*230	800	9.000,00	1	000580230

73

chaves de bocas
de pequenas dimensões



UNI 6737

mm	L mm	€	U	U
4x4	78	7,65	5	000730040
4,5x4,5	78	7,65	5	000730045
5x5	78	7,65	5	000730050
5,5x5,5	86	8,35	5	000730055
6x6	86	8,35	5	000730060
7x7	86	8,35	5	000730070
8x8	97	8,70	5	000730080
9x9	97	8,70	5	000730090
10x10	108	9,30	5	000730100
11x11	108	9,30	5	000730110
12x12	124	10,70	5	000730120
13x13	124	10,70	5	000730130
14x14	124	10,70	5	000730140



mm	L mm	€	U	U
73/B13 4-4,5-5-5,5-6-7-8-9 10-11-12-13-14 mm		124,00	1	000730200
73/BV		7,85	1	000730201

mm	L mm	€	U	U
73/S13 4-4,5-5-5,5-6-7-8-9 10-11-12-13-14 mm		116,00	1	000730210

 **Beta**

78

chaves de luneta de 12 faces
série pancada



DIN 7444

mm	L mm	€	U	U
24	162	28,00	1	000780024
27	180	33,00	1	000780027
30	190	39,50	1	000780030
32	190	40,50	1	000780032
36	205	51,50	1	000780036
41	225	66,00	1	000780041
46	235	75,00	1	000780046
50	250	88,00	1	000780050
55	265	100,50	1	000780055
60	275	121,00	1	000780060
65	295	155,00	1	000780065
70	325	158,00	1	000780070
75	325	187,00	1	000780075
80	350	283,00	1	000780080
85	350	307,00	1	000780085
90	390	375,00	1	000780090
95	390	434,00	1	000780095
100	420	491,00	1	000780100
105	420	564,00	1	000780105
110	450	626,00	1	000780110
115	450	709,00	1	000780115
120	490	992,00	1	000780120
125	480	1.330,00	1	000780125
130	520	1.525,00	1	000780130
135	520	1.650,00	1	000780135
*140	520	1.885,00	1	000780140
*145	580	2.370,00	1	000780145
*150	580	2.480,00	1	000780150
*155	580	2.780,00	1	000780155
*160	650	2.860,00	1	000780160
*165	650	3.060,00	1	000780165
*170	650	3.730,00	1	000780170
*175	650	4.030,00	1	000780175
*180	650	4.400,00	1	000780180
*185	695	4.550,00	1	000780185
*190	695	4.870,00	1	000780190
*195	695	4.920,00	1	000780195
*200	695	5.040,00	1	000780200
*210	740	5.320,00	1	000780210
*215	740	6.030,00	1	000780215
*220	740	6.680,00	1	000780220
*230	740	8.310,00	1	000780230

78AS

chave de luneta de pancada



mm	L mm	€	U	U
*1.1/16	180	39,50	1	000780327
*1.1/8	190	39,50	1	000780329
*1.3/16	190	39,50	1	000780330
*1.1/4	197	43,50	1	000780332
*1.5/16	197	43,50	1	000780333
*1.3/8	223	47,50	1	000780335
*1.7/16	223	57,00	1	000780336
*1.1/2	223	57,00	1	000780338
*1.5/8	223	66,50	1	000780341
*1.11/16	225	70,00	1	000780343
*1.13/16	240	77,00	1	000780346
*1.7/8	250	77,00	1	000780348
*2	250	89,50	1	000780350
*2.1/16	250	93,00	1	000780352
*2.3/16	275	97,50	1	000780355
*2.3/8	270	130,00	1	000780360
*2.9/16	302	145,00	1	000780365
*2.3/4	350	156,00	1	000780370
*2.15/16	350	179,00	1	000780375
*3.1/8	354	294,00	1	000780380

80

chaves de caixa articuladas com 12 faces



mm	L mm	€	U	U
6x7	170	31,50	3	000800006
8x9	176	31,50	3	000800008
8x10	179	31,50	3	000800009
10x11	182	33,50	3	000800010
12x13	228	37,50	3	000800012
14x15	232	38,50	3	000800014
13x17	231	41,00	3	000800015
16x17	234	41,00	2	000800016
18x19	285	50,00	2	000800018
19x22	287	52,00	2	000800019
20x22	289	52,00	2	000800020
21x23	289	53,00	2	000800021
24x27	405	87,50	2	000800024
30x32	413	93,00	2	000800030

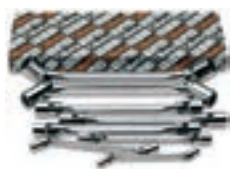

€	U	U
80/S8	313,00	1 000800051
6x7-8x9-10x11-12x13-14x15-16x17-18x19-20x22 mm		
80/S11	545,00	1 000800056
6x7-8x9-10x11-12x13-14x15-16x17-18x19-20x22-21x23-24x27-30x32 mm		

83

chaves curvas de lunetas para motores de arranque



ISO 3318

mm	L mm	€	U	U
8x10	126	14,80	3	000830008
10x12	137	15,30	3	000830010
11x13	138	15,90	3	000830011
14x17	183	20,20	3	000830014
15x17	184	22,90	2	000830015
16x18	196	25,00	2	000830016
19x22	231	33,00	2	000830019



€	U	U
83/S3	69,00	1 000830081
11x13-14x17-19x22 mm		
83/S5	112,00	1 000830085
10x12-11x13-15x17-16x18-19x22 mm		

83AS

chaves curvas de lunetas para motores de arranque



mm	L mm	€	U	U
7/16x1/2	138	19,10	2	000830111
9/16x5/8	183	22,90	2	000830114
3/4x7/8	230	36,00	2	000830119



€	U	U
83AS/3	78,00	1 000830181
7/16x1/2-9/16x5/8-3/4x7/8		

88

chaves de luneta duplas direitas, série extralonga



mm	L mm	€	U	U
8x10	235	16,90	2	000880008
12x14	330	20,20	2	000880012
13x15	330	20,20	2	000880013
16x18	405	28,50	2	000880016
17x19	405	28,50	2	000880017
21x23	435	33,00	2	000880021
22x24	435	33,00	2	000880022



€	U	U
88/S7	179,00	1 000880107
8x10-12x14-13x15-16x18-17x19-21x23-22x24 mm		

90

chaves de lunetas com curvatura profunda



DIN 838 ISO 10104

mm	L mm	€	U	U
6x7	165	8,75	5	000900006
8x9	180	9,40	5	000900012
8x10	180	10,90	5	000900015
10x11	195	10,20	5	000900018
10x12	195	11,20	5	000900021
11x13	215	12,40	5	000900024
12x13	215	11,30	5	000900027
12x14	215	12,90	5	000900030
14x15	230	12,00	5	000900033
14x17	250	15,30	5	000900036
16x17	250	14,10	5	000900039
17x19	265	18,10	5	000900042
18x19	265	16,40	5	000900045
19x22	285	20,40	3	000900048
20x22	285	18,60	3	000900051
21x23	305	21,00	2	000900057
22x24	305	23,20	2	000900060
24x26	325	23,70	2	000900063
24x27	325	26,00	2	000900067
25x28	340	28,50	2	000900070
27x29	355	31,00	2	000900073
27x30	355	34,00	2	000900076
27x32	375	37,50	2	000900078
30x32	375	34,00	2	000900080
32x36	395	51,50	1	000900088
34x36	415	60,00	1	000900089
35x38	415	60,50	1	000900091
36x41	435	69,00	1	000900094
41x46	460	101,50	1	000900097
46x50	500	137,00	1	000900100



€	U	U
90/B8	112,00	1 000900154
6x7-8x9-10x11-12x13-14x15-16x17-18x19-20x22 mm		
90/BV8	11,50	1 000900155

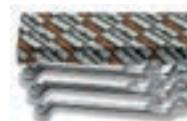

€	U	U
90/S8	100,50	1 000900162
6x7-8x9-10x11-12x13-14x15-16x17-18x19-20x22 mm		
90/S12	208,00	1 000900166
6x7-8x9-10x11-12x13-14x15-16x17-18x19-20x22-21x23-24x26-25x28-30x32 mm		
90/S12X	210,00	1 000900167
6x7-8x9-10x11-12x13-14x15-16x17-18x19-20x22-21x23-24x27-25x28-30x32 mm		
90/S13	238,00	1 000900170
6x7-8x9-10x11-12x13-14x15-16x17-18x19-20x22-21x23-24x26-25x28-27x29-30x32 mm		

 **Beta**



90/SP13	€ 265,00	1	000900174
6x7-8x9-10x11-12x13			
14x15-16x17-18x19			
20x22-21x23-24x26			
25x28-27x29-30x32 mm			
55/SPV	€ 27,00	1	000550190

90AS

chaves de lunetas com curvatura profunda



mm	L mm	€		
1/4x5/16	165	10,30	2	000900203
5/16x11/32	180	10,90	2	000900206
5/16x3/8	180	11,30	2	000900209
3/8x7/16	195	11,50	2	000900212
7/16x1/2	215	12,90	2	000900215
1/2x9/16	230	14,80	2	000900218
9/16x5/8	230	14,80	2	000900221
19/32x11/16	250	16,10	2	000900222
5/8x11/16	250	16,60	2	000900224
5/8x3/4	265	19,50	2	000900227
11/16x3/4	265	19,50	1	000900230
11/16x13/16	265	19,50	1	000900233
3/4x25/32	265	22,40	1	000900235
3/4x7/8	285	22,40	1	000900237
13/16x7/8	285	22,90	1	000900240
7/8x15/16	305	22,90	1	000900243
15/16x1	325	27,50	1	000900252
1.1/16x1.1/4	375	40,00	1	000900258
1.1/8x1.5/16	375	40,00	1	000900261



90AS/8	€ 134,00	1	000900298
1/4x5/16-5/16x11/32			
3/8x7/16-1/2x9/16			
5/8x11/16-11/16x3/4			
13/16x7/8-15/16x1			
90AS/10	€ 214,00	1	000900300
1/4x5/16-5/16x11/32			
3/8x7/16-1/2x9/16			
5/8x11/16-11/16x3/4			
13/16x7/8-15/16x1			
1.1/16x1.1/4-1.1/8x1.5/16			

91

chaves de luneta inclinada para serviços pesados



mm	Ø mm	€		
24	38	51,00	1	000910024
27	41	52,00	1	000910027
30	48	56,00	1	000910030
32	49	60,00	1	000910032
36	54	68,50	1	000910036
41	62	82,00	1	000910041
46	69	95,00	1	000910046
50	76	108,50	1	000910050
55	81	120,00	1	000910055
60	90	150,00	1	000910060
65	98	168,00	1	000910065
70	105	190,00	1	000910070
75	110	214,00	1	000910075
80	125	246,00	1	000910080
85	125	257,00	1	000910085
90	140	469,00	1	000910090
95	140	513,00	1	000910095
100	143	542,00	1	000910100
105	146	595,00	1	000910105

92

cabo tubular para a chave ref. 91



L mm	91 mm	Ø mm	€		
92/1	460	24÷30	19	30,00	1 000920010
92/2	610	32÷41	22	46,00	1 000920020
92/3	760	46÷55	25	66,50	1 000920030
92/4	860	60÷105	30	87,50	1 000920040

93

chave de lunetas com curvatura profunda especial para andaimes



mm	L mm	€		
21x22	310	35,00	3	000930021

93C

roquete de dupla face, com curvatura, para parafusos de andaimes



mm	L mm	€		
17x19	310	41,50	1	000930117
19x22	310	45,00	1	000930119
19x24	310	54,00	1	000930120
21x22	365	51,00	1	000930121
36x38	445	84,50	1	000930136

94

chaves de lunetas abertas



DIN 3118

mm	L mm	€		
8x10	140	15,30	2	000940008
9x11	153	16,00	2	000940009
10x11	153	16,50	2	000940010
11x13	175	17,10	2	000940011
12x14	175	18,30	2	000940012
13x15	175	18,30	2	000940013
14x15	175	21,60	2	000940014
14x17	195	22,20	2	000940015
17x19	212	22,70	2	000940017
19x22	228	24,50	2	000940019
22x24	242	30,00	2	000940022
24x27	260	32,50	2	000940024
30x32	300	41,50	2	000940030
36x41	320	68,50	1	000940036



94/S6	€ 114,00	1	000940050
8x10-10x11-11x13-12x14			
17x19-19x22 mm			
94/S10	€ 234,00	1	000940052
8x10-9x11-10x11-11x13			
12x14-17x19-19x22			
22x24-24x27-30x32 mm			

95

chaves de lunetas direitas



DIN 837 ISO 10103

mm	L mm	€		
6x7	120	9,85	3	000950161
8x9	135	10,50	3	000950162
10x11	150	12,00	3	000950163
12x13	165	13,10	3	000950164
14x15	185	13,70	3	000950165
16x17	210	14,80	3	000950166
17x19	225	16,90	3	000950167
18x19	225	16,90	2	000950168
20x22	240	19,20	2	000950169
21x23	255	20,30	2	000950170
24x26	270	21,50	2	000950171
25x28	285	26,00	2	000950172
27x29	315	26,50	2	000950173
30x32	335	30,00	2	000950174



95/S8	€ 110,00	1	000950177
6x7-8x9-10x11-12x13			
14x15-16x17-18x19			
20x22 mm			
95/S13	€ 234,00	1	000950179
6x7-8x9-10x11-12x13			
14x15-16x17-18x19			
20x22-21x23-24x26			
25x28-27x29-30x32 mm			

Beta

95FTX

chaves de lunetas direitas,
para parafusos com perfil Torx®



	L mm	€	📦	🚚
E6xE8	115	10,30	2	000950306
E10xE12	143	10,80	2	000950310
E14xE18	177	12,00	2	000950314
E20xE24	224	16,10	2	000950320

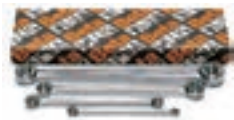

	€	📦	🚚
95FTX/S4 E6xE8-E10xE12 E14xE18-E20xE24	49,50	1	000950325

96

chaves macho hexagonal
cromadas



ISO 2936

mm	L mm	L1 mm	€	📦	🚚
0,9	35	8	0,90	20	000960013
1,3	39	10	0,90	20	000960014
1,5	45	15	0,90	20	000960015
2	50	17	0,95	20	000960020
2,5	57	20	0,95	20	000960025
3	64	22	1,10	20	000960030
3,5	68	25	1,30	20	000960035
4	72	28	1,35	20	000960040
4,5	78	30	1,40	20	000960045
5	83	32	1,50	20	000960050
5,5	88	35	1,80	20	000960055
6	94	37	1,80	20	000960060
7	99	40	2,25	10	000960070
8	105	43	2,65	10	000960080
9	111	46	3,15	10	000960090
10	119	49	3,75	10	000960100
11	126	52	4,60	10	000960110
12	134	56	5,55	10	000960120
13	142	62	7,20	10	000960130
14	151	69	8,40	10	000960140
16	165	75	12,00	5	000960160
17	174	79	13,00	5	000960170
19	196	88	18,00	5	000960190
22	216	100	28,00	3	000960220
24	242	112	37,50	1	000960240
27	271	125	50,50	1	000960270
30	309	140	67,50	1	000960300
32	341	155	89,50	1	000960312
36	385	174	129,00	1	000960316



	€	📦	🚚
96/ST6 2,5-3-4-5-6-8 mm	13,00	3	000960370



	€	📦	🚚
96/BGS7 1,5-2-2,5-3-4-5-6 mm	28,00	1	000960367



	€	📦	🚚
96/BG7 2,5-3-4-5-6-8-10 mm	30,00	1	000960368



	€	📦	🚚
96/B8 2-2,5-3-4-5-6-8-10 mm	15,50	5	000960386
96/B10 1,5-2-2,5-3-4-5-6-8-10-12 mm	22,00	5	000960380
96N/BV	1,65	1	000960651



	€	📦	🚚
96/SC9 1,5-2-2,5-3-4-5-6-8-10 mm	18,60	1	000960374
96/SCV	3,85	1	000960985



	€	📦	🚚
96/SC12 2-2,5-3-3,5-4-4,5-5-5-6-7-8-9-10 mm	26,00	1	000960395
96/SCV12	4,40	1	000960975



96N

chaves macho hexagonal, brunidas



ISO 2936

mm	L mm	L1 mm	€	📦	🚚
0,9	32	10	0,45	20	000960409
1,3	44	12	0,45	20	000960413
1,5	46	15	0,45	20	000960415
2	51	17	0,50	20	000960420
2,5	57	20	0,50	20	000960425
3	64	22	0,55	20	000960430
3,5	68	25	0,70	20	000960435
4	72	28	0,80	20	000960440
4,5	78	30	0,85	20	000960445
5	83	32	0,90	20	000960450
6	94	37	1,10	20	000960460
7	99	40	1,50	10	000960470
8	105	43	1,75	10	000960480
9	111	46	2,30	10	000960490
10	119	49	2,75	10	000960500
11	126	52	3,35	10	000960510
12	134	56	4,05	10	000960520
13	142	62	5,40	10	000960530
14	151	69	6,05	10	000960540
16	165	72	9,30	5	000960560
17	174	79	9,95	5	000960570
19	194	88	13,60	5	000960590
22	216	99	24,80	1	000960592
24	242	111	33,00	1	000960594



	€	📦	🚚
96N/ST6 2,5-3-4-5-6-8 mm	9,25	3	000960640



	€	📦	🚚
96N/G7 2,5-3-4-5-6-8-10 mm	22,90	3	000960645
96N/G7A 1,5-2-2,5-3-4-5-6 mm	15,90	3	000960643



	€	📦	🚚
96N/B10 1,5-2-2,5-3-4-5-6-8-10-12 mm	14,90	5	000960650
96N/BV	1,65	1	000960651



96N/SC9 1,5-2-2,5-3-4-5-6-8-10 mm	€ 13,00	1	000960644
96N/SCV	3,85	1	000960986



96N/SC12 2-2,5-3-3,5-4-4,5-5-6-7-8-9-10 mm	€ 18,40	1	000960661
96N/SCV12	4,40	1	000960976

96C/AS

chaves de aperto sextavadas, cromadas



"	L mm	L1 mm	g	€		
1/16	46	16	1,01	1,60	20	000961702
3/32	53	19	2,70	2,20	20	000961706
1/8	60	22	5,33	2,30	20	000961710
5/32	67	25	9,33	2,70	20	000961714
3/16	74	28	14,87	3,10	20	000961716
7/32	81	32	22,00	3,45	20	000961718
1/4	89	35	31,40	3,85	20	000961720
5/16	103	40	56,16	4,30	10	000961724
3/8	117	45	91,31	5,05	10	000961728



96C-AS/SC9 1/16-3/32-1/8-5/32-3/16-7/32-1/4-5/16-3/8	€ 32,50	1	000961753
--	---------	---	-----------



96AS

chaves macho hexagonal, brunidas



"	L mm	L1 mm	€		
1/30 (0,035")	44	14	0,80	20	000960698
1/20 (0,050")	44	15	0,80	20	000960701
1/16	46	16	0,90	20	000960702
5/64	50	18	1,05	20	000960704
3/32	53	19	1,20	20	000960706
7/64	57	21	1,30	20	000960708
1/8	60	22	1,30	20	000960710
9/64	64	24	1,55	20	000960712
5/32	68	25	1,55	20	000960714
3/16	75	29	1,70	20	000960716
7/32	82	32	1,95	20	000960718
1/4	89	35	2,25	20	000960720
5/16	103	40	2,75	10	000960724
3/8	117	44	3,40	10	000960728
7/16	132	49	4,95	10	000960730
1/2	149	54	6,20	10	000960732
9/16	151	69	10,10	2	000960734
5/8	165	72	12,40	1	000960736
3/4	194	88	20,20	1	000960738



96AS/SC9 1/16-3/32-1/8-5/32-3/16-7/32-1/4-5/16-3/8	€ 20,70	1	000960743
96AS/SCV	3,85	1	000960744



96AS/T7 3/32-1/8-5/32-3/16-7/32-1/4-5/16	€ 17,30	3	000960740
--	---------	---	-----------



96AS/G7 3/32-1/8-5/32-3/16-1/4-5/16-3/8	€ 24,00	3	000960745
---	---------	---	-----------



96AS/BG7 3/32-1/8-5/32-3/16-1/4-5/16-3/8	€ 29,50	1	000960747
--	---------	---	-----------



96AS/B11 1/20-1/16-5/64-3/32-1/8-5/32-3/16-7/32-1/4-5/16-3/8	€ 20,30	1	000960749
96N/BV	1,65	1	000960651

96LC

chaves macho hexagonal série longa, cromadas



ISO 2936

mm	L mm	L1 mm	€		
2	101	17	1,65	20	000960320
2,5	113	20	1,75	20	000960321
3	127	22	1,95	20	000960322
3,5	138	25	2,00	20	000960323
4	142	28	2,15	20	000960324
4,5	154	28	2,55	20	000960325
5	163	32	2,75	20	000960326
6	184	37	2,95	20	000960327
7	194	40	3,40	10	000960328
8	205	43	4,15	10	000960329
9	216	46	4,60	10	000960330
10	231	49	5,95	10	000960331
12	259	56	7,50	10	000960332



96LC/SC8 2-2,5-3-4-5-6-8-10 mm	€ 27,00	1	000960334
96LC/SCV	3,85	1	000960983



96LC/SC12 2-2,5-3-3,5-4-4,5-5-6-7-8-9-10 mm	€ 40,00	1	000960337
96LC/SCV12	4,40	1	000960977



96L

chaves macho hexagonal
série longa, brunidas



ISO 2936

mm	L mm	L1 mm	€	🔧	📦
2	99	15	1,20	20	000960820
2,5	110	17	1,25	20	000960825
3	124	19	1,40	20	000960830
3,5	135	21	1,50	20	000960835
4	138	24	1,65	20	000960840
4,5	150	25	1,95	20	000960845
5	158	27	2,05	20	000960850
6	178	31	2,30	20	000960860
7	187	33	2,90	10	000960870
8	197	35	3,70	10	000960880
9	207	37	4,15	10	000960890
10	221	39	5,55	10	000960900
12	247	44	6,90	10	000960920



96L/SC8 2-2,5-3-4-5-6-8-10 mm	€ 22,70	🔧 1	📦 000960924
96L/SCV	3,85	🔧 1	📦 000960987



96L/SC12 2-2,5-3-3,5-4-4,5-5-6-7-8-9-10 mm	€ 34,00	🔧 1	📦 000960929
96L/SCV12	4,40	🔧 1	📦 000960978

96BPC

chaves macho hexagonal
com uma extremidade esférica, cromadas



mm	L mm	L1 mm	€	🔧	📦
1,5	79	13	2,00	10	000960340
2	84	15	2,10	10	000960341
2,5	89	17	2,20	10	000960342
3	99	19	2,35	10	000960343
4	108	24	2,70	10	000960344
5	126	27	3,30	10	000960345
6	148	31	4,70	10	000960346
7	157	33	6,20	5	000960353
8	168	35	6,30	5	000960347
10	187	39	10,20	5	000960348
12	220	55	12,40	5	000960352



96BPC/SC9 1,5-2-2,5-3-4-5-6-8-10 mm	€ 39,50	🔧 1	📦 000960354
96BPC/SCV	3,85	🔧 1	📦 000960984

96BP

chaves macho hexagonal com uma
extremidade esférica, brunidas

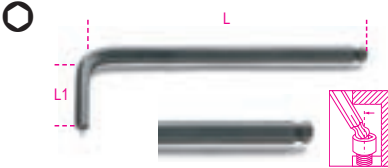

mm	L mm	L1 mm	€	🔧	📦
1,5	79	13	1,50	10	000960960
2	84	15	1,60	10	000960961
2,5	89	17	1,65	10	000960962
3	99	19	1,70	10	000960963
4	108	24	2,00	10	000960965
5	126	27	2,65	10	000960967
6	148	31	3,85	10	000960968
8	168	35	5,35	5	000960970
10	187	39	9,40	5	000960972
12	220	55	13,50	5	000960973



96BP/SC9 1,5-2-2,5-3-4-5-6-8-10 mm	€ 33,50	🔧 1	📦 000960974
96BP/SCV	3,85	🔧 1	📦 000960988

96LBP

chave sextavada ponta de bola, modelo extra
longo



mm	L mm	L1 mm	€	🔧	📦
1,5	90	15	2,25	5	000961340
2	100	17	2,35	5	000961341
2,5	112	20	2,55	5	000961342
3	127	22	2,65	5	000961343
4	144	27	3,30	5	000961344
5	163	32	3,95	5	000961345
6	184	37	5,35	5	000961346
8	204	44	7,35	2	000961348
10	230	49	11,90	2	000961350



96LBP/SC9 1,5-2-2,5-3-4-5-6-8-10 mm	€ 45,50	🔧 1	📦 000961354
96LBP/SCV	3,85	🔧 1	📦 000961984

96BP/AS

chaves macho hexagonal
com uma extremidade esférica, brunidas

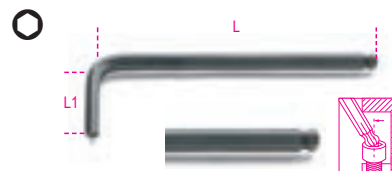

"	L mm	L1 mm	€	🔧	📦
3/32	89	17	1,80	10	000960989
1/8	98	18	1,95	10	000960990
5/32	108	24	2,30	10	000960991
3/16	126	26	2,65	10	000960992
7/32	139	28	3,85	10	000960993
1/4	152	31	4,15	10	000960994
5/16	168	34	5,40	5	000960995
3/8	190	39	9,25	5	000960996



96BP-AS/SC9 1/16-3/32-1/8-5/32-3/16-7/32-1/4-5/16-3/8	€ 36,00	🔧 1	📦 000961000
96BP-AS/SCV	3,85	🔧 1	📦 000961001



96BP-AS/8 3/32-1/8-5/32-3/16-7/32-1/4-5/16-3/8	€ 33,00	🔧 1	📦 000960997
96BP-AS/BV	1,65	🔧 1	📦 000960998



96BPA

chave sextavada ponta de bola, 110°, modelo extra curto



mm	L mm	L1 mm	€	U	PC
1,5	71	9	2,20	5	000961960
2	86	11	2,30	5	000961961
2,5	96	13	2,40	5	000961962
3	104	15	2,65	5	000961963
4	116	17	3,20	5	000961964
5	132	19	3,75	5	000961965
6	155	21	5,35	5	000961966
8	176	24	7,15	2	000961968
10	200	27	11,20	2	000961970



96BPA/SC9	44,00	1	000961974
1,5-2-2,5-3-4-5-6-8-10 mm			
96BPA/SCV	3,85	1	000961988

96T

chaves macho hexagonal com punho



mm	L mm	L1 mm	€	U	PC
2	139	52	10,40	5	000960934
2,5	153	55	10,40	5	000960935
3	153	55	10,70	5	000960936
3,5	179	70	11,20	5	000960937
4	179	70	11,20	5	000960938
4,5	200	84	11,40	5	000960939
5	200	84	11,40	5	000960940
6	221	103	13,00	5	000960941
7	236	106	14,20	3	000960942
8	255	117	16,40	3	000960943
10	285	132	18,60	3	000960945



96T/S6	67,50	1	000960952
2-2,5-3-4-5-6 mm			
96T/S8	102,00	1	000960933
2-2,5-3-4-5-6-8-10 mm			
96T/S11	139,00	1	000960951
2-2,5-3-3,5-4-4,5-5-6-7-8-10 mm			



96T/SP11	151,00	1	000960957
2-2,5-3-3,5-4-4,5-5-6-7-8-10 mm			
96T/SPV	14,80	1	000960958
96T/S11			
97TTX/S11			

96T/AS

chaves macho hexagonal com punho



"	L mm	L1 mm	€	U	PC
3/32	153	55	12,80	2	000960669
7/64	153	55	12,80	2	000960670
1/8	179	70	13,00	2	000960671
9/64	179	70	13,60	2	000960672
5/32	200	84	13,60	2	000960673
3/16	200	84	13,60	2	000960674
7/32	221	103	15,20	2	000960675
1/4	236	106	16,90	2	000960676
5/16	255	117	19,10	2	000960678
3/8	285	132	22,50	2	000960680



96T/AS8	124,00	1	000960682
3/32-7/64-1/8-5/32-3/16-1/4-5/16-3/8			
96T/AS10	153,00	1	000960683
3/32-7/64-1/8-9/64-5/32-3/16-7/32-1/4-5/16-3/8			



96TBP

chaves macho hexagonal com punho e extremidade esférica



mm	L mm	L1 mm	€	U	PC
2,5	153	55	10,70	3	000960685
3	153	55	11,40	3	000960686
4	179	70	11,90	3	000960687
5	200	84	12,50	3	000960688
6	221	103	13,60	3	000960689
8	255	117	18,00	2	000960690
10	285	132	19,20	2	000960692



96TBP/S6	78,00	1	000960694
2,5-3-4-5-6-8 mm			

97TX

chaves macho para parafusos com cabeça Torx®



mm	L mm	L1 mm	€	U	PC
T6	42	16	5,85	5	000970006
T7	48	16	5,85	5	000970007
T8	48	16	5,85	5	000970008
T9	48	16	6,35	5	000970009
T10	51	17	6,50	5	000970010
T15	54	18	6,50	5	000970015
T20	57	19	6,90	5	000970020
T25	60	20	7,10	5	000970025
T27	64	21	7,75	5	000970027
T30	70	24	7,75	5	000970030
T40	76	26	8,65	5	000970040
T45	83	29	10,30	5	000970045
T50	95	32	11,70	5	000970050
T55	108	35	15,10	5	000970055
T60	120	38	20,00	5	000970060



97TX/ST8	63,00	1	000970640
T9-T10-T15-T20-T25-T27-T30-T40			



97TX/G8	€ 49,00	1	000970645
T9-T10-T15-T20-T25			
T27-T30-T40			



97TX/BG8	€ 38,50	1	000970368
T9-T10-T15-T20-T25-T27-T30-T40			



97TX/SC8	€ 61,50	1	000970064
T9-T10-T15-T20-T25			
T27-T30-T40			
97TX/SCV	€ 3,85	1	000970985



97TX/B13	€ 98,50	1	000970650
T6-T7-T8-T9-T10-T15-T20			
T25-T27-T30-T40-T45-T50			
96N/BV	€ 1,65	1	000960651

97BTX

chaves macho com uma extremidade esférica, para parafusos com cabeça Torx®

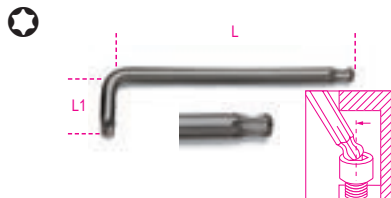

⊕	L mm	L1 mm	€	📦	📄
T9	80	16	7,35	5	000970109
T10	86	17	7,35	5	000970110
T15	90	18	7,35	5	000970115
T20	95	19	7,85	5	000970120
T25	100	20	8,40	5	000970125
T27	105	21	8,85	5	000970127
T30	114	24	8,95	5	000970130
T40	124	26	10,20	5	000970140
T45	133	28	12,10	5	000970145
T50	152	32	13,50	3	000970150
T55	164	35	19,50	3	000970155



97BTX/SC8	€ 70,00	1	000970164
T9-T10-T15-T20-T25-T27-T30-T40			
97BTX/SCV	€ 3,85	1	000970983



97BTX/B8	€ 68,00	1	000970159
T9-T10-T15-T20-T25			
T27-T30-T40			
96N/BV	€ 1,65	1	000960651

97BTXL

chaves macho com uma extremidade esférica, para parafusos com cabeça Torx®, modelo longo



	L mm	L1 mm	€	📦	📄
T9	80	15	7,65	3	000970309
T10	86	17	7,65	3	000970310
T15	100	18	7,65	3	000970315
T20	110	19	8,75	3	000970320
T25	126	20	9,60	3	000970325
T27	140	24	10,70	3	000970327
T30	160	28	11,30	3	000970330
T40	176	32	13,30	3	000970340



97BTXL/SC8	€ 80,50	1	000970364
T9-T10-T15-T20-T25-T27-T30-T40			
97BTXL/SCV	€ 3,85	1	000970982

97RTX

chaves macho para parafusos com cabeça Tamper Resistant Torx®



⊕	L mm	L1 mm	€	📦	📄
T9	56	16	6,85	5	000970209
T10	62	17	7,00	5	000970210
T15	72	17	7,00	5	000970215
T20	83	18	7,20	5	000970220
T25	90	18	7,45	5	000970225
T27	100	20	8,35	5	000970227
T30	105	24	8,40	5	000970230
T40	112	26	9,30	5	000970240



97RTX/SC8	€ 65,50	1	000970263
T9-T10-T15-T20-T25			
T27-T30-T40			
97RTX/SCV	€ 3,85	1	000970984



97RTX/B8	€ 63,50	1	000970260
T9-T10-T15-T20-T25			
T27-T30-T40			
96N/BV	€ 1,65	1	000960651

97TTX

chaves duplas macho com punho para parafusos com cabeça Torx®

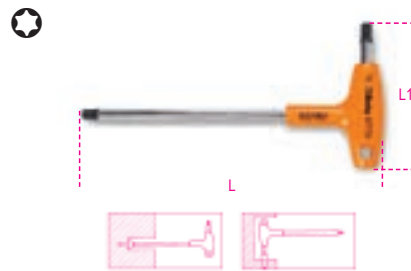

⊕	L mm	L1 mm	€	📦	📄
T6	130	52	10,50	3	000970706
T7	130	52	10,50	3	000970707
T8	139	52	10,50	3	000970708
T9	139	52	10,50	3	000970709
T10	179	70	10,90	3	000970710
T15	179	70	11,80	3	000970715
T20	179	70	12,30	3	000970720
T25	179	70	12,90	3	000970725
T27	200	84	14,20	3	000970727
T30	200	84	14,80	3	000970730
T40	221	103	17,50	3	000970740
T45	236	106	20,30	2	000970745
T50	255	117	26,00	2	000970750



97TTX/S6	€ 80,50	1	000970791
T10-T15-T20-T25-T30-T40			
97TTX/S8	€ 105,00	1	000970808
T8-T10-T15-T20-T25-T27-T30-T40			
97TTX/S11	€ 162,00	1	000970800
T8-T9-T10-T15-T20-T25-T27-T30-T40-T45-T50			
97TTX/S13	€ 183,00	1	000970813
T6-T7-T8-T9-T10-T15-T20-T25-T27-T30-T40-T45-T50			



97TTX/SP11	€ 174,00	1	000970840
T8-T9-T10-T15-T20-T25			
T27-T30-T40-T45-T50			
96T/SPV	€ 14,80	1	000960958
96T/S11			
97TTX/S11			

98XZN

chaves macho hexagonal com perfil XZN®

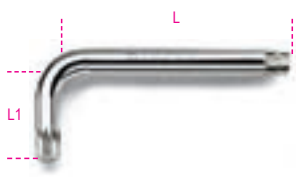

DIN 65253

Ø	L mm	L1 mm	€	U	IT
M5	83	25	5,05	5	000980005
M6	89	30	5,80	5	000980006
M8	97	32	7,35	5	000980008
M10	106	35	9,60	5	000980010
M12	116	37	12,10	5	000980012
M14	118	45	15,40	5	000980014
M16	125	45	22,90	5	000980016



98XZN/B5	€ 41,50	1	000980650
M5-M6-M8-M10-M12			
96N/BV	€ 1,65	1	000960651

99

chaves de unha quadrada para porcas com encaixes laterais UNI/ISO 2982, 2983



UNI 6752

Ø mm	A mm	€	U	IT
12-14	1,5	9,50	3	000990012
16-18-20	1,8	9,50	3	000990016
22-25-28	1,8	12,60	3	000990022
30-32	2,1	12,60	3	000990030
34-36-38	2,4	15,40	3	000990034
40-42	2,4	15,40	3	000990040
45-50	2,5	19,00	3	000990045
52-55-58	2,5	19,00	3	000990052
62-65	3,1	24,00	3	000990062
68-70-75	3,1	24,00	3	000990068
80-85-90	3,8	32,00	2	000990080
92-95	4,3	32,00	2	000990092
98-100	4,3	32,00	2	000990098
105-110-115	4,4	51,50	1	000990105
120-125-130	4,9	51,50	1	000990120
135-145	6,0	76,50	1	000990135
155-165	6,0	76,50	1	000990155

99SQ

chaves de unha quadrada articulada para porcas com encaixes laterais



Ø mm	B mm	€	U	IT
15-35	2,7	26,00	2	000990215
35-50	3,5	29,50	2	000990235
50-80	4,7	38,50	2	000990250
80-120	6,2	52,50	2	000990280
120-180	7,8	70,00	2	000990290

99ST

chaves de unha articulada com pino redondo amovível



Ø mm	Ø mm	B mm	€	U	IT
15-35	3,0	2,5	26,50	2	000990315
35-50	4,0	4,5	32,00	2	000990335
50-80	5,0	5,0	41,50	2	000990350
80-120	6,0	7,0	56,50	2	000990380
120-180	8,0	9,0	73,50	2	000990390

99 VN/...

ponta de substituição para artigo 99ST

Ø mm	mm	€	U	IT
99ST VN/15	15-35	7,35	1	000990295
99ST VN/35	35-50	8,40	1	000990296
99ST VN/50	50-80	10,20	1	000990297
99ST VN/80	80-120	11,80	1	000990298
99ST VN/120	120-180	15,20	1	000990299

100

chaves de compasso com unhas redondas para porcas com furos de manobra frontais



Ø mm	L mm	Ø min-max mm	€	U	IT
4,9-5,9	250	18÷100	135,00	1	001000001
6,9-7,9					

100/KIT

unhas de substituição para refª. 100



100/KIT	€ 43,00	1	001000010
----------------	---------	---	-----------

111

chaves ajustáveis com escala, cromadas

- Rotação direita do pino
- Com escala em mm e polegadas



DIN 3117 ISO 6787

L mm	L"	A max mm	€	U	IT
100	4	15	21,30	3	001110010
150	6	24	22,40	3	001110015
200	8	28	27,00	3	001110020
250	10	34	33,50	3	001110025
300	12	35	44,00	3	001110030
380	15	45	86,50	3	001110038
450	18	54	143,00	2	001110045
600	24	62	196,00	1	001110060

111N

chaves ajustáveis com escala, fosfatadas

- Rotação direita do pino
- Com escala em mm e polegadas



DIN 3117 ISO 6787

L mm	L"	A max mm	€	U	IT
100	4	15	19,70	3	001110210
150	6	24	20,80	3	001110215
200	8	28	24,00	3	001110220
250	10	34	30,00	3	001110225
300	12	35	41,00	3	001110230
380	15	45	78,50	3	001110238
450	18	54	135,00	2	001110245

111G

chaves ajustáveis com escalas cromadas, punhos de 2 componentes

- Rotação do pino à direita
- Escala em mm e polegadas
- Punho ergonómico



DIN 3117 ISO 6787

L mm	L"	A max mm	€	U	IT
200	8	28	32,50	3	001110620
250	10	34	40,00	3	001110625
300	12	35	51,50	2	001110630



120

chaves de luneta aberta de 12 faces com sistema de roquete simples



mm	L mm	€		
10	135	44,00	1	001200010
11	135	44,00	1	001200011
12	135	44,00	1	001200012
13	135	44,00	1	001200013
14	135	50,00	1	001200014
17	185	52,00	1	001200017
19	185	55,50	1	001200019
22	230	77,00	1	001200022
24	230	82,50	1	001200024
27	230	105,50	1	001200027
30	320	120,00	1	001200030
32	320	126,00	1	001200032



	€		
120/B6 10-11-13 17-19-22 mm	323,00	1	001200050
120/BV	8,75	1	001200051

123E1/4

adaptador, 1/4", para chaves de roquete de 10 mm

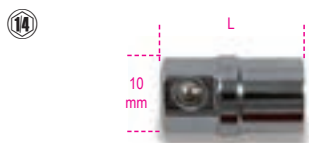

mm	L mm	€		
10	20,6	5,80	1	001230010

123Q1/4

adaptador de desengate rápido, 1/4", para chaves de roquete, 10mm

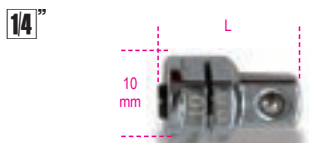

mm	L mm	€		
10	17,5	7,85	1	001230310

123Q3/8

adaptador de desengate rápido, 3/8", para chaves de roquete, 13mm



mm	L mm	€		
13	22,5	7,85	1	001230313

123Q1/2

adaptador de desengate rápido, 1/2", para chaves de roquete, 19mm

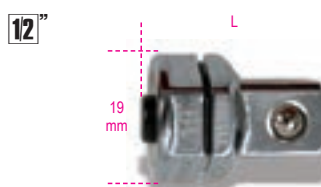

mm	L mm	€		
19	30,5	8,55	1	001230319

123/K4

kit com 4 adaptadores para chaves de roquete:

- 1 ponta adaptadora
- 3 adaptadores de desengate rápido



	€		
123/K4	30,00	1	001230504

142

chaves boca/luneta com sistema de roquete



mm	L mm	€		
6x6	136	15,70	3	001420006
7x7	136	15,70	3	001420007
8x8	136	16,30	3	001420008
9x9	143	17,30	3	001420009
10x10	159	17,90	3	001420010
11x11	168	18,40	3	001420011
12x12	174	18,90	3	001420012
13x13	180	20,40	3	001420013
14x14	190	21,10	2	001420014
15x15	200	22,40	2	001420015
16x16	216	24,00	2	001420016
17x17	233	24,60	2	001420017
18x18	239	26,50	2	001420018
19x19	248	27,00	2	001420019
21x21	285	35,50	1	001420021
22x22	285	37,00	1	001420022
24x24	325	43,00	1	001420024
27x27	355	62,00	1	001420027
30x30	420	72,50	1	001420030
32x32	420	75,00	1	001420032
* 36x36	480	104,50	1	001420036



	€		
142/B6 8-10-13-14-17-19 mm	136,00	1	001420066
142/BV6	8,20	1	001420076
142/B9 8-10-11-12-13-14-15-17-19 mm	197,00	1	001420069
142/BV9	9,85	1	001420079



	€		
142/S15 6-7-8-9-10-11-12-13 14-15-16-17-18-19-22 mm	322,00	1	001420074
142/S17 6-7-8-10-11-12-13-14-15- 16-17-18-19-21-22-24-27 mm	444,00	1	001420068
142/S19 6-7-8-9-10-11-12 13-14-15-16-17-18 19-22-24-27-30-32 mm	574,00	1	001420075

142/SC9I-E

jogo de 9 chaves mistas boca luneta, com sistema de roquete, suporte compacto



	€		
142/SC9I 8-10-11-12-13-14-15-17-19 mm	195,00	1	001420087
142/SCV9I	9,30	1	001420103
142/SC9E 8-10-11-12-13-16-17-18-19 mm	202,00	1	001420088
142/SCV9E	9,30	1	001420104

142AS

chaves boca/luneta com sistema de roquete



	L mm	€		
5/16x5/16	136	19,10	2	001420308
3/8x3/8	159	19,70	2	001420310
7/16x7/16	168	20,80	2	001420311
1/2x1/2	180	23,20	2	001420313
9/16x9/16	190	23,70	2	001420314
5/8x5/8	216	26,00	2	001420316
11/16x11/16	233	26,50	2	001420317
3/4x3/4	248	29,50	2	001420319



142AS /8	€ 188,00	1	001420330
5/16-3/8-7/16-1/2			
9/16-5/8-11/16-3/4			

142C

chaves boca/luneta, série curta



mm	L mm	€		
8x8	88	11,60	2	001420108
9x9	96	11,60	2	001420109
10x10	96	12,00	2	001420110
11x11	100	12,80	2	001420111
12x12	104	13,70	2	001420112
13x13	108	14,40	2	001420113
14x14	114	15,10	2	001420114
15x15	118	15,60	2	001420115
16x16	122	16,20	2	001420116
17x17	128	17,50	2	001420117
18x18	132	18,70	2	001420118
19x19	138	19,10	2	001420119



142C/A12	€ 202,00	1	001420175
8-9-10-11-12-13-14			
15-16-17-18-19 mm			

142SN

chaves boca/luneta articulada com sistema de roquete



mm	L mm	€		
7x7	136	18,80	2	001420207
8x8	136	19,70	2	001420208
9x9	143	20,20	2	001420209
10x10	160	21,80	2	001420210
11x11	168	22,40	2	001420211
12x12	174	22,90	2	001420212
13x13	180	24,60	2	001420213
14x14	193	25,50	2	001420214
15x15	200	27,00	2	001420215
16x16	216	29,00	2	001420216
17x17	233	29,50	2	001420217
18x18	239	32,00	2	001420218
19x19	250	32,50	2	001420219
22x22	285	37,50	1	001420222
24x24	325	42,00	1	001420224



142SN/S13	€ 324,00	1	001420263
7-8-9-10-11-12-13-14			
15-16-17-18-19 mm			

186

chave auto-ajustável, 8 a 32 mm

Ideal para parafusos de cabeça sextavada, quadrada, Spline e Torx®, mesmo danificados.



L mm	€		
260	45,00	1	001860008

187

chave de luneta articulada



mm	L mm	€		
8x9	125	29,50	1	001870008
10x11	155	32,00	1	001870010
12x13	175	33,00	1	001870012
14x15	205	36,00	1	001870014
16x17	235	41,00	1	001870016



187/B5	€ 181,00	1	001870050
8x9-10x11-12x13			
14x15-16x17 mm			

188

chaves de luneta plana bi-sextavadas com roquete para polias livres de alternador



mm	L mm	€		
10	240	20,40	2	001880010
15	322	27,00	2	001880015

192

chaves bi-hexagonais com sistema de roquete reversível, cromadas, 4 in 1



mm	L mm	€		
8x10/12x13	160	26,00	1	001920008
16x17/18x19	230	33,50	1	001920016



192/S2	€ 59,50	1	001920070
8x10/12x13 mm			
16x17/18x19 mm			

194

chave de caixa com sistema de roquete reversível



mm	L mm	€		
1/4x5/16	128	34,00	2	001940006

195

chave de luneta dupla, bi-hexagonal, com sistema de roquete



mm	L mm	€		
8x10	128	18,10	2	001950010
12x13	170	21,00	2	001950013
14x15	190	22,10	2	001950015
16x18	230	25,50	2	001950018
17x19	230	26,00	2	001950019



195/B5	€ 123,00	1	001950066
8x10-12x13-14x15			
16x18-17x19 mm			
195/BV5	€ 9,85	1	001950070

195AS

chave de luneta dupla cromada, bisextavada, com sistema de roquete



mm	L mm	€		
5/16x3/8	128	18,70	2	001950606
7/16x1/2	170	21,00	2	001950611
9/16x5/8	190	23,70	2	001950614
11/16x3/4	230	26,00	2	001950617



195AS/B4	€ 99,50	1	001950654
5/16x3/8 - 7/16x1/2 - 9/16x5/8 - 11/16x3/4			
195FTX/BV4	€ 9,85	1	001950520

195P

chave bi-hexagonal dupla inclinada a 15° e com sistema de roquete reversível



Ø mm	L mm	€		
8x10	128	27,50	2	001950210
12x13	170	29,50	2	001950213
14x15	190	31,00	2	001950215
16x18	230	34,00	2	001950218
17x19	230	36,00	2	001950219



195P/B5	€ 167,00	1	001950266
8x10-12x13-14x15 16x18-17x19 mm			
195/BV5	€ 9,85	1	001950070

310

ferro de soldar tubos e uniões de pequenas dimensões em plástico tipo PE, PP, PVC e PEHD

CE



230V-650 Watt
50 Hz±60Hz
Schuko (CEE 7/7)

	Ø mm	€		
310/1	16÷50	238,00	1	003100001
310/2	16÷63	331,00	1	003100002

310B

matrizes para o polifusor modelo 310



Ø mm	€		
16	57,50	1	003100016
20	63,00	1	003100020
25	66,50	1	003100025
32	73,50	1	003100032
40	86,50	1	003100040
50	109,00	1	003100050
63	126,00	1	003100063

310/C4

jogo com polifusor e 3 matrizes



310/C4	€ 479,00	1	003100104
310/1+310B: Ø 20-25-32			
410x260x82 mm - 4,8 kg			

310/C8

jogo com polifusor e 7 matrizes



310/C8	€ 743,00	1	003100108
310/2+310B: Ø 16-20-25 32-40-50-63			
440x270x120 mm - 7,7 kg			

311

ferro de soldar tubos e uniões de grandes dimensões em plástico tipo PE, PP, PVC e PEHD

CE

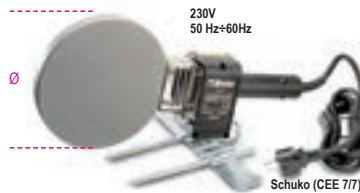

230V
50 Hz±60Hz
Schuko (CEE 7/7)

	Ø mm	Watt	€		
311/1	120	300	289,00	1	003110001
311/2	190	900	329,00	1	003110002

330

corta-tubos para tubos de gás em aço



	Ø mm - "	L mm	€		
330/2	10÷60	380	139,00	1	003300002
330/4	1/8"÷2" 60÷115 2"÷4"	585	314,00	1	003300004

330R/A

cortante de substituição para o modelo 330 para tubos em aço

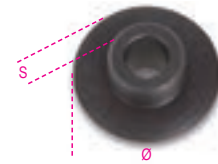

	Ø mm	S mm	€		
330R/A2	32	7	13,10	1	003300012
330R/A4	42	9	34,50	1	003300014

330R/I

cortante de substituição para o artigo 330 para tubos de aço inox



	Ø mm	S mm	€		
330R/I2	32	7	30,00	1	003300024
330R/I4	32	9	82,50	1	003300034

331L

corta-tubos com roquete para cobre e ligas leves



	Ø mm - "	L mm	€		
8÷29		180	63,00	1	003310008
5/16"÷1"1/8					

331LR/L

lâmina de substituição para corta-tubos 331L



	Ø mm	€		
331LR/L	18	6,00	1	003310058

332

mini corta-tubos para cobre e ligas leves



	Ø mm - "	L mm	€		
3÷16		59	19,70	2	003320001
1/8"÷5/8"					

334

corta-tubos para cobre e ligas leves



Ø mm - "	L mm	€	1	003340001
3÷30 1/8"÷1"1/8	150	27,00	1	003340001

334R

cortante de substituição para os modelos com refª. 332 e 334 para cobre e ligas leves

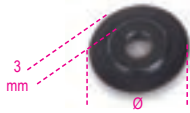

Ø mm	€	1	003340021
334R 18	5,45	1	003340021

334R/I

cortante de substituição para os modelos com refª. 332 e 334 para aço inox

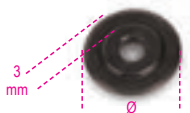

Ø mm	€	1	003340023
334R/I 18	16,20	1	003340023

336

corta-tubos com avanço telescópico para cobre e ligas leves



Ø mm - "	L mm	€	1	003360001
6÷38 1/4"÷1"1/2	160	46,00	1	003360001

338

corta-tubos com avanço telescópico rápido para cobre, ligas leves e plásticos



Ø mm - "	L mm	€	1	003380001
6÷67 1/4"÷2"5/8	290	114,00	1	003380001

338R

cortante de substituição para os modelos 336 e 338 para cobre e ligas leves



Ø mm	€	1	003380022
338R 18,5	6,00	1	003380022

338R/I

cortante de substituição para os modelos 336 e 338 para aço inox



Ø mm	€	1	003380023
338R/I 21,8	18,10	1	003380023

338RP

cortante de substituição para os modelos 336 e 338 para plástico



Ø mm	€	1	003380025
338RP 21,9	6,55	1	003380025

339A

corta-tubos com avanço telescópico rápido para tubos de plástico



Ø mm - "	L mm	€	1	003390011
50÷127 2"÷5"	345	241,00	1	003390011

339A/R

cortante de substituição para o modelo 339A



Ø mm	€	1	003390061
339A/R 42	16,40	1	003390061

340

alicate para corte de tubos multi-camadas max. Ø 26 mm

- Lâmina com revestimento PTFE
- 4 rolos de suporte para facilitar a rotação do tubo durante o trabalho
- Punho com sistema integrado para corte de tubos ondulados
- Corpo leve em magnésio
- Ø máx.: 26 mm



Ø max mm	€	1	003400001
340 26	94,00	1	003400001

340RL

Lamina de substituição para o item 340



€	1	003400010
340RL 26,00	1	003400010

341

alicate corta-tubos para tubos plásticos



Ø mm	L mm	€	1	003410001
0÷25	190	33,00	1	003410001

341RL

lâmina de substituição para o modelo 341



€	1	003410010
341RL 13,80	1	003410010

Beta

341B

tesoura com roquete para tubos de plástico



Ø	L	€		
mm - "	mm			
0÷35	195	62,00	1	003410051

341B/RM

mola de substituição para o artigo 341B

341B/RM	€			
	2,30	1	003410061	

341B/RL

lâminas de substituição para o artigo 341B



341B/RL	€			
	21,80	1	003410060	

342

Tesoura com roquete para tubos de plástico



Ø	L	€		
mm - "	mm			
0÷42	200	45,50	1	003420030
1"5/8				

342MOL

mola de substituição para o artigo 342

342MOL	€			
	3,30	1	003420033	

342RL

lâmina de substituição para o artigo 342



342RL	€			
	20,20	1	003420032	

342A

tesoura com roquete para tubos plásticos



Ø	L	€		
mm - "	mm			
0÷50	270	90,50	1	003420101
2"				

342A/MOL

mola de substituição para artigo 342A

342A/MOL	€			
	2,00	1	003420111	

342A/RL

lâmina de substituição para o modelo 342A



342A/RL	€			
	47,50	1	003420110	

342P

tesoura com roquete para tubos plásticos, corpo em liga de magnésio



Ø	L	€		
mm - "	mm			
0÷50	260	100,50	1	003420121
2"				

342P/RL

lâmina de substituição para ref. 342P



342P/RL	€			
	41,50	1	003420130	

345

ferramenta rebarba-tubos corpo em metal

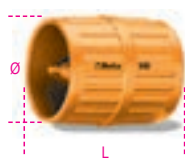

Ø	L	€		
mm - "	mm			
3÷42	58	25,50	5	003450001
1/8"÷1"5/8				

345U

ferramenta rebarba-tubos para aço inoxidável, aço, cobre e ligas leves



Ø	L	€		
mm - "	mm			
4÷36	60	65,50	1	003450050
5/32÷1"7/16				

345C

manómetro para tubos com várias camadas



Ø	€			
mm				
16-20-26-32	40,00	1	003450032	

345SB

rebarbador de lâmina giratório com lâmina intermutável



L	€			
mm				
150	20,40	5	003450010	

345SB/R

lâmina de substituição para o modelo 345SB



345SB/R	€			
	7,10	3	003450015	

349

abocardador com embraiagem para tubos em cobre e ligas leves



3/8"	€			
mm - "				
6-8-10-12-14-15-16-18	242,00	1	003490001	
(1/8-3/16-1/4-5/16				
3/8-1/2-5/8-3/4)				
270x200x50 mm - 2,7 kg				

349/SMM

fixador de tubos métrico para artigo 349



∅ mm	€	U	Artigo
6-8-10-12-14-15-16-18	72,50	1	003490011

349/SMAS

fixador de tubos em polegadas para artigo 349



∅ "	€	U	Artigo
1/8-3/16-1/4-5/16 3/8-1/2-5/8-3/4	68,50	1	003490012

350

abocardador, para tubos em cobre e ligas leves



∅ mm	L mm	A mm	€	U	Artigo
4-4,75-6-8 10-12-14	175	104	72,50	1	003500001

351C

corta-tubos e abocardador



351C	€	U	Artigo
	130,00	1	003510010

334	∅ 3÷30 mm (1/8"÷1"1/8)
350	∅ 4÷14 mm
351P	∅ 4-4,75-6-8-10-12-14 mm

225x150x45 mm - 1,6 kg

351P

punções para abocardador refª. 350



	∅ mm	€	U	Artigo
351P 4	4	5,90	3	003510101
351P 4,75	4,75	5,90	3	003510102
351P 6	6	5,90	3	003510103
351P 8	8	5,90	3	003510104
351P 10	10	5,90	3	003510105
351P 12	12	5,90	3	003510106
351P 14	14	5,90	3	003510107

352U

abocardador regulável para cobre e ligas leves

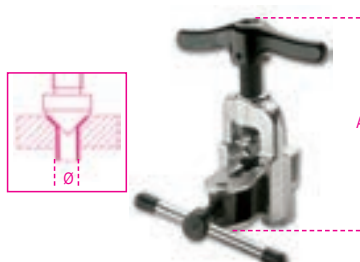

∅ mm - "	A mm	€	U	Artigo
5÷16 3/16÷5/8	130	84,50	1	003520101

352C/U

jogo corta-tubos, rebarbador e abocardador, artigos 334, 345SB e 352U



352C/U	€	U	Artigo
	163,00	1	003520110

334 ∅ 3÷30 mm (1/8"÷1"1/8)

345SB

352U ∅ 5÷16 mm (3/16"÷5/8")

335x145x60 mm - 2120 g

353N

alicate alargador com matriz de expansão intermutável



L mm	€	U	Artigo
380	327,00	1	003530201

353NM

matrizes de expansão para alicate alargador modelo 353N

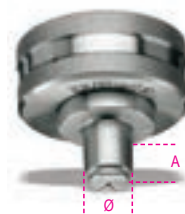

∅ mm	A mm	€	U	Artigo
10	7	111,00	1	003530210
12	10	111,00	1	003530212
14	10	111,00	1	003530214
16	12	111,00	1	003530216
18	12	111,00	1	003530218
22	13	111,00	1	003530222

353N/C6

alicate alargador modelo 353N com matrizes de expansão modelo 353NM



353N/C6	€	U	Artigo
	1.025,00	1	003530300

353N

353NM ∅ 10-12-14-16-18-22 mm

420x185x60 mm - 2,2 kg

355

chave de 5 graduações para radiadores



∅ "	L mm	€	U	Artigo
3/8" - 1/2" 3/4" - 1"	90	34,50	2	003550001

357F3

nível com 3 bolhas



∅ "	L mm	€	U	Artigo
3/8" / 1/2"	90÷220	108,00	1	003570100

357R/F3

bolha de substituição para nível 357F3



357R/F3	€	16,90	1	003570101
---------	---	-------	---	-----------

358

aparelhos para chanfrar externamente tubos plásticos



358/1	Ø mm	16÷110	€	150,00	1	003580001
358/2	Ø mm	40÷250	€	150,00	1	003580002

358RL

lâmina de substituição com batente para os modelos 358/1 e 358/2



358RL	€	27,50	1	003580011
-------	---	-------	---	-----------

359

chave universal para bujões



Ø"	L mm	A mm	€	1	003590001
1"÷1"1/4	160	140	73,50	1	003590001

359CH

adaptador para bujões em cruz para o modelo 359



Ø"	L mm	€	1	003590005
1"1/2	74	41,50	1	003590005

360

chaves para tubos modelo Stillson



L mm	Ø max"	Ø max mm	€	1	003600025
250	1"	34	32,50	1	003600025
350	1"1/2	49	43,00	1	003600035
450	2"	60	59,00	1	003600045
600	2"1/2	76	89,50	1	003600060
900	3"1/2	102	250,00	1	003600090

360R/...

kit peças de substituição para ref. 360 com mordente móvel e porca.

360R250	€	12,00	1	003600225
360R350	€	15,90	1	003600235
360R450	€	23,50	1	003600245
360R600	€	35,50	1	003600260
360R900	€	61,50	1	003600290

362

chaves para tubos modelo americano



L mm	Ø max"	Ø max mm	€	1	003620020
200	1"	34	28,00	1	003620020
250	1"1/2	49	35,00	1	003620025
300	2"	60	41,50	1	003620030
350	2"	60	50,50	1	003620035
450	2"1/2	76	72,50	1	003620045
600	3"	90	110,00	1	003620060
900	5"	140	136,00	1	003620090

362R/...

kit peças de substituição para ref. 362 com: mordente fixa, mordente móvel; porca; pino de segurança.

362R 200	€	5,70	1	003620220
362R 250	€	8,30	1	003620225
362R 300	€	9,85	1	003620230
362R 350	€	11,50	1	003620235
362R 450	€	15,50	1	003620245
362R 600	€	21,30	1	003620260
362R 900	€	53,00	1	003620290

363

chaves para tubos modelo americano em ligas leves



L mm	Ø max"	Ø max mm	€	1	003630035
350	2"	60	61,50	1	003630035
450	2"1/2	76	81,50	1	003630045
600	3"	90	138,00	1	003630060
900	5"	140	259,00	1	003630090
1200	6"	165	271,00	1	003630120

363R/...

kit peças de substituição para ref. 363 com: mordente fixa, mordente móvel; porca; pino de segurança.

363R 350	€	12,70	1	003630235
363R 450	€	17,10	1	003630245
363R 600	€	22,90	1	003630260
363R 900	€	49,00	1	003630290
363R 1200	€	73,50	1	003630320

365

chaves para tubos modelo frontal em ligas leves



L mm	Ø max"	Ø max mm	€	1	003650035
350	2"	60	76,50	1	003650035
450	2"1/2	76	105,00	1	003650045

365R/...

kit peças de substituição para ref. 365 com: mordente fixa, mordente móvel; porca; pino de segurança.

365R 350	€	57,50	1	003650235
365R 450	€	85,50	1	003650245

366

chaves para tubos modelo ligeiro



L mm	Ø max"	Ø max mm	€	1	003660017
175	1"	34	28,00	1	003660017
225	1"1/2	49	34,00	1	003660022
275	2"	60	40,00	1	003660027
300	2"1/2	76	44,00	1	003660030
350	3"	90	50,00	1	003660035

374

chaves para tubos modelo Sueco mordentes a 45°



DIN 5234

L mm	Ø max * gas	Ø max mm	€	🔧	📄
240	1/2" gas	21	34,00	1	003740024
320	1" gas	34	44,50	1	003740032
410	1 1/2" gas	49	58,50	1	003740041
550	2" gas	60	92,50	1	003740055
630	3" gas	90	164,00	1	003740063

375

chave para tubos modelo Sueco com mordentes a 45°



DIN 5234

L mm	Ø max * gas	Ø max mm	€	🔧	📄
320	1" gas	34	45,00	1	003750032
410	1 1/2" gas	49	58,50	1	003750041
550	2" gas	60	92,50	1	003750055

376

chaves para tubos modelo Sueco mordentes planos a 90°



DIN 5234

L mm	Ø max * gas	Ø max mm	€	🔧	📄
320	1" gas	34	45,00	1	003760032
410	1 1/2" gas	49	58,50	1	003760041
550	2" gas	60	92,50	1	003760055
630	3" gas	90	166,00	1	003760063

378

chaves para tubos modelo Sueco mordentes a 45°



DIN 5234

L mm	Ø max * gas	Ø max mm	€	🔧	📄
250	1/2" gas	21	35,50	1	003780025
320	1" gas	34	47,00	1	003780032
410	1 1/2" gas	49	61,50	1	003780041
550	2" gas	60	99,50	1	003780055
650	3" gas	90	169,00	1	003780065

374R/...

kit completo peças de substituição para refs. 374 - 375 - 376 - 378 com porca e batente

Ref.	€	🔧	📄
374R 240 x 374/240-378/250	2,00	1	003740724
374R 320 x 374/320-376/320-378/320	2,20	1	003740732
374R 410 x 374/410-375/410-376/410-378/410	2,40	1	003740741
374R 550 x 374/550-376/550-378/550	3,30	1	003740755
374R 630 x 374/630-378/650	4,60	1	003740763

383

chaves para tubos de correia



Ref.	Ø max * gas	Ø max mm	L mm	€	🔧	📄
383/1	3" gas	90	300	48,00	1	003830001
383/2	8" gas	220	300	50,50	1	003830002

383R

correia de substituição para o modelo 383



Ref.	S mm	€	🔧	📄
383R/1	27	18,80	1	003830010
383R/2	27	20,80	1	003830015

384

chave de corrente para tubos reversível



Ref.	Ø max * gas	Ø max mm	L mm	€	🔧	📄
384	4" gas	115	300	64,00	1	003840032

384RC

corrente de substituição para o modelo 384



Ref.	€	🔧	📄
384RC	40,00	1	003840033

386A

chaves de corrente reversíveis, para trabalhos pesados



Ref.	Ø max gas	L mm	€	🔧	📄
386A/3	4" gas 115 mm	900	213,00	1	003860003
386A/4	6" gas 168 mm	900	409,00	1	003860004
386A/5	8" gas 220 mm	1100	517,00	1	003860005
386A/6	12" gas 324 mm	1300	896,00	1	003860006

386A/RC

correntes de substituição para o modelo 386A



Ref.	€	🔧	📄
386A3/RC	68,50	1	003860013
386A4/RC	98,00	1	003860014
386A5/RC	130,00	1	003860015
386A6/RC	226,00	1	003860016

388

curva tubos para tubos de baixa espessura em cobre, ligas leves ou aço macio

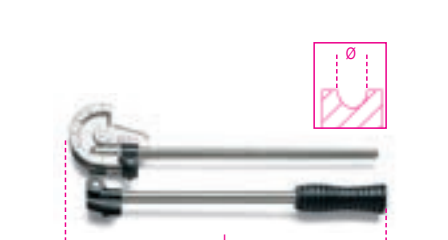

Ø mm	L mm	€	🔧	📄
6	305	52,50	1	003880006
8	315	57,00	1	003880008
10	350	65,50	1	003880010
12	360	70,00	1	003880012
14	455	90,50	1	003880014
15	465	96,00	1	003880015
16	465	104,00	1	003880016

388A

alicate curva-tubos para tubos de baixa espessura em cobre e ligas leves



Ref.	Ø mm	L mm	€	🔧	📄
388A/1	6-8-10 mm	220	57,50	1	003880051
388A/2	1/4"-5/16"-3/8"	220	57,50	1	003880055

388C/C8

curvadora de tubos com 7 matrizes, para tubos finos de cobre e liga leve



388C/C8	∅ mm	€	1	003880200
	10-12-14-16-18-20-22	418,00		

400x330x110 mm - 3,6 kg

392C

alicate ajustável para sifões



392C	∅ mm	L mm	€	1	003920100
	25÷65	260	40,00		

392RG/C

par de protectores de substituição para ref. 392C



392RG/C	€	1	003920101
	5,45		

393

alicate para porcas de torneira



393	L mm	€	1	003930001
	270	58,00		

395

chave articulada para porcas de lavatórios

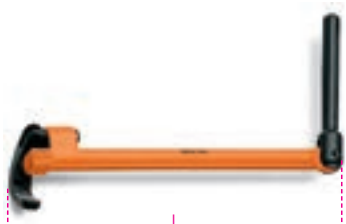

395	∅ mm	L mm	€	1	003950001
	15÷32 mm	240	38,00		

5/8"±1"1/4

395T

chave articulada telescópica para porcas de lavatórios



395T	∅ mm	L mm	€	1	003950100
	10÷32 mm	250÷430	51,50		

399

torno de bancada

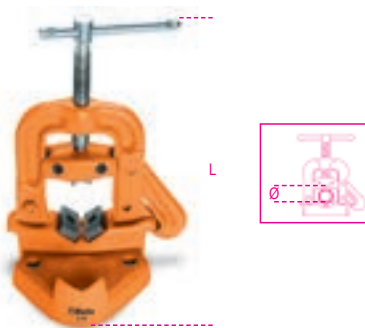

399	∅ mm	L min mm	€	1	003990005
	10÷60 mm	220	159,00		
	1/8÷2"				
	10÷89 mm	290	286,00		
	1/8÷3"				

410

brocas cilíndricas série curta HSS

R ≤ 650 N/mm²
HV ~ 750÷820



DIN 338 ISO 235

410	∅ mm	L mm	L1 mm	€	10	004100030
	0,50	22	6	1,45		
	1,00	34	12	0,80		
	1,25	38	16	0,70		
	1,50	40	18	0,60		
	1,75	46	22	0,60		
	2,00	49	24	0,55		
	2,25	53	27	0,70		
	2,50	57	30	0,60		
	2,75	61	33	0,70		
	3,00	61	33	0,60		
	3,20	65	36	0,80		
	3,25	65	36	0,80		
	3,50	70	39	0,80		
	3,75	70	39	0,90		
	4,00	75	43	0,85		
	4,20	75	43	1,05		
	4,25	75	43	1,05		
	4,50	80	47	0,95		
	4,75	80	47	1,10		
	5,00	86	52	1,00		
	5,25	86	52	1,50		
	5,50	93	57	1,40		
	5,75	93	57	1,55		
	6,00	93	57	1,40		
	6,25	101	63	1,80		
	6,50	101	63	1,70		
	6,75	109	69	2,15		
	7,00	109	69	2,00		
	7,50	109	69	2,10		

∅ mm	L mm	L1 mm	€	10	004100124
8,00	117	75	2,40		
8,50	117	75	2,55		
9,00	125	81	3,20		
9,50	125	81	3,40		
10,00	133	87	3,70		
10,50	133	87	4,55		
11,00	142	94	5,25		
11,50	142	94	5,55		
12,00	151	101	6,25		
12,50	151	101	6,60		
13,00	151	101	7,00		
14,00	160	108	9,35		
15,00	169	114	10,90		
16,00	178	120	13,60		
17,00	186	125	14,90		
18,00	194	130	18,00		
19,00	202	135	20,20		
20,00	210	140	23,80		



410/SP19	∅	€	1	004100419
	1÷10 x 0,5 mm	40,00		
410/SPV1	∅	€	1	004100420
	1÷13 x 0,5 mm	21,30		
410/SP25	∅	€	1	004100425
	1÷13 x 0,5 mm	83,50		
410/SPV2	∅	€	1	004100426
	1÷13 x 0,5 mm	31,00		



410/SEL19	∅	€	1	004100418
	1÷10 x 0,5 mm	31,00		

410MIX/SEL19

jogo de 13 brocas 410 e 6 com inserção de metal duro



410MIX/SEL19	€	1	004100417
	31,50		

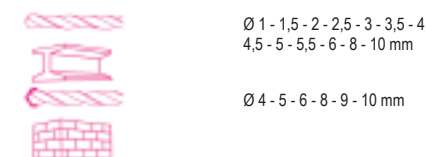

Ø mm	L mm	L1 mm	€		
14,00	160	108	66,50	3	004150164
15,00	169	114	79,50	3	004150168
16,00	178	120	97,50	3	004150172
17,00	186	125	111,00	1	004150174
18,00	194	130	123,00	1	004150176
19,00	202	135	141,00	1	004150178
20,00	210	140	159,00	1	004150180



	€		
415/SP19 Ø 1÷10 x 0,5 mm	163,00	1	004150419
415/SPV1	21,30	1	004150420
415/SP25 Ø 1÷13 x 0,5 mm	338,00	1	004150425
415/SPV2	31,00	1	004150426
415/SP49	842,00	1	004150431
415/SPV4	95,00	1	004150432

415/C116



	€		
415/C116	700,00	1	004150450

415	Ø	n.
	1 - 1,5 - 2 - 2,5 - 3 - 3,5 - 4 - 4,5 - 5 mm	10
	5,5 - 6 - 6,5 - 7 - 7,5 - 8 mm	3
	8,5 - 9 - 9,5 - 10 mm	2

365x230x47 mm - 2,7 kg



	€		
415/SP91 Ø 1÷10 x 0,10 mm	979,00	1	004150460

416

broca cilíndrica, para furar chão,
com duas lâminas

R ≤ 900 N/mm²
HV ~ 820+850

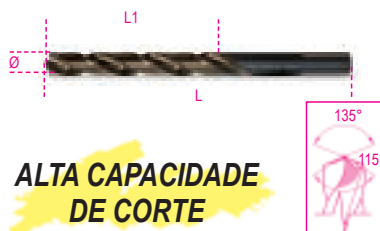

**ALTA CAPACIDADE
DE CORTE**

DIN 338

Ø mm	L mm	L1 mm	€		
1,00	34	12	2,25	10	004160010
1,50	40	18	2,25	10	004160015
2,00	49	24	2,25	10	004160020
2,50	57	30	2,35	10	004160025
3,00	61	33	2,55	10	004160030
3,50	70	39	2,85	10	004160035
4,00	75	43	3,20	10	004160040
4,50	80	47	3,50	10	004160045
5,00	86	52	3,95	10	004160050
5,50	93	57	5,10	10	004160055
6,00	93	57	5,55	10	004160060
6,50	101	63	6,45	10	004160065
7,00	109	69	7,55	10	004160070
7,50	109	69	8,10	5	004160075
8,00	117	75	9,60	5	004160080
8,50	117	75	10,40	5	004160085
9,00	125	81	12,40	5	004160090
9,50	125	81	13,00	5	004160095
10,00	133	87	15,00	5	004160100

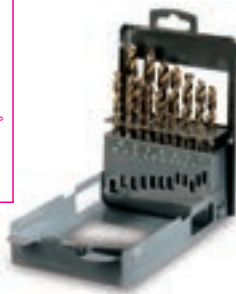
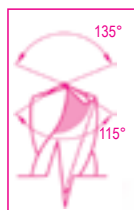

	€		
416/SP19 Ø 1÷10 x 0,5 mm	115,00	1	004160419

417

brocas cilíndricas para pedra,
série curta em aço fresado,
com ponta em diamante



DIN 8039

Ø mm	L mm	€		
3	70	3,10	10	004170003
4	75	3,10	10	004170004
5	85	3,25	10	004170005
5L	150	7,20	5	004170105
6	100	3,35	10	004170007
6L	150	7,20	5	004170106
7	120	3,75	10	004170009
8	120	4,15	10	004170010
8L	200	7,85	5	004170113
9	120	4,75	10	004170011
10	120	5,55	10	004170012
10L	200	9,50	5	004170120
12	150	7,35	10	004170014
12L	200	10,20	5	004170125
14	150	10,10	5	004170016
16	150	12,50	5	004170018



	€		
417/SP8 Ø 3-4-5-6-8-9-10-12 mm	46,50	1	004170100

419

brocas para pedra, corpo fresado
com ponta em diamante



DIN 8039

ØxL mm	€		
4x110	6,35	10	004190002
5x110	6,35	10	004190004
5x160	7,00	10	004190006
6x110	6,25	10	004190012
6x160	6,80	10	004190014
6x210	9,20	10	004190016
7x160	7,55	10	004190028
8x110	6,65	10	004190030
8x160	7,20	10	004190032
8x210	8,75	10	004190034
8x260	11,90	10	004190036
8x460	27,00	10	004190042
9x160	9,05	5	004190044
10x160	8,75	5	004190050
10x210	10,50	5	004190052
10x260	13,10	5	004190054
10x310	18,60	5	004190056
10x460	29,00	5	004190060
12x160	10,20	5	004190064
12x210	13,70	5	004190066
12x260	14,80	5	004190068
12x460	31,00	5	004190074
14x160	12,60	3	004190086
14x260	16,90	3	004190090
14x310	24,60	3	004190092
14x460	32,00	3	004190096
16x210	20,80	3	004190112
16x250	21,80	3	004190114
16x300	26,00	3	004190116
16x450	35,00	3	004190120
18x250	28,00	1	004190124
20x310	28,00	1	004190128

Beta



426SB/SP4	€ 202,00	1	004260130
426/SB1-426/SB2			
426/SB3-426/SB4			
Ø 2=20 mm			
426SB/SPV1	€ 21,30	1	004260135

426MD-3

Conjunto mini fresas rotativas em metal duro

• Corte transversal suave com quebras



	L mm	Ø mm	€	1	004260331
426MD-3/OV3	38,2	3	10,80	1	004260331
426MD-3/CP3	38,1	3	10,80	1	004260332
426MD-3/CT3	37,8	3	10,80	1	004260333
426MD-3/F3	38,3	3	10,80	1	004260334
426MD-3/TA3	38,3	3	10,80	1	004260335
426MD-3/T3	38,3	3	10,80	1	004260336
426MD-3/OG3	38,1	3	10,80	1	004260337
426MD-3/S3	38,0	3	10,80	1	004260338
426MD-3/FA3	38,2	3	10,80	1	004260339



426MD-3/FA9	€ 97,50	1	004260349
426MD-3/OV3 - 426MD-3/CP3			
426MD-3/CT3 - 426MD-3/F3			
426MD-3/TA3 - 426MD-3/T3			
426MD-3/OG3 - 426MD-3/S3			
426MD-3/FA3			

426MD

limas rotativas, em metal endurecido

corte transversal HM6



	L mm	Ø mm	€	1	004260531
426MD/OV6	50	6	31,50	1	004260531
426MD/OV9,5	61	9,5	38,50	1	004260541
426MD/OV12	67	12	53,50	1	004260521
426MD/OV16	69	16	65,50	1	004260551
426MD/CP6	50	6	31,50	1	004260532
426MD/CP8	63	8	34,50	1	004260512
426MD/CP9,5	63	9,5	38,50	1	004260542
426MD/CP12	69	12	53,50	1	004260522
426MD/CP16	69	16	76,00	1	004260552
426MD/CT6	50	6	31,50	1	004260533
426MD/CT8	63	8	34,50	1	004260513
426MD/CT9,5	63	9,5	38,50	1	004260543
426MD/CT12	69	12	53,50	1	004260523
426MD/CT16	69	16	76,00	1	004260553
426MD/F6	50	6	31,50	1	004260534
426MD/F8	63	8	34,50	1	004260514
426MD/F9,5	63	9,5	38,50	1	004260544
426MD/F12	69	12	53,50	1	004260524
426MD/F16	69	16	60,00	1	004260554
426MD/TA6	50	6	31,50	1	004260535
426MD/TA8	67	8	34,50	1	004260515
426MD/TA9,5	72	9,5	38,50	1	004260545
426MD/TA12	73	12	53,50	1	004260525
426MD/TA16	78	16	76,00	1	004260555
426MD/T6	50	6	31,50	1	004260536
426MD/T8	63	8	34,50	1	004260516
426MD/T9,5	63	9,5	38,50	1	004260546
426MD/T12	69	12	53,50	1	004260526
426MD/T16	70	16	60,00	1	004260556
426MD/OG6	50	6	31,50	1	004260537
426MD/OG8	63	8	34,50	1	004260517
426MD/OG10	70	10	38,50	1	004260547
426MD/OG12	76	12	53,50	1	004260527
426MD/OG16	81	16	76,00	1	004260557
426MD/S6	50	6	31,50	1	004260538
426MD/S8	51	8	34,50	1	004260518
426MD/S9,5	53	9,5	38,50	1	004260548
426MD/S12	56	12	53,50	1	004260528
426MD/S16	59	16	60,00	1	004260558
426MD/FA6	50	6	31,50	1	004260539
426MD/FA8	63	8	34,50	1	004260519
426MD/FA9,5	63	9,5	38,50	1	004260549
426MD/FA12	69	12	53,50	1	004260529
426MD/FA16	69	16	65,50	1	004260559



426MD/SP10	€ 393,00	1	004260510
426MD/CP-426MD/CT-426MD/F			
426MD/T-426MD/S			
Ø 8-12 mm			

427

extractores de cones Morse



DIN 317

GR	L mm	A mm	€	3	004270000
0	92	13	10,20	3	004270000
1-2	140	19	12,60	3	004270002
3	190	25	18,00	3	004270003
4	225	30	29,00	3	004270004
5-6	260	35	56,50	3	004270006

428FP

machos mecânicos para furos vazantes
passo largo em HSS



ISO 529

M	mm	L mm	L1 mm	€	10	004280003
3x0,5	2,7	56	11	15,00	10	004280003
4x0,7	3,4	63	13	15,00	10	004280004
5x0,8	4,9	70	16	15,00	10	004280005
6x1	4,9	80	19	15,90	10	004280006
8x1,25	6,2	90	22	19,10	10	004280008
10x1,5	8,0	100	24	22,40	10	004280010
12x1,75	7,0	110	29	29,50	5	004280012
14x2	9,0	110	30	36,00	5	004280014
16x2	9,0	110	30	43,50	5	004280016
18x2,5	11,0	125	34	56,00	3	004280018
20x2,5	12,0	140	34	63,00	3	004280020
22x2,5	14,5	140	34	75,50	3	004280022
24x3	14,5	160	38	82,00	3	004280024

428FC

machos mecânicos para furos cegos
passo largo em HSS



ISO 529

M	■ mm	L mm	L1 mm	€	🔧	📦
3x0,5	2,7	56	11	18,00	10	004280103
4x0,7	3,4	63	13	18,00	10	004280104
5x0,8	4,9	70	16	18,00	10	004280105
6x1	4,9	80	19	18,60	10	004280106
8x1,25	6,2	90	22	20,20	5	004280108
10x1,5	8,0	100	24	24,00	10	004280110
12x1,75	7,0	110	29	31,00	5	004280112
14x2	9,0	110	30	41,00	5	004280114
16x2	9,0	110	30	49,00	5	004280116
18x2,5	11,0	125	34	65,00	3	004280118
20x2,5	12,0	140	34	69,00	3	004280120
22x2,5	14,5	140	34	84,00	3	004280122
24x3	14,5	160	38	89,50	3	004280124

428/C14

jogo de 14 machos mecânicos
428FP+428FC



428/C14	€ 326,00	🔧 1	📦 004280201
428FP M3÷12			
428FC M3÷12			
428/SPV	€ 17,50	🔧 1	📦 004280202

429FP

machos mecânicos para furos vazantes
passo largo em HSS-CO 5%



ISO 529

M	■ mm	L mm	L1 mm	€	🔧	📦
3x0,5	2,7	56	11	19,70	5	004290003
4x0,7	3,4	63	13	19,70	5	004290004
5x0,8	4,9	70	16	19,70	5	004290005
6x1	4,9	80	19	21,30	5	004290006
8x1,25	6,2	90	22	23,50	5	004290008
10x1,5	8,0	100	24	27,50	5	004290010
12x1,75	7,0	110	29	35,00	5	004290012
14x2	9,0	110	30	46,00	5	004290014

429FC

machos mecânicos para furos cegos
passo largo em HSS-CO 5%

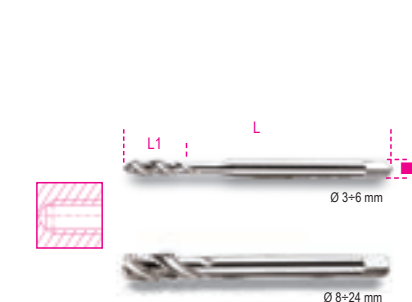

ISO 529

M	■ mm	L mm	L1 mm	€	🔧	📦
3x0,5	2,7	56	11	24,00	5	004290103
4x0,7	3,4	63	13	24,00	5	004290104
5x0,8	4,9	70	16	24,00	5	004290105
6x1	4,9	80	19	25,00	5	004290106
8x1,25	6,2	90	22	27,50	5	004290108
10x1,5	8,0	100	24	34,50	5	004290110
12x1,75	7,0	110	29	41,50	5	004290112
14x2	9,0	110	30	53,00	5	004290114

429/C14

jogo de 14 machos mecânicos
429FP+429FC



429/C14	€ 402,00	🔧 1	📦 004290201
429FP M3÷12			
429FC M3÷12			
428/SPV	€ 17,50	🔧 1	📦 004280202

430

machos manuais, passo largo
em aço ao cromo

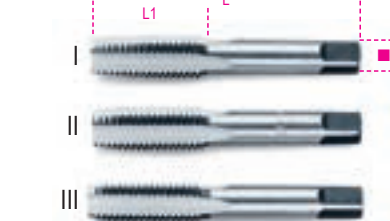

ISO 529

M	■ mm	L mm	L1 mm	€	🔧	📦
2x0,4	2,5	36	11	12,80	5	004300002
3x0,5	2,5	40	12	8,95	5	004300003
4x0,7	3,0	45	14	8,95	5	004300004
5x0,8	4,0	48	16	9,30	5	004300005
6x1	5,0	50	18	9,50	5	004300006
7x1	4,5	50	18	12,00	5	004300007
8x1,25	5,0	56	22	12,30	3	004300008
9x1,25	5,5	63	22	16,40	3	004300009
10x1,5	6,0	70	25	15,60	3	004300010
11x1,5	7,0	70	25	20,30	3	004300011
12x1,75	7,0	75	30	19,70	3	004300012
14x2	8,0	80	32	25,00	3	004300014
16x2	10,0	80	32	30,00	3	004300016
18x2,5	11,0	95	40	40,50	1	004300018
20x2,5	12,0	95	40	49,00	1	004300020
22x2,5	14,5	100	40	58,50	1	004300022
24x3	14,5	110	50	69,00	1	004300024



430/SP21	€ 112,00	🔧 1	📦 004300201
M 3-4-5-6-8-10-12			
430/SPV	€ 21,80	🔧 1	📦 004300202

430ASW

machos manuais rosca Whitworth
em aço ao cromo

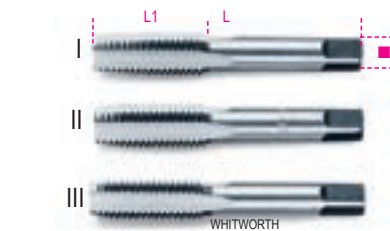

DIN 352

BSW	■ mm	L mm	L1 mm	€	🔧	📦
1/8x40	2,7	40	12	8,85	5	004300031
5/32x32	3,4	45	14	8,85	5	004300032
3/16x24	4,3	48	18	8,85	5	004300033
1/4x20	4,9	50	22	10,20	5	004300034
5/16x18	4,9	56	25	12,60	3	004300035
3/8x16	5,5	70	28	16,40	3	004300036
7/16x14	6,2	70	30	18,60	3	004300037
1/2x12	7,0	75	32	20,80	3	004300038
9/16x12	9,0	80	32	25,00	1	004300039
5/8x11	9,0	80	38	31,00	1	004300040
3/4x10	11,0	95	40	44,00	1	004300041
7/8x9	14,5	100	40	56,00	1	004300042
1"x8	16,0	110	50	71,50	1	004300043

435G

desandadores de machos extensíveis
corpo em liga leveira



DIN 1814

	□ mm	L mm	€		
435G/0	2÷5 M1÷M8	130	10,70	5	004350108
435G/1	2÷6 M1÷M10	190	13,10	5	004350110
435G/1,5	2÷7 M2÷M12	175	13,80	5	004350112
435G/2	3,4÷7 M4÷M12	280	22,60	5	004350114
435G/3	4,9÷12 M5÷M20	380	37,00	2	004350121
435G/4	7÷16 M11÷M27	500	58,50	2	004350127
435G/5	7÷18 M13÷M32	700	93,00	1	004350132
435G/6	11÷24 M18÷M42	800	152,00	1	004350142

436

punhos desandadores de machos
com roquete reversível

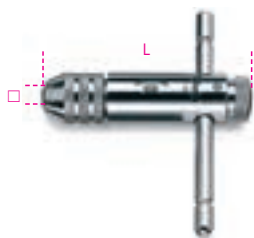

	□ mm	L mm	€		
436/1	2÷5 M3÷M8	85	25,50	5	004360002
436/2	4,6÷8 M5÷M12	110	32,50	5	004360004

436L

punhos desandadores de machos
com roquete reversível, tipo longo



	□ mm	L mm	€		
436L/1	2÷5 M3÷M8	245	40,00	2	004360012
436L/2	4,6÷8 M5÷M12	295	47,50	2	004360014

436R

buchas de substituição
para artigos 436 e 436L

	€		
436R/1	4,70	1	004360022
436R/2	5,25	1	004360024

437C

jogo para reparação de roscas de velas de
ignição, M14x1.25 mm

• Altura helicoidal: 8.40 - 12.40 - 16.40 mm (5 pcs/tamanho)



	€		
437C	106,50	1	004370100

437C/...

helicóides em aço inoxidável para ref. 437C



H mm	€		
8.4	26,00	1	004370108
12.4	26,00	1	004370112
16.4	26,00	1	004370116

Os preços indicados são para 10 unidades

437C/RM14

macho para velas de ignição M14x1.25



	€		
437C/RM14	88,00	1	004370124

437K/8

kit reparação
de veios roscados

• Permite rectificar e corrigir a rosca original.

O kit inclui:

• tamanhos métricos:

20x1.25 - 20x1.5 - 22x1.00 - 22x1.5 - 24x1.5 - 24x2.00

• tamanhos polegadas:

3/4x20 - 13/16x20



○ 32 mm

	€		
437K/8	70,50	1	004370020

☞ 200x110x30 mm

437K/16

jogo de ferramentas para reparação de
fios danificados em pinças de travão M9x1.25



	€		
437K/16	99,00	1	004370016

☞ 210x150x50 mm

437K/33

jogo de ferramentas para reparação de
fios de vela danificados

Casquilhos:

M8x1.0 - M10x1.0 - M10x1.25 - M12x1.25

Derivações:

M8x1.0 - M10x1.0 - M10x1.25 - M12x1.0 - M12x1.25 - M14x1.25



	€		
437K/33	246,00	1	004370133

☞ 210x150x50 mm

437U/09

Kit para reparação de roscas danificadas
M5-M6-M8-M10-M12



25 x M5, M6, M8, M10
10 x M12

	€		
437U/09	299,00	1	004370550

M5X0,8
M6X1,0
M8X1,25
M10X1,5
M12X1,75

☞ 370x230x55 mm - 2 Kg

Beta

446/C30

jogo de machos e caçonetos em aço ao cromo e acessórios rosca métrica em caixa de madeira



446/C30 € 278,00 1 004460055

500x337x60 mm - 8,1 Kg

430 M	440 M	435/1,5	444/1
3x0,5	3x0,5		
4x0,7	4x0,7		
5x0,8	5x0,8		
6x1	6x1		
8x1,25	8x1,25		
10x1,5	10x1,5		
12x1,75	12x1,75		

446/C48

jogo de machos e caçonetos em aço ao cromo e acessórios rosca métrica em caixa de madeira



446/C48 € 527,00 1 004460057

580x300x50 mm - 5 Kg

430 M	440 M	440A M	435/1	444/1
3x0,5	3x0,5	10x1,5	435/1	444/1
4x0,7	4x0,7	12x1,75	435/3	444/2
5x0,8	5x0,8	14x2		
6x1	6x1	16x2		
8x1,25	8x1,25	18x2,5		
10x1,5		20x2,5		
12x1,75				
14x2				
16x2				
18x2,5				
20x2,5				

446/C110

jogo de machos e caçonetos em aço ao cromo e acessórios rosca métrica em caixa de madeira



446/C110 € 774,00 1 004460060

500x337x60 mm - 8,1 Kg

430 M	433 M	440/440A, 441/441A, M	441A, M
2x0,4	6x0,75	2x0,4	6x0,75
3x0,5	7x0,75	3x0,5	7x0,75
4x0,7	8x0,75	4x0,7	8x0,75
5x0,8	8x1	5x0,8	8x1
6x1	9x0,75	6x1	9x0,75
7x1	9x1	7x1	9x1
8x1,25	10x0,75	8x1,25	10x0,75
9x1,25	10x1	9x1,25	10x1
10x1,5	10x1,25	10x1,5	10x1,25
11x1,5	11x0,75	11x1,5	11x0,75
12x1,75	11x1	12x1,75	11x1
14x2	11x1,25	14x2	11x1,25
16x2	12x0,75	16x2	12x0,75
	12x1		12x1
	12x1,25		12x1,25
	12x1,5		12x1,5
	14x1		14x1
	14x1,25		14x1,25
	14x1,5		14x1,5
	16x1		16x1
	16x1,5		16x1,5
	18x1,5		18x1,5

435/0	444/1	436/1
435/3	444/2	

446ASF/C29

jogo de machos e caçonetos em aço ao cromo e acessórios rosca UNF em caixa de madeira



446ASF/C29 € 602,00 1 004460070

660x410x50 mm - 6 Kg

433ASF	440ASF	435/1,5	444/1
1/4	1/4	435/1,5	444/1
5/16	5/16	435/3	444/2
3/8	3/8		444/3
7/16	7/16		
1/2	1/2		
9/16	9/16		
5/8	5/8		
3/4	3/4		

446ASW/C36

jogo de machos e caçonetos em aço ao cromo e acessórios rosca Whitworth em caixa de madeira



446ASW/C36 € 453,00 1 004460075

525x310x50 mm - 3,4 Kg

430ASW	440ASW	435/1,5	444/1
1/8	1/8	435/1,5	444/1
5/32	5/32	435/2	444/2
3/16	3/16		
1/4	1/4		
5/16	5/16		
3/8	3/8		
7/16	7/16		
1/2	1/2		

 **Beta**

446ASC/C37

jogo de machos e caçonetos em aço ao crómio e acessórios rosca **UNC** em caixa de madeira



446ASC/C37 € 646,00 1 004460080

≡ 660x410x50 mm - 6,7 Kg

430ASC	440ASC		
1/4	1/4	435/1,5	444/1
5/16	5/16	435/3	444/2
3/8	3/8		444/3
7/16	7/16		
1/2	1/2		
9/16	9/16		
5/8	5/8		
3/4	3/4		

446ASG/C23

jogo de machos e caçonetos em aço ao crómio e acessórios rosca **GAS** cilíndrica em caixa de madeira



446ASG/C23 € 946,00 1 004460085

≡ 700x430x70 mm - 9,8 Kg

433ASG	440ASG		
1/8	1/8	435/3	444/2
1/4	1/4	435/5	444/3
3/8	3/8		444/5A
1/2	1/2		
3/4	3/4		
1"	1"		

447/C37

jogo de machos e caçonetos em HSS e acessórios rosca métrica em caixa de metálica



447/C37 € 566,00 1 004470055

≡ 380x185x35 mm - 3,9 Kg

431 M	442 M		
3x0,5	3x0,5	435/0	444
4x0,7	4x0,7	435/2	444/0
5x0,8	5x0,8		444/1A
6x1	6x1		444/1B
8x1,25	8x1,25		444/1C
10x1,5	10x1,5		
12x1,75	12x1,75		

436/1	0,5x3x75
-------	----------

447/C53

jogo de machos e caçonetos em HSS e acessórios rosca métrica em caixa de metálica



447/C53 € 1.178,00 1 004470060

≡ 500x235x50 mm - 9 Kg

431 M	442 M			
3x0,5	3x0,5	435/1,5	444	436/1
4x0,7	4x0,7	435/3	444/0	436/2
5x0,8	5x0,8		444/1A	
6x1	6x1		444/1B	
8x1,25	8x1,25		444/1C	
10x1,5	10x1,5		444/2D	
12x1,75	12x1,75			
14x2	14x2			
16x2	16x2			
18x2,5	18x2,5			
20x2,5	20x2,5			

447/C70

jogo de machos e caçonetos em HSS e acessórios rosca métrica em caixa de madeira



447/C70 € 1.455,00 1 004470065

≡ 510x340x70 mm - 7,5 Kg

431 M	434 M	442 M	443 M
3x0,5	8x1	3x0,5	8x1
4x0,7	10x1,25	4x0,7	10x1,25
5x0,8	12x1,25	5x0,8	12x1,25
6x1	12x1,5	6x1	12x1,5
7x1	14x1,25	7x1	14x1,25
8x1,25	14x1,5	8x1,25	14x1,5
10x1,5	16x1,5	10x1,5	16x1,5
12x1,75		12x1,75	
14x2		14x2	
16x2		16x2	

435/0	444	436/1
435/3	444/0	
	444/1A	
	444/1B	
	444/1C	
	444/1D	

450

brocas cranianas em HSS bi-metal

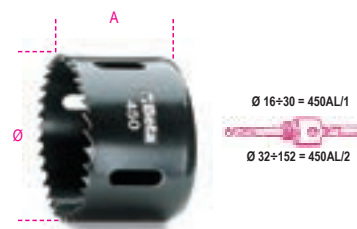

Ø 16+30 = 450AL/1

Ø 32+152 = 450AL/2

HSS-Co 8%

Ø mm	Ø	A mm	€		
16	(5/8)	57	15,30	1	004500016
17	(11/16)	57	15,30	1	004500017
19	(3/4)	51	15,30	1	004500019
20	-	51	15,30	1	004500020
21	(13/16)	51	15,30	1	004500021
22	(7/8)	51	15,30	1	004500022
24	(15/16)	51	15,30	1	004500024
25	(1")	51	16,10	1	004500025
27	(1 1/16)	51	16,40	1	004500027
29	(1 1/8)	51	16,40	1	004500029
30	(1 3/16)	51	16,40	1	004500030
32	(1 1/4)	51	16,90	1	004500032
33	(1 5/16)	51	16,90	1	004500033
35	(1 3/8)	51	19,30	1	004500035
37	(1 7/16)	51	19,30	1	004500037
38	(1 1/2)	44	19,70	1	004500038

Ø mm	Ø"	A mm	€	🔧	📦
40	(1"9/16)	44	20,20	1	004500040
41	(1"5/8)	44	20,80	1	004500041
43	(1"11/16)	44	20,80	1	004500043
44	(1"3/4)	44	22,10	1	004500044
46	(1"13/16)	44	22,10	1	004500046
48	(1"7/8)	44	22,60	1	004500048
51	(2")	44	22,90	1	004500051
52	(2"1/16)	44	26,00	1	004500052
54	(2"1/8)	44	26,00	1	004500054
57	(2"1/4)	44	26,00	1	004500057
59	(2"5/16)	44	27,00	1	004500059
60	(2"3/8)	44	27,00	1	004500060
64	(2"1/2)	44	28,50	1	004500064
65	(2"9/16)	44	28,50	1	004500065
67	(2"5/8)	44	28,50	1	004500067
68	-	44	28,50	1	004500068
70	(2"3/4)	44	29,00	1	004500070
73	(2"7/8)	44	29,00	1	004500073
76	(3")	44	30,00	1	004500076
79	(3"1/8)	44	31,00	1	004500079
83	(3"1/4)	44	32,00	1	004500083
86	(3"3/8)	44	33,00	1	004500086
89	(3"1/2)	44	34,00	1	004500089
92	(3"5/8)	44	35,50	1	004500092
95	(3"3/4)	44	38,50	1	004500095
98	(3"7/8)	44	39,50	1	004500098
102	(4")	44	40,50	1	004500102
105	(4"1/8)	44	44,00	1	004500105
108	(4"1/4)	44	57,00	1	004500108
111	(4"3/8)	44	65,00	1	004500111
114	(4"1/2)	44	76,50	1	004500114
121	(4"3/4)	44	84,50	1	004500121
127	(5")	44	93,50	1	004500127
140	(5"1/2)	44	113,00	1	004500140
152	(6")	44	131,00	1	004500152

450AL

buchas para brocas cranianas

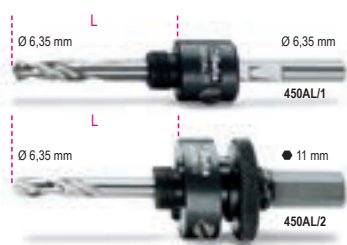

	Ø mm	L mm	€	🔧	📦
450AL/1	16÷30	54	18,00	1	004500210
450AL/2	32÷152	70	43,50	1	004500215

450AD

adaptador bucha/broca craniana 450AL/1



	Ø mm	€	🔧	📦
450AD	32÷51	7,10	1	004500230

450PA/1

brocas para buchas em HSS para 450AL/1



ØxL mm	€	🔧	📦
6,35x105	10,90	1	004500252

450PA/2

brocas para buchas em HSS para 450AL/2

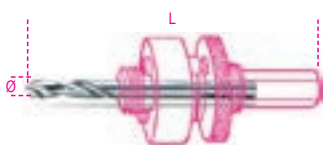

ØxL mm	€	🔧	📦
6,35x80	10,90	1	004500253

450PR

extensão para brocas cranianas



L mm	€	🔧	📦
305	31,50	1	004500255

450/C9

jogo de brocas cranianas e acessórios para electricista



HSS-Co 8%

450/C9	€	🔧	📦
	218,00	1	004500305

450 Ø 22 - 29 - 35 - 44 - 51 - 64 mm
450AL /1 - /2
450AD

220x160x60 mm - 1,6 Kg

450/C13

jogo de brocas cranianas e acessórios para instaladores



HSS-Co 8%

450/C13	€	🔧	📦
	273,00	1	004500310

450 Ø 19 - 22 - 29 - 35 - 38
44 - 51 - 57 - 64 mm

450AL /1 - /2

450PA/1

450AD

215x180x65 mm - 1,8 Kg

450/C15

Sortido de serras e acessórios para eléctricos



450/C15	€	🔧	📦
	349,00	1	004500313

450 Ø 16 - 20 - 25 - 32 - 40
51 - 60 - 65 - 70 mm

450AL /1 - /2

450PA /1 - /2

450PR

450AD

420x185x60 mm - 3,2 Kg

560/C4+

Multiplicador de binário,
relação 5:1, com efeito bloqueio

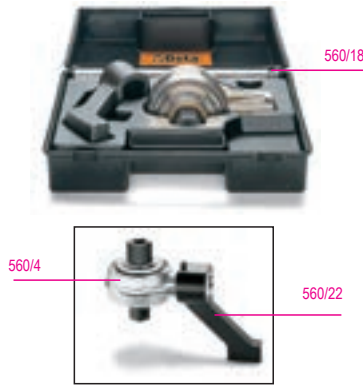

Nm	Kgfm	lbf.ft	□	■	kg
2700	270	2000	3/4"	1"	5

	€			
560/C4PLUS	1.535,00	1	005600042	
560/4	1.210,00	1	005600004	
560/18	35,50	1	005600018	
560/22	270,00	1	005600022	

≡ 310x275x120 mm

560/C6

Multiplicador de binário para aperto a esquerda e a direita em caixa plástica
Relação: 6.5:1



Nm	Kgfm	lbf.ft	□	■	kg
1500	150	1106	1/2"	3/4"	6

	€			
560/C6	796,00	1	005600160	

≡ 400x260x110 mm

560/C12

Multiplicador de binário para aperto a esquerda e a direita em caixa plástica
Relação: 12:1



Nm	Kgfm	lbf.ft	□	■	kg
2500	250	1844	1/2"	1"	7

	€			
560/C12	1.156,00	1	005600210	

≡ 400x260x110 mm

561/1

multiplicador de binário,
relação 5:1 com duas uniões de reação

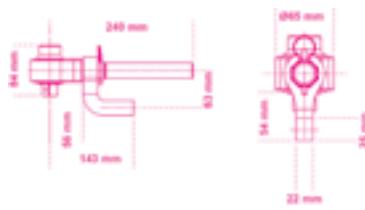

Nm	Kgfm	lbf.ft	□	■	kg
1000	100	740	1/2"	3/4"	2,7

	€			
561/1	1.101,00	1	005610010	

≡ 270x210x70 mm

562/1 - 562/2

multiplicadores de binário relação 5:1

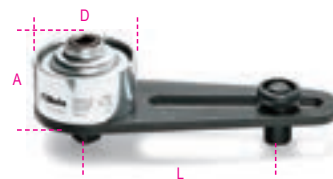

Nm	Kgfm	lbf.ft	□	■	D	A	L min	L max	kg
1700	170	1250	3/4"	1"	108	95	85	220	5,3

	€			
562/1	2.440,00	1	005620001	

Nm	Kgfm	lbf.ft	□	■	D	A	L min	L max	kg
3400	340	2500	3/4"	1"	119	115	85	265	7,0

	€			
562/2	3.000,00	1	005620002	

564/3R - 564/4R

multiplicadores de binário
com pé de apoio relação 25:1
com sistema anti-retorno



Nm	Kgfm	lbf.ft	□	■	D	A	L	kg
3000	300	2200	1/2"	1"	108	188	155	9,2

	€			
564/3R	4.950,00	1	005640003	

Nm	Kgfm	lbf.ft	□	■	D	A	L	kg
6000	600	4500	1/2"	1 1/2"	119	235	200	15,5

	€			
564/4R	5.890,00	1	005640004	

565/1R - 565/2R - 565/3R

multiplicadores de binário relação 25:1
com sistema anti-retorno



Nm	Kgfm	lbf.ft	□	■	D	A	L min	L max	kg
1700	170	1250	1/2"	1"	108	125	80	215	7,7

	€			
565/1R	4.070,00	1	005650011	

Nm	Kgfm	lbf.ft	□	■	D	A	L min	L max	kg
3400	340	2500	1/2"	1"	119	145	85	265	10,1

	€			
565/2R	5.350,00	1	005650012	

Nm	Kgfm	lbf.ft	□	■	D	A	L min	L max	kg
3400	340	2500	1/2"	1 1/2"	119	145	85	265	10,7

	€			
565/3R	5.670,00	1	005650013	

565/4R

multiplicadores de binário **relação 25:1**
com sistema anti-retorno

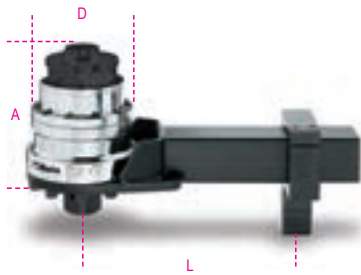

Nm	Kgfm	lbf.ft	□	■	D	A	L min	L max	📏
6000	600	4500	1/2	1 1/2	144	180	125	335	17

565/4R € 6.350,00 1 005650014

565/5R

multiplicadores de binário **relação 25:1**
com sistema anti-retorno

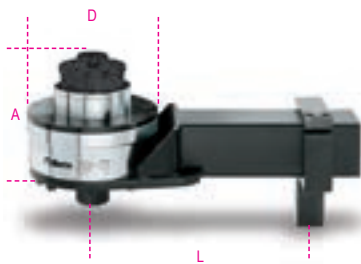

Nm	Kgfm	lbf.ft	□	■	D	A	L min	L max	📏
9500	950	7000	3/4	1 1/2	184	180	155	355	25

565/5R € 11.100,00 1 005650015

567/4R

multiplicadores de binário **relação 125:1**
com sistema anti-retorno

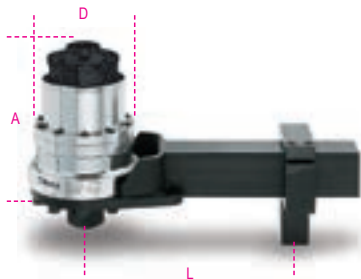

Nm	Kgfm	lbf.ft	□	■	D	A	L min	L max	📏
6000	600	4500	1/2	1 1/2	144	210	125	335	19

567/4R € 7.120,00 1 005670014

567/5R

multiplicadores de binário **relação 125:1**
com sistema anti-retorno

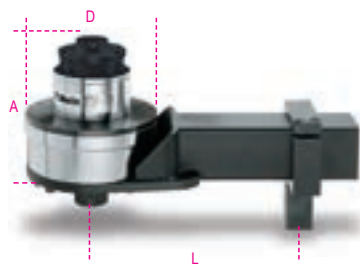

Nm	Kgfm	lbf.ft	□	■	D	A	L min	L max	📏
9500	950	7000	1/2	1 1/2	184	210	155	350	27

567/5R € 12.510,00 1 005670015

581

aparafusadora dinâmétrica não graduada
para apertos à direita
precisão: $\pm 6\%$
(para utilização com artigos 588 - 682)



UNI EN ISO 6789

Nm	gfm	○	📏
1,2÷6	120÷600	1/4"	275

581 € 249,00 1 005810001

583

aparafusadora dinâmétrica graduada
para apertos à direita
precisão: $\pm 6\%$



UNI EN ISO 6789

Nm	gfm	○	📏
0,3÷1,5	30÷150	1/4"	240

583/1,5 € 280,00 1 005830015

Nm	gfm	○	📏
0,6÷3	60÷300	1/4"	240

583/3 € 280,00 1 005830030

Nm	gfm	○	📏
1,2÷6	120÷600	1/4"	350

583/6 € 280,00 1 005830060

583/C31

1 aparafusadora dinâmétrica, 8 chaves de caixa manuais sextavadas, 20 bits e 2 acessórios



583/C31 € 389,00 1 005830931

583/6	1.2 - 6 Nm
900	4-5-5,5-6-7-8-9-10 mm
860LP	0,6x4,5 - 1x5,5 - 1,2x6,5 mm
860PH	PH1 - PH2 (x2) - PH3
860PE	2-2,5-3-4-5 mm
860TX	T9-T10-T15-T20-T25-T27-T30-T40
882P/80	80 mm
892/0	● 1/4 ■ 1/4

270x120x45 mm - 📏 1,2 kg

588

medidor de binário electrónico

para testar e calibrar aparafusadoras dinâmétricas 581-583
Precisão: $\pm 1\%$



Nm	lbf.in	□	📏
1÷10	10÷90	1/4"	1,8

588 € 1.885,00 1 005880001

590 - 592

chaves dinâmétricas de leitura directa
para aperto direito e esquerdo
precisão: $\pm 4\%$

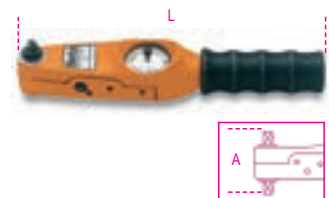

UNI EN ISO 6789

Nm	Kgfm	lbf.in	■	A	L	📏
0,3÷4	0,03÷0,4	3÷35	1/4	60	253	0,52

590 € 665,00 1 005900001

Nm	Kgfm	lbf.in	■	A	L	📏
0,5÷13,5	0,05÷1,35	4÷120	1/4	60	253	0,52

590/1 € 665,00 1 005900003

599DGT-AN

chave dinamométrica eletrônica, leitura do binário e ângulo, com roquete reversível, para aperto à direita (precisão: $\pm 2\%$) e à esquerda (precisão: $\pm 3\%$)

- tipos de aperto: binário, ângulo, binário + ângulo
- modo de medição duplo: pico e curso
- indicador luminoso e sinal acústico informam o utilizador que o valor pré-seleccionado foi atingido
- armazenamento de dados (até 250 valores)
- predefinição até 9 valores binário/ângulo
- bloqueio de segurança
- permite inserir 16 utilizadores diferentes através da ID de utilizador
- rastreabilidade de dados. O software permite armazenar e associar à ID de utilizador a data e hora, número de série da ferramenta, valor de aperto definido e valor alcançado
- punho de dois componentes antiderrapante
- inclui: 2 pilhas AA - 1.5V, cabo USB e software



UNI EN 26789
ISO 6789

Nm	Kgfm	lbf.ft	D	A	L	kg	
20÷100	2÷10	15÷80	1/2	30	33	413	0,9

599DGT-AN/10 € 649,00 1 005990610

Nm	Kgfm	lbf.ft	D	A	L	kg	
40÷200	4÷20	30÷150	1/2	40	43	520	1,3

599DGT-AN/20 € 687,00 1 005990620

Serviço de calibração de binário no final

Nm	Kgfm	lbf.in	A	L	kg	
1÷27	0,1÷2,7	10÷240	3/8	70	253	0,52

592/3 € 662,00 1 005920005

Nm	Kgfm	lbf.in	A	L	kg	
3÷40	0,3÷4	20÷360	3/8	70	253	0,52

592/4 € 662,00 1 005920007

Tabela de campos de aplicação de chaves e barras dinamométricas no final

594

chaves dinamométricas de leitura directa para aperto direito e esquerdo precisão: $\pm 4\%$

12"



UNI EN ISO 6789

Nm	Kgfm	lbf.ft	A	L	kg	
6÷80	0,6÷8	5÷60	1/2	85	455	1,35

594/8 € 996,00 1 005940011

Nm	Kgfm	lbf.ft	A	L	kg	
20÷215	2÷21,5	15÷160	1/2	85	530	1,40

594/21 € 996,00 1 005940015

596 - 598

chaves dinamométricas de leitura directa para aperto direito e esquerdo precisão: $\pm 4\%$

Com avisadores luminosos e sonoros na medida pré-definida

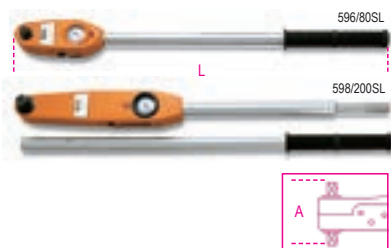

UNI EN ISO 6789

Nm	Kgfm	lbf.ft	A	L	kg	
80÷400	8÷40	60÷300	3/4	111	710	3,2

596/40SL € 1.665,00 1 005960010

Nm	Kgfm	lbf.ft	A	L	kg	
160÷800	16÷80	120÷600	3/4"	115	1025	4,85

596/80SL € 2.100,00 1 005960020

Nm	Kgfm	lbf.ft	A	L	kg	
200÷2000	20÷200	150÷1500	1"	135	1930	16,70

598/200SL € 4.360,00 1 005980022

Serviço de calibração de binário no final

599DGT

chave eletrônica com roquete reversível, aperto à direita (precisão: $\pm 2\%$) e à esquerda (precisão: $\pm 3\%$)

- Modo de medição dupla: pico e curso
- Indicadores luminosos e acústicos informam o utilizador que o valor pré-seleccionado foi atingido
- Alimentação: 2 pilhas 1.5V (incluídas)



UNI EN ISO 6789

Nm	Kgfm	lbf.ft	D	A	L	kg	
12÷60	1,2÷6	8÷44	3/8	30	33	413	0,9

599DGT/6 € 348,00 1 005990003

Nm	Kgfm	lbf.ft	D	A	L	kg	
20÷100	2÷10	15÷80	1/2	30	37	413	0,9

599DGT/10X € 359,00 1 005990010

Nm	Kgfm	lbf.ft	D	A	L	kg	
40÷200	4÷20	30÷150	1/2	40	43	520	2

599DGT/20 € 374,00 1 005990020

Nm	Kgfm	lbf.ft	D	A	L	kg	
68÷340	6,8÷34	58÷280	1/2	40	43	640	2,35

599DGT/30 € 403,00 1 005990030

600

chaves de aperto angular

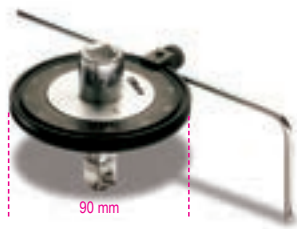

	□	■	€	🔧	📦
600/1	1/2	1/2	140,00	1	006000001
600/2	3/4	3/4	157,00	1	006000002

601C

indicador digital ângulo de aperto

Indicador luminoso e um sinal sonoro informam o utilizador que o ângulo programado já foi alcançado

CE



	€	🔧	📦
601C	188,00	1	006010100

85x80x87 mm - 70 g

601CA

indicador digital ângulo e binário de aperto

Indicador luminoso e um sinal sonoro informam o utilizador que o ângulo programado já foi alcançado

12"

CE



	□	■	Nm	€	🔧	📦
601CA	1/2"	1/2"	10÷200	336,00	1	006010120

120x90x120 mm - 240 g

603

chaves dinamométricas com embraiagem de segurança para aperto à direita
precisão: ±6%

1/4"



UNI EN ISO 6789

Nm	Kgfm	lbf.in	■	A mm	L mm	g
1÷5	0,1÷0,5	10÷45	1/4	35	195	235

	€	🔧	📦
603/5	567,00	1	006030005

Nm	Kgfm	lbf.in	■	A mm	L mm	g
2÷10	0,2÷1,0	18÷90	1/4	35	195	235

	€	🔧	📦
603/10	578,00	1	006030010

604B

barra dinamométrica para aperto à direita e à esquerda
precisão de aperto: ± 6%



UNI EN ISO 6789

Nm	kgfm	lbf.in	∅ mm	L mm	g
1÷5	0,1÷0,5	10÷45	8	220	290

	€	🔧	📦
604B/5	368,00	1	006040015

Nm	Kgfm	lbf.in	∅ mm	L mm	g
2÷10	0,2÷1,0	18÷90	8	220	300

	€	🔧	📦
604B/10	368,00	1	006040020

605E

chaves dinamométricas com desarme sonoro, roquete reversível de aperto à direita e à esquerda
precisão: ± 6%

1/4"



UNI EN ISO 6789

Nm	Kgfm	lbf.in	■	A mm	L mm	g
1÷5	0,1÷0,5	10÷45	1/4	20	190	180

	€	🔧	📦
605E/5	187,00	1	006050105

Nm	Kgfm	lbf.in	■	A mm	L mm	g
2÷10	0,2÷1,0	18÷90	1/4	20	190	180

	€	🔧	📦
605E/10	197,00	1	006050110

611

roquete reversível para barras dinamométricas refs. 604B/5 e 604B/10
encabadouro 8 mm

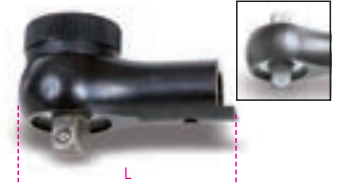

■	L mm	€	🔧	📦
1/4	42,5	131,00	1	006110001

Serviço de calibração de binário no final

612 ÷ 614

roquetes reversíveis para barras dinamométricas



As referências 612 e 612X não podem ser usados em apertos cujo torque exceda 100 Nm

	■	L mm	LA mm	€	🔧	📦
612	3/8	66	32	59,00	2	006120000
612X	1/2	66	32	63,50	2	006120010
614	1/2	71	32	68,50	2	006140000
614X	3/4	71	32	76,50	2	006140004

614/50

roquete simples para barras dinamométricas



	■	L mm	LA mm	€	🔧	📦
614/50	1/2	71	32	63,00	2	006140002

Ver quadro depois do artigo 929/C8 para acessórios compatíveis usados

Beta

mm	mm	L mm	LA mm	€		
13	14x18	61	39,8	52,50	1	006530113
14	14x18	61	39,8	52,50	1	006530114
15	14x18	62	39,8	52,50	1	006530115
16	14x18	63	39,8	53,00	1	006530116
17	14x18	64	39,8	53,00	1	006530117
18	14x18	64	39,8	53,00	1	006530118
19	14x18	66	39,8	53,00	1	006530119
21	14x18	66	39,8	78,50	1	006530121
22	14x18	67	39,8	78,50	1	006530122
24	14x18	69	39,8	97,50	1	006530124
*27	14x18	76	44,8	97,50	1	006530127
*30	14x18	77	44,8	97,50	1	006530130
*32	14x18	79	44,8	97,50	1	006530132
*34	14x18	80	44,8	140,00	1	006530134
*36	14x18	80	44,8	140,00	1	006530136
*41	14x18	90	49,8	140,00	1	006530141

*Atenção! Recalcular o valor do binário conforme indicado na tabela que se encontra no fim do catálogo

666N

chaves dinamométricas com roquetes reversíveis, para aperto à direita, precisão de torque: $\pm 3\%$



UNI EN ISO 6789

Nm	Kgfm	lbf.ft	mm	D mm	A mm	L mm	g
5÷25	0,5÷2,5	4÷18	1/4	25	29	220	300
666N/2 286,00 1 006660002							
5÷25	0,5÷2,5	4÷18	3/8	25	29	220	300
666N/2X 293,00 1 006660003							
10÷50	1÷5	7÷37	3/8	30	33	325	660
666N/5 211,00 1 006660005							
20÷100	2÷10	15÷75	3/8	30	33	367	730
666N/10 213,00 1 006660010							
20÷100	2÷10	15÷75	1/2	30	37	367	800
666N/10X 217,00 1 006660011							
40÷200	4÷20	30÷150	1/2	40	43	465	1010
666N/20 232,00 1 006660020							
60÷300	6÷30	50÷220	1/2	40	43	581	1380
666N/30 264,00 1 006660030							

666N LBF.IN

chaves dinamométricas com roquetes reversíveis, para aperto à direita, precisão de torque: $\pm 3\%$

• Escala em libras, força por polegada



UNI EN ISO 6789

lbf.in	mm	D mm	A mm	L mm	g
90÷440	3/8	30	33	325	660
666N-LBF.IN/5 211,00 1 006660055					
200÷800	3/8	30	33	367	730
666N-LBF.IN/10 213,00 1 006660070					
200÷800	1/2	30	37	367	800
666N-LBF.IN/10X 217,00 1 006660071					
400÷1800	1/2	40	43	465	1010
666N-LBF.IN/20 232,00 1 006660072					
500÷3000	1/2	40	43	581	1380
666N-LBF.IN/30 264,00 1 006660073					



667N

chaves dinamométricas para operações à esquerda e à direita, precisão de torque: $\pm 3\%$



UNI EN ISO 6789

Nm	Kgfm	lbf.ft	mm	D mm	A mm	L mm	g
40÷200	4÷20	30÷150	1/2	40	43	465	1010
667N/20 224,00 1 006670020							
60÷300	6÷30	50÷220	1/2	40	43	581	1380
667N/30 249,00 1 006670030							
80÷400	8÷40	60÷295	3/4	50	50	687	2090
667N/40 605,00 1 006670040							

Ver quadro depois do artigo 929/C8 para acessórios compatíveis usados

668N

barras de aperto, para operações à esquerda e à direita, precisão de torque: $\pm 3\%$



UNI EN ISO 6789

Nm	Kgfm	lbf.ft	mm	Ø mm	L mm	LB mm	LS mm	g
5÷25	0,5÷2,5	4÷18	16	220	148	32	300	
668N/2 213,00 1 006680002								
10÷50	1÷5	7÷37	16	307	229	32	590	
668N/5 208,00 1 006680005								
20÷100	2÷10	15÷75	16	376	269	32	670	
668N/10 212,00 1 006680010								

Nm	Kgfm	lbf.ft	Ø mm	L mm	LB mm	LS mm	g
40÷200	4÷20	30÷150	16	450	352,6	32	795
668N/20					229,00		1 006680020

Nm	Kgfm	lbf.ft	Ø mm	L mm	LB mm	LS mm	g
60÷300	6÷30	50÷220	16	588	475,9	32	1230
668N/30					262,00		1 006680030

668RG

barra dinamométrica não graduada para apertos à direita e à esquerda
precisão: ±4%
(para utilização com artigos 680 - 682)



UNI EN ISO 6789

Nm	Kgfm	lbf.ft	Ø mm	L mm	g	
8÷60	0,8÷6	6÷44	16	288	550	
668RG/6					169,00	1 006680206

Nm	Kgfm	lbf.ft	Ø mm	L mm	g	
20÷100	2÷10	15÷80	16	315	600	
668RG/10					174,00	1 006680210

Nm	Kgfm	lbf.ft	Ø mm	L mm	g	
40÷200	4÷20	30÷150	16	405	780	
668RG/20					186,00	1 006680220

Nm	Kgfm	lbf.ft	Ø mm	L mm	g	
60÷300	6÷30	50÷220	16	645	1130	
668RG/30					209,00	1 006680230

669N

barras dinamométricas, encabadouro rectangular, para operações à esquerda e à direita, precisão de torque: ±3%



UNI EN ISO 6789

Nm	Kgfm	lbf.ft	□ mm	L mm	LB mm	LS mm	g	
5÷25	0,5÷2,5	4÷18	9x12	215	140	28,8	300	
669N/2							301,00	1 006690202

Nm	Kgfm	lbf.ft	□ mm	L mm	LB mm	LS mm	g	
10÷50	1÷5	7÷37	9x12	307	226,8	28,8	590	
669N/5							233,00	1 006690205

Nm	Kgfm	lbf.ft	□ mm	L mm	LB mm	LS mm	g	
20÷100	2÷10	15÷75	9x12	376	266,8	28,8	670	
669N/10							249,00	1 006690210

Nm	Kgfm	lbf.ft	□ mm	L mm	LB mm	LS mm	g	
40÷200	4÷20	30÷150	9x12	450	345,6	28,8	795	
669N/20							299,00	1 006690220

Nm	Kgfm	lbf.ft	□ mm	L mm	LB mm	LS mm	g	
40÷200	4÷20	30÷150	14x18	450	351	39,8	795	
669N/20X							317,00	1 006690221

Nm	Kgfm	lbf.ft	□ mm	L mm	LB mm	LS mm	g	
60÷300	6÷30	50÷220	14x18	588	468,5	39,8	1230	
669N/30							333,00	1 006690230

Nm	Kgfm	lbf.ft	□ mm	L mm	LB mm	LS mm	g	
80÷400	8÷40	60÷295	14x18	588	563	39,8	2100	
669N/40							385,00	1 006690240

671B/C5

Jogo com 1 barra dinamométrica ref. 604B/5, 1 roquete reversível, 8 chaves de caixa sextavadas e 4 ponteiros boca



671B/C5					842,00		1 006710001
----------------	--	--	--	--	---------------	--	-------------

604B/5	1÷5 Nm
611	1/4
641	5-6-7-8 mm
900	4-5-5,5-6-7-8-9-10 mm

270x120x45 mm - 1,3 kg

671B/C10

Jogo com 1 barra dinamométrica ref. 604B/10, 1 roquete reversível, 8 chaves de caixa sextavadas e 4 ponteiros boca



671B/C10					842,00		1 006710002
-----------------	--	--	--	--	---------------	--	-------------

604B/10	2÷10 Nm
611	1/4
641	6-7-8-10 mm
900	4-5-5,5-6-7-8-9-10 mm

270x120x45 mm - 1,4 kg

671N/C10

barra dinamométrica 668N/10 e acessórios



671N/C10					950,00		1 006710110
-----------------	--	--	--	--	---------------	--	-------------

668N/10	100 Nm
612	3/8
617	3/8
642	10-13-14-17-19 mm
652	10-13-14-17-19 mm
910A	3/8 8-10-11-13-14-17-19 mm
910/21	125 mm
910/22	250 mm

400x180x45 mm - 4,3 kg

671N/C20

barra dinamométrica 668N/20 e acessórios



671N/C20					1.007,00		1 006710120
-----------------	--	--	--	--	-----------------	--	-------------

668N/20	200 Nm
614	1/2
619	1/2
642	10-13-14-17-19 mm
652	10-13-14-17-19 mm
920A	1/2 10-11-13-14-17-19-22 mm
920/20	75 mm
920/21	125 mm
920/22	255 mm

510x180x45 mm - 5,5 kg

671N/C30

barra dinamométrica 668N/30 e acessórios



671N/C30					956,00		1 006710130
-----------------	--	--	--	--	---------------	--	-------------

668N/30	300 Nm
614	1/2
619	1/2
642	13-14-17-19 mm
652	13-14-17-19 mm
920A	1/2 13-14-17-19-22-24-27 mm
920/20	75 mm
920/21	125 mm
920/22	255 mm

620x180x45 mm - 5,8 kg

677

chaves dinamométricas com embraiagem e roquete simples para aperto direito e esquerdo precisão: $\pm 4\%$



UNI EN ISO 6789

Nm	Kgfm	lbf.ft	D mm	A mm	L mm	kg
100÷500	10÷50	70÷350	70	55	915	5,2

677/50 € 714,00 1 006770050

Nm	Kgfm	lbf.ft	D mm	A mm	L mm	kg
150÷700	15÷70	100÷500	70	55	1140	6,2

677/70 € 747,00 1 006770070

Nm	Kgfm	lbf.ft	D mm	A mm	L mm	kg
300÷1000	30÷100	200÷750	70	55	1470	7,5

677/100 € 774,00 1 006770100

677/C

chaves dinamométricas com roquetes móveis para aperto à esquerda e à direita, precisão de torque: $\pm 4\%$ fornecidas em estojo

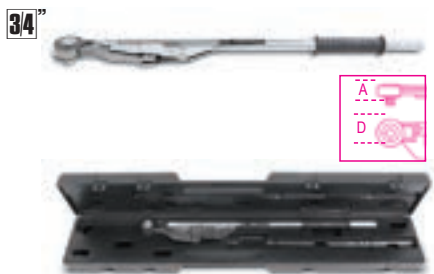

UNI EN 26789
ISO 6789

Nm	Kgfm	lbf.ft	D mm	A mm	L mm	kg
100÷500	10÷50	70÷350	70	55	915	5,2

677/C50 € 830,00 1 006770606

Nm	Kgfm	lbf.ft	D mm	A mm	L mm	kg
150÷700	15÷70	100÷500	70	55	1140	6,2

677/C70 € 863,00 1 006770611

Nm	Kgfm	lbf.ft	D mm	A mm	L mm	kg
300÷1000	30÷100	200÷750	70	55	1470	7,5

677/C100 € 992,00 1 006770615

Nm	Kgfm	lbf.ft	D mm	A mm	L mm	kg
700÷1500	70÷150	500÷1000	70	70	1475	10,4

677/C150 € 1.275,00 1 006770620

677/CP200

chave dinamométrica com embraiagem e roquete simples para aperto à direita e esquerda precisão: $\pm 4\%$ em estojo



UNI EN ISO 6789

Nm	Kgfm	lbf.in	D mm	A mm	L mm	kg
900÷2000	90÷200	600÷1500	70	63	1920	13

677/CP200 € 2.400,00 1 006770720

678/C

chaves dinamométricas com roquetes móveis para aperto à esquerda e à direita precisão $\pm 4\%$ fornecidas em estojo

• Modelos 678/C100 e 678/C150 fornecidos com extensões.

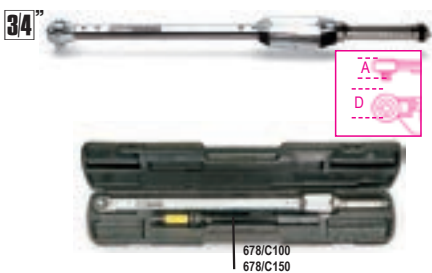

Nm	Kgfm	lbf.ft	D mm	A mm	L mm	kg
130÷650	13÷65	100÷480	63	55	885	3,9

678/C65 € 1.400,00 1 006780607

Nm	Kgfm	lbf.ft	D mm	A mm	L mm	kg
300÷1000	30÷100	220÷750	75	60	1250	6,0

678/C100 € 1.875,00 1 006780611

Nm	Kgfm	lbf.ft	D mm	A mm	L mm	kg
500÷1500	50÷150	370÷1100	75	60	1570	8,5

678/C150 € 2.065,00 1 006780615

677/CV - 678/CV

caixas metálicas para chaves dinamométricas modelos 677 e 678



677/CV1 € 116,00 1 006770450

677/C50-677/C70 € 109,00 1 006780500

678/CV2 € 218,00 1 006780415

677/C100-677/C150-678/C150 € 109,00 1 006780415

680

controlador eletrônico de binário Dynatester 680 para verificação da calibragem, possibilidade de utilização em sentido horário ou anti-horário

• Precisão: $\pm 1\%$
• 3 unidades de medida: Nm - lbf.ft. - lbf.in



	Nm	kg	€		
680/2,5	1÷25	2,6	1.885,00	1	006800002
680/40	15÷400	4,0	1.895,00	1	006800040
680/100	100÷1000	4,8	2.710,00	1	006800100

682

controlador de binário electrónico digital com transdutor Dynatester 682, para uso à direita e à esquerda

Alta precisão de leitura
Fornecido com porta série RS-232 para impressoras



CARACTERÍSTICAS TÉCNICAS

Precisão de leitura: $\pm 1\%$ do valor lido

Unidades de medida seleccionáveis

Nm-dNm-cNm-Lbf.ft-Lbf.in-Ozf.in-Kgf.m-Kgf.cm-gf.cm

Alimentação: 90 a 264 V AC a 50/60 Hz

Dimensões: 235x185x185 mm

Tolerância de teste de acordo com a norma ISO 6789

Escala aceite para cada chave dinamométrica testada

Visor: Menu disponível em 11 línguas

Fornecido com todos os certificados necessários

Certificado de calibração com rastreabilidade UKAS

	Nm	kg	€		
682/60	1,2÷60	5,9	5.040,00	1	006820006
682/400	8÷400	6,1	5.120,00	1	006820040
682/1500	30÷1500	6,4	5.280,00	1	006820150